

PTS 810 Series Microminiature SMT Top Actuated

Features/Benefits

- 4.2 x 3.2 mm footprint
- 2.5 mm thickness
- High number of cycles
- Color coded actuators

Typical Applications

- Control panels
- Nomad devices
- Remote controls



Specifications

FUNCTION: momentary action
 CONTACT ARRANGEMENT: 1 make contact = SPST N.O.
 TERMINALS: J type for SMT
 TRAVEL: 160 & 260 gf: 0.15mm ± 0.1mm
 400 & 600 gf: 0.20mm ± 0.1mm

	Operating Force (gf)	Operating Life (operations)
PTS810 SJM 250 SMTR LFS	160 ± 50	150,000
PTS810 SJK 250 SMTR LFS	260 ± 70	50,000
PTS810 SJG 250 SMTR LFS	400 ± 100	100,000
PTS810 SJS 250 SMTR LFS	600 ± 150	150,000

Packaging

Switches in reels of 2,900 pieces.
 Dimensions of reels according to EIA 481B
 External diameter 330 mm

Electrical

MAXIMUM VOLTAGE: 16 VDC
 MAXIMUM CURRENT DC: 50 mA
 DIELECTRIC STRENGTH: 250 VA C (1mn)
 CONTACT RESISTANCE: ≤ 500 mΩ
 INSULATION RESISTANCE: ≥ 100 MΩ
 BOUNCE TIME: ≤ 10 ms

Environmental

OPERATING TEMPERATURE: -40°C to 85°C

Process

SOLDERING: This component is suited to the following methods:
 Infrared Reflow Soldering in accordance with IEC61760-1

NOTE: Specifications listed above are for switches with standard options.
 For information on specific and custom switches, consult Customer Service Center.

How To Order

Our easy build-a-switch concept allows you to mix and match options to create the switch you need. To order, select desired option from each category and place it in the appropriate box.

For any part number different from those listed above, please consult your local representative.

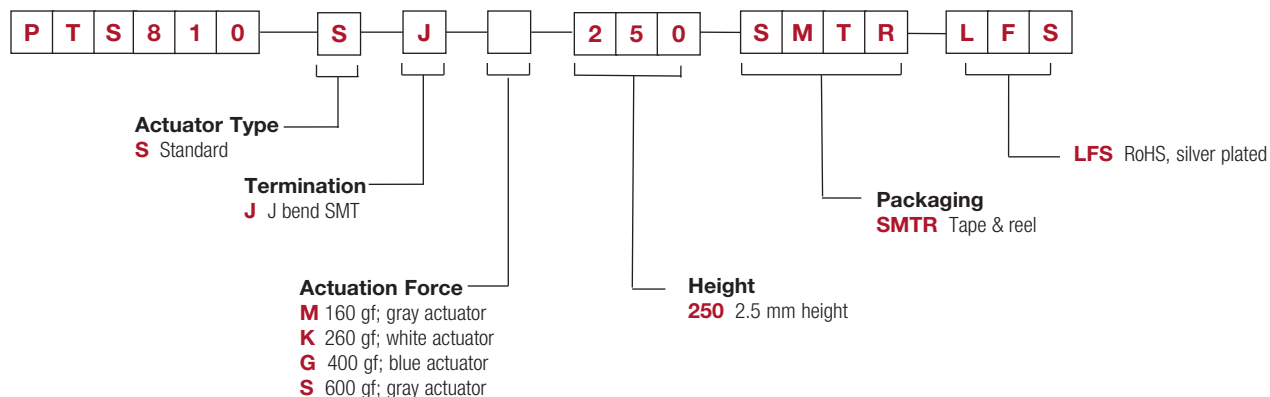

PTS 810 Series Microminiature SMT Top Actuated

PTS810

Tactile Switches

B

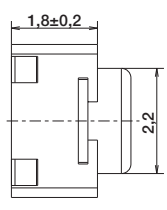
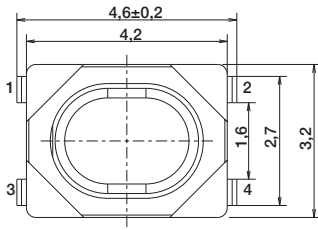
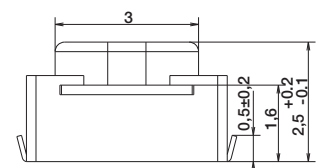

SCHEMATIC

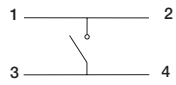

RECOMMENDED PCB LAYOUT

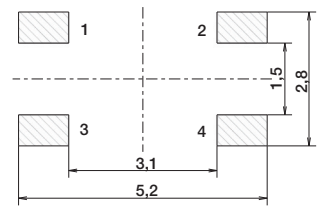

TAPE & REEL

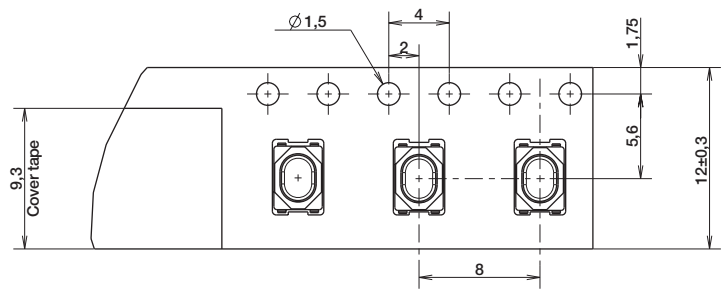

CARRIER TAPE

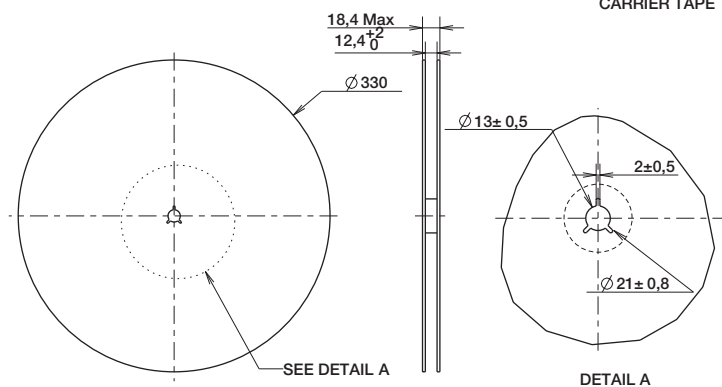

DETAIL A
SCALE 0,5

REEL



X-ON Electronics

Largest Supplier of Electrical and Electronic Components

Click to view similar products for [Switch Bezels / Switch Caps](#) category:

Click to view products by [C&K](#) manufacturer:

Other Similar products are found below :

[896809000](#) [LW1A-B2-R](#) [LW2A-B1-G](#) [704.604.4](#) [704.955.3](#) [F1403](#) [7527](#) [760203000](#) [760503000](#) [766601000](#) [785105000](#) [785106000](#)
[79211759](#) [MH11](#) [MH13](#) [MHU31](#) [MJ1216](#) [MJ1226](#) [MJ33](#) [MJ612](#) [MJ626](#) [MJ627](#) [9001T8BK](#) [908-1634](#) [92-343.200](#) [92-343.400](#) [95804.920](#)
[95CAP-011](#) [95CAP-112](#) [11-932.7](#) [99-901.9](#) [99-909.4](#) [99-909.5](#) [99-920.8](#) [A0261A](#) [11-931.2](#) [11-932.5](#) [11-936](#) [11-937](#) [AKTSC22B](#) [AT496H](#)
[AW-RF8](#) [161006](#) [1825068-6](#) [184-1872](#) [187-1872](#) [188-1471](#) [18-920.1](#) [C1103](#) [1DFBLK](#)