

SR 3 Switch Rockers were developed to provide the reliability required in demanding environmental conditions such as multifunction grips, dashboards or armrest controls for heavy duty industrial applications.

The switching system is distinguished by its high reliability with a life expectation of at least one million operations. The rocker modules have been designed for the typical switching function in 'off-road' machinery and other rough environments.



## Main Features

- Life greater than 1 million cycles
- Precise tactile feedback of switches
- Protection Class IP65
- K12 switch technology for high reliability

Electrical Data		
Switching current max.	Switch 1 Switch 2	S1: 7 mA (1K3 Ohm) S2: 9 mA (680 Ohm)
Mechanical Data		
Life	1 million cycles	
Operating temperature		
- Storage	- 40°C to 85°C	
- Working	- 35°C to 70°C	
Operating force	5 N	
Vertical load maximum	30 N	
Protection Level	IP 65 (from above when mounted)	
Rocker deflection angle	± 12°	

Ordering code		1	2	3	4	5	6	7	
	<b>Example</b>	SR3S	01	GY	5N/5N	01	R	00	M
<b>1 Type</b>	SR3 = switch rocker 3 S = varnished PCB N = non varnished PCB								
<b>2 Actuator Shape</b>	01 = long lever 02 = short lever 05 = thumb lever								
<b>3 Actuator Colour</b>	GY = grey								
<b>4 Operation Force</b>	5N/5N = 5 N left / 5N right								
<b>5 Switch assembly</b>	01 = switch 1 (S1) K12P BK 1 5N switch 2 (S2) K12P BK 1 5N								
<b>6 Output</b>	R = resistor (Ohm)								
<b>Output configuration</b>	00 = 0 Ohm 01 = S1: 1K3 Ohm S2: 680 Ohm								
<b>7 Mechanical function</b>	M = left / right momentary (center turn position)								

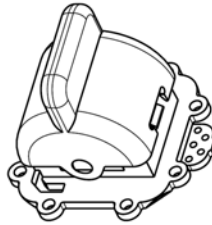
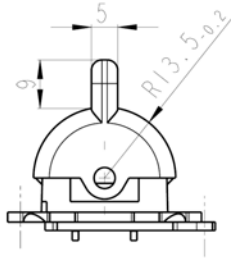

Module actuator shape 01

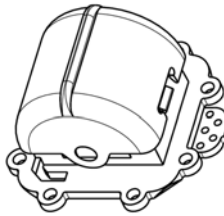
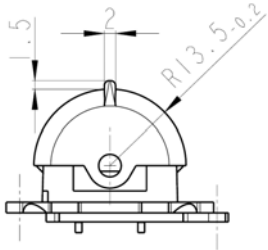

Module actuator shape 02

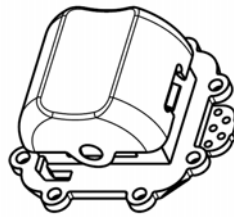
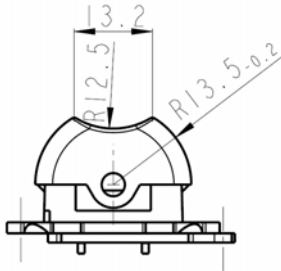

Module actuator shape 05

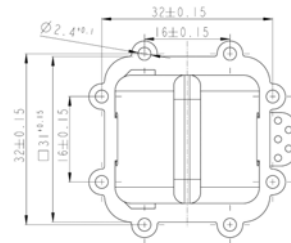
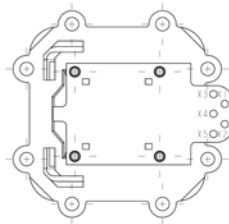
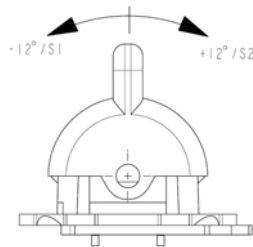

### Pin assignment:

PIN	ALLOCATION	FUNCTION
X5	S3_I S3_ext	RESERVED
X4	S3_VCC S3_ext	RESERVED
X3	S2_OUT	OUTPUT PUSHBUTTON S2
X2	S1_OUT	OUTPUT PUSHBUTTON S1
X1	VCC_IN	VOLTAGE SUPPLY

### Output configuration:

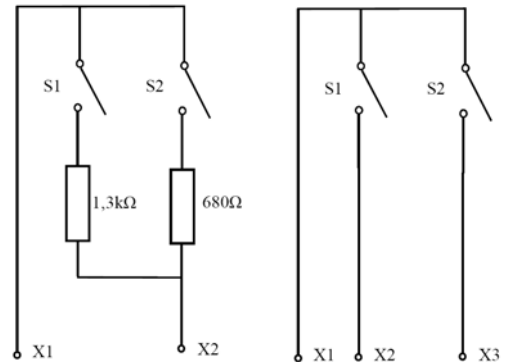

R01

R00

## X-ON Electronics

Largest Supplier of Electrical and Electronic Components

*Click to view similar products for [Rocker Switches](#) category:*

*Click to view products by [C&K](#) manufacturer:*

Other Similar products are found below :

[LTI LA6E-1S-WH-RC-FN12VXCR1](#) [6-1571986-9](#) [8007K26N324V52](#) [8055K32Z7V](#) [8055K52Z7V](#) [8138K20E6M50](#) [84206L](#) [84312LX](#)  
[PREDD5-07F-BB0GW](#) [999-16716-002](#) [999-16716-003](#) [999-16716-004](#) [A101J1V3Q004](#) [A101J2ZQ004](#) [A101J4ZQ004](#) [A101J51CB0004](#)  
[A103J1ZQ004](#) [A201J1AQ004](#) [A201J3ZB004](#) [A201J50ZQ004](#) [A203J51ZQ0004](#) [A435S1YZQ](#) [H8500XBBBBBL-A](#) [H8653VBBG2577W](#)  
[HB130CHNWWNAAC](#) [R13112ABB-602W](#) [1251.0303](#) [AE205J60V3B004](#) [1352.0107](#) [1571099-3](#) [1571987-4](#) [1571987-5](#) [1571989-7](#)  
[1571988-5](#) [B123J77V7B2](#) [B226J50W4Q22P](#) [B433J37ZQ22M](#) [160212E](#) [1634200-7](#) [1801.1164](#) [1839.1502](#) [PANEL-PLUG-VHP-BLACK](#)  
[PANEL-PLUG-VHP-WT](#) [K1ABBSCADN](#) [KG312A2DXD246X](#) [250011E714](#) [2600HM11E](#) [2600R21E](#) [2637LH/2A7/122048L0](#)  
[2639LH/2A7/127000L0](#)