

T Series Subminiature Rocker Switches

Features/Benefits

- Compact size—small footprint
- Single and double pole models
- PC and panel mounting options available
- RoHS compliant

Typical Applications

- Telecommunications
- Instrumentation
- Medical Equipment

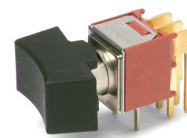
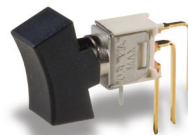

Models Available

Specifications

CONTACT RATING: Q contact material (TX01 models): 3 AMPS @ 120 V AC or 28 V DC. All other models: 2 AMPS @ 120 V AC or 28 V DC. See page G-49 for additional ratings.

ELECTRICAL LIFE: TX01 models: 60,000 make-and-break cycles at full load. All other models: 30,000 cycles.

CONTACT RESISTANCE: Below 20 m Ω typ. initial @ 2–4 V DC, 100 mA, for both silver and gold plated contacts.

INSULATION RESISTANCE: 10⁹ Ω min.

DIELECTRIC STRENGTH: 1000 Vrms min. @ sea level.

OPERATING TEMPERATURE: –30°C to 85°C.

SOLDERABILITY: Per MIL-STD-202F method 208D, or EIA RS-186E method 9 (1 hour steam aging).

NOTE: Any models supplied with B, G, P, Q or R contact material are RoHS compliant.

NOTE: Specifications and materials listed above are for switches with standard options. For information on specific and custom switches, consult Customer Service Center.

Materials

CASE: Glass filled nylon 6/6, flame retardant, heat stabilized or diallyl phthalate (DAP), (UL 94V-0) or glass filled nylon 4/6, flame retardant, heat stabilized.

ACTUATOR: Nylon, black standard.

BUSHING: Brass, nickel plated.

HOUSING: Stainless steel.

SWITCH SUPPORT: Brass, matte-tin plated.

MOUNTING BRACKET: Stainless steel.

END CONTACTS: B contact material: Copper alloy, with gold plate over nickel plate. Q contact material: Coin silver, silver plated. See page G-49 for additional contact materials.

CENTER CONTACTS & TERMINALS: B contact material: Copper alloy, with gold plate over nickel plate. Q contact material: Copper alloy, silver plated. See page G-49 for additional contact materials.

TERMINAL SEAL: Epoxy.

HARDWARE: Nut, Screws & Lockwasher: Stainless steel.
Standoff: Nylon standard.

Build-A-Switch

To order, simply select desired option from each category and place in the appropriate box. Available options are shown and described on pages G-46 through G-50. For additional options not shown in catalog, consult Customer Service Center. All models have epoxy terminal seal and are compatible with all “bottom-wash” PCB cleaning methods.

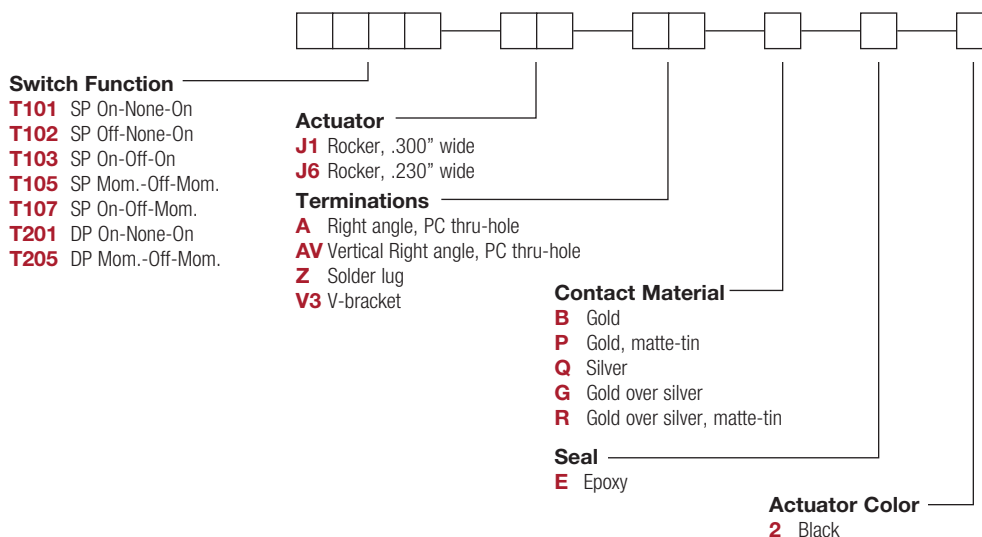

T Series Subminiature Rocker Switches

ACTUATOR COLOR

SWITCH FUNCTION



NO. POLES	MODEL NO.	SWITCH FUNCTION			CONNECTED TERMINALS			SCHEMATIC
		POS. 1	POS. 2	POS. 3	POS. 1	POS. 2	POS. 3	
		C&K marking on opposite side			C&K marking on opposite side			
SP	T101	ON	NONE	ON	2-3	N/A	2-1	
	T103	ON	OFF	ON		OPEN		
	T105	MOM.	OFF	MOM.				
	T107	ON	OFF	MOM.				
	T102	OFF	NONE	ON	OPEN	N/A	3-1	

SPDT

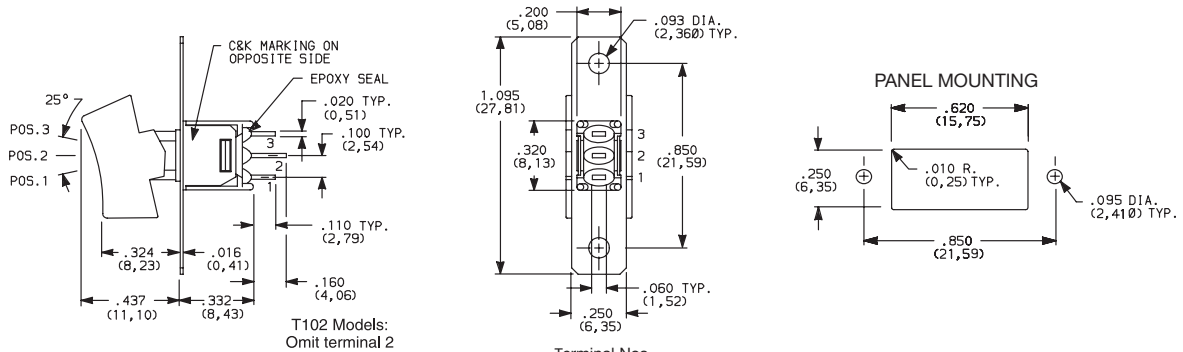

Part number shown: T101J6ZBE2

T102 Models:
Omit terminal 2

Terminal Nos.
For Reference Only

DP	T201	ON	NONE	ON	2-3,5-6	N/A	2-1,5-4	
	T205	MOM.	OFF	MOM.		OPEN		

DPDT

DPDT

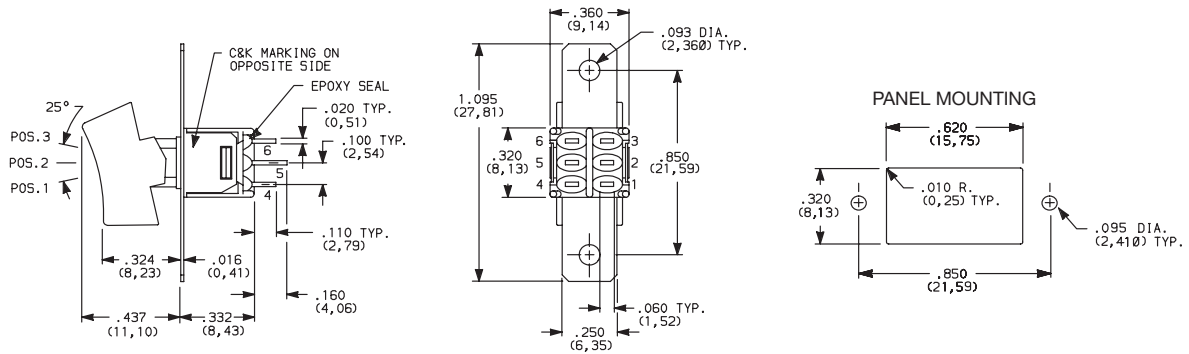

Part number shown: T201J1ZBE2

Terminal Nos.
For Reference Only

MOM. = Momentary

All models with all options when ordered with G, Q or R contact material.

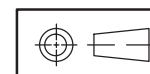

Third Angle
Projection

Dimensions are shown: Inches (mm)
Specifications and dimensions subject to change



T Series Subminiature Rocker Switches

ACTUATOR

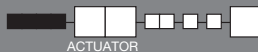

J1 ROCKER, .300 WIDE

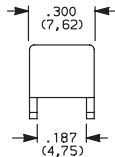
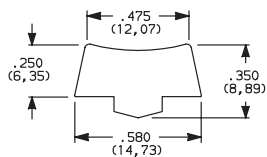

PANEL MOUNTING

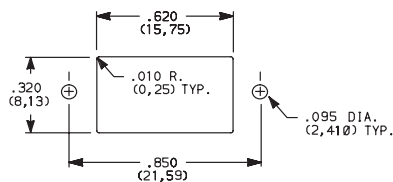

Standard with all models except T10X with A terminations.

J6 ROCKER, .230 WIDE

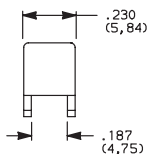
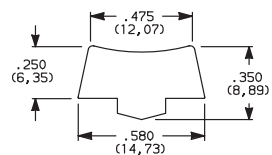

PANEL MOUNTING

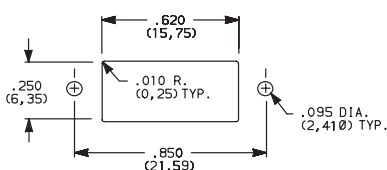

Standard with T10X model with A terminations.

OPTION CODE	ACTUATOR COLOR
2	BLACK

Actuators available separately, see page G 50. Finish: Matte. Other colors, custom actuator markings and legends available, consult Customer Service Center.

TERMINATIONS



Z SOLDER LUG

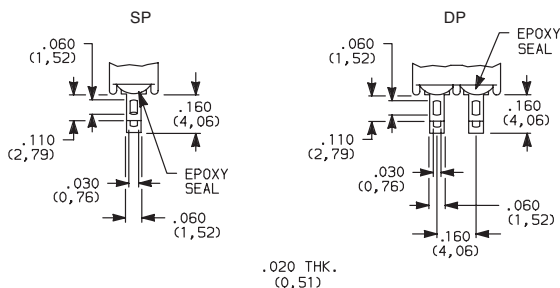

SP and DP

Not available with P or R contact material.

A RIGHT ANGLE, PC THRU-HOLE

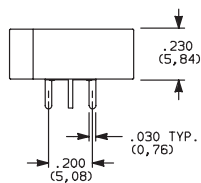

Actuator Shown In Pos. 1

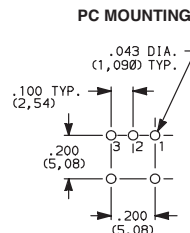
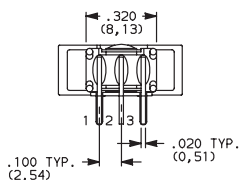
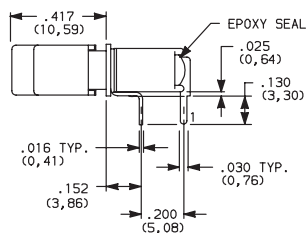

T101J6ABE2
Horizontal Actuation
SPDT

Not available with T102 model. J6 actuator standard only on T10X models with A terminations.



Third Angle
Projection

Dimensions are shown: Inches (mm)
Specifications and dimensions subject to change

Rocker

G

C&K

T Series Subminiature Rocker Switches

TERMINATIONS

A RIGHT ANGLE, PC THRU-HOLE

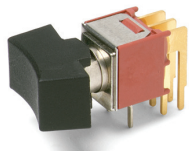

T201J1ABE2
Horizontal Actuation
DPDT

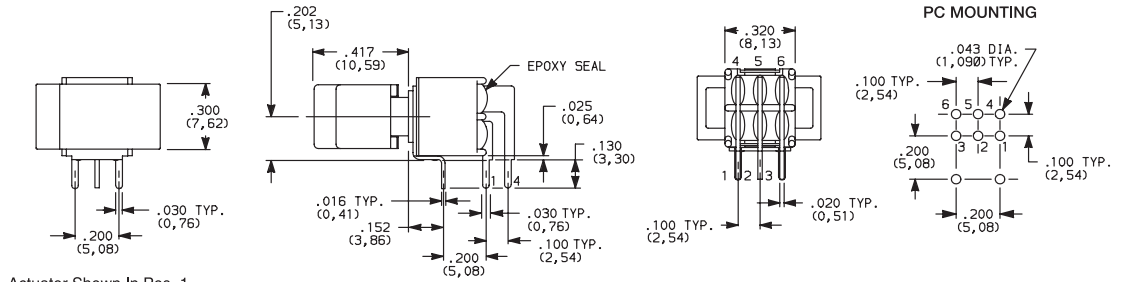

AV VERTICAL RIGHT ANGLE, PC THRU-HOLE

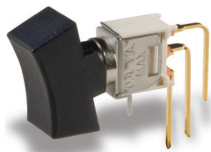

T101J1AVBE2
Vertical Actuation
SPDT

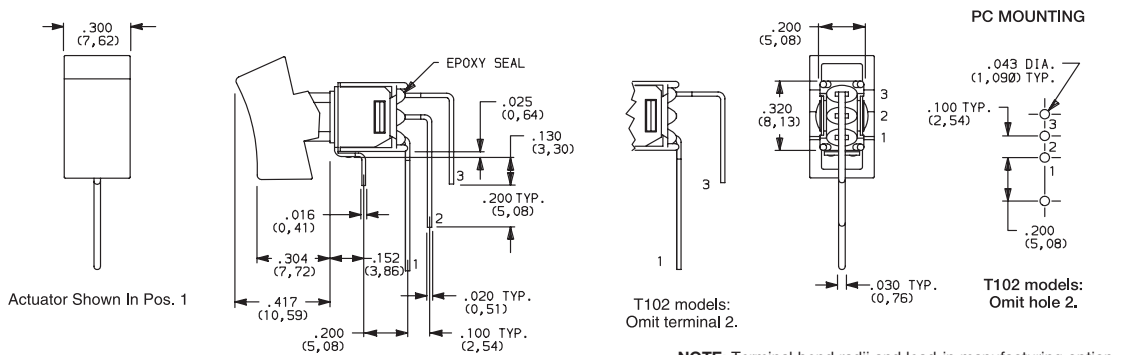

NOTE: Terminal bend radii and lead-in manufacturing option.

AV VERTICAL RIGHT ANGLE, PC THRU-HOLE

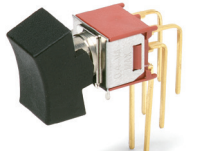

T201J1AVBE2
Vertical Actuation
DPDT

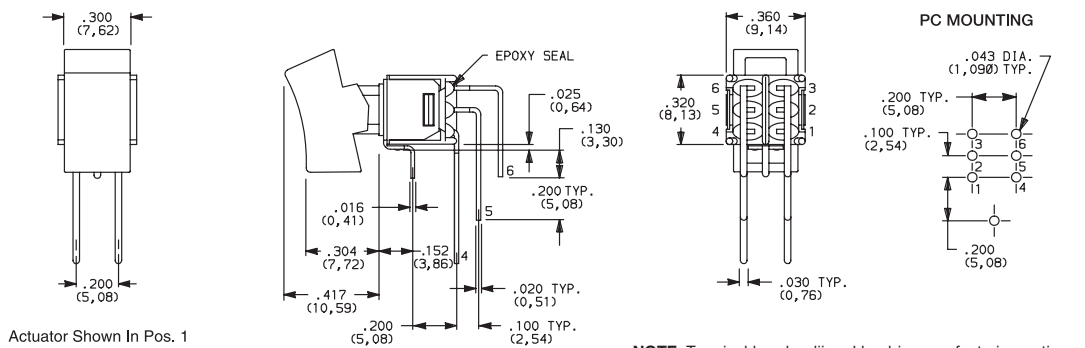

NOTE: Terminal bend radii and lead-in manufacturing option.

V3 VERTICAL MOUNT, V-BRACKET



T101J1V3BE2
SPDT

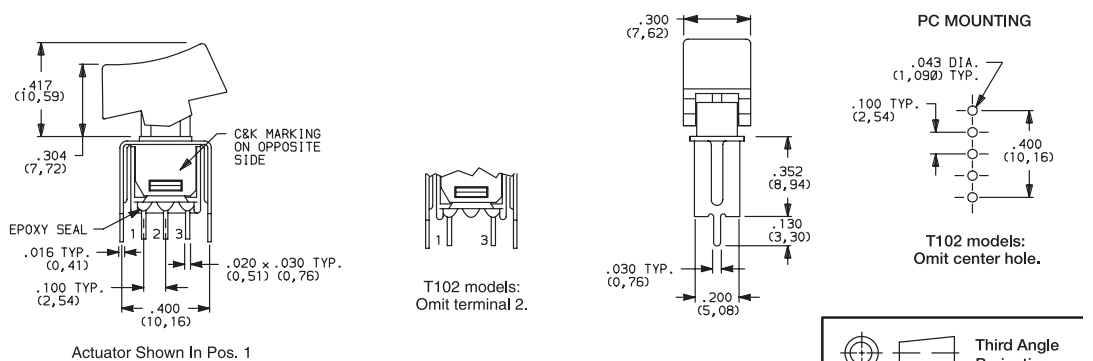

Actuator Shown In Pos. 1

T102 models:
Omit terminal 2.

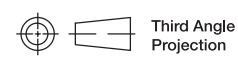

Dimensions are shown: Inches (mm)
Specifications and dimensions subject to change



T Series Subminiature Rocker Switches

TERMINATIONS

V3 VERTICAL MOUNT, V-BRACKET

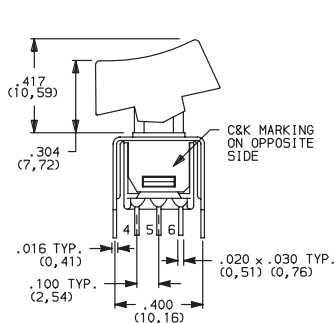

Actuator Shown In Pos. 1

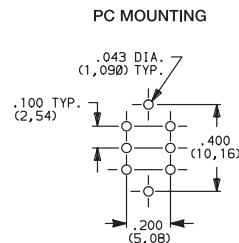
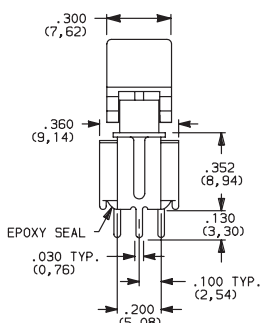

T201J1V3BE2
DPDT

CONTACT MATERIAL

OPTION CODE	CONTACT MATERIAL	TERMINAL PLATING	RATINGS	
B	GOLD ³	GOLD ¹	LOW LEVEL/ DRY CIRCUIT	0.4 VA MAX. @ 20 V AC OR DC MAX.
P		MATTE-TIN ⁶		
Q	SILVER ^{4,5}	SILVER ⁵	POWER	TX01 MODELS: 3 AMPS @ 120 V AC OR 28 V DC. ALL OTHER MODELS: 2 AMPS @ 120 V AC OR 28 V DC.
G	GOLD OVER SILVER ^{2,3}	GOLD ³	LOW LEVEL/DRY CIRCUIT OR POWER	TX01 MODELS: 0.4 VA MAX @ 20 V AC OR DC MAX. OR 3 AMPS @ 120 V AC OR 28 V DC. ALL OTHER MODELS: 0.4 VA MAX @ 20 V AC OR DC MAX. OR 2 AMPS @ 120 V AC OR 28 V DC.
R		MATTE-TIN ⁶		

* Note: See Technical Data section of this catalog for RoHS compliant and compatible definitions and specifications.

- CONTACTS & TERMINALS: Copper alloy, with gold plate over nickel plate.
- END CONTACTS: Coin silver, with gold plate over nickel plate.
- CENTER CONTACTS & ALL TERMINALS: Copper alloy, with gold plate over nickel plate.
- END CONTACTS: Coin silver, silver plated.
- CENTER CONTACT & ALL TERMINALS: Copper alloy, silver plated.
- TERMINALS: Copper alloy, with matte-tin over nickel plate.

NOTE: Any models supplied with B, G, P, Q & R contact material are RoHS compliant.

All models with all options when ordered with G, Q, or R contact material.

B contact material standard with A, AV, V3 terminations.

Q contact material standard with C & Z terminations.

P & R contact materials not available with Z terminations.

SEAL

E EPOXY SEAL

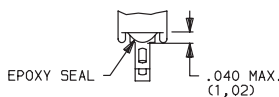

T Series Subminiature Rocker Switches

AVAILABLE HARDWARE

Panel mounting hardware for rocker and lever handle switches is available separately. Mounting hardware consists of two screws, two nuts, two standoffs and two lockwashers per switch, and is available for panel thicknesses of 1/16, 3/32 and 1/8 inch. See part numbers below.

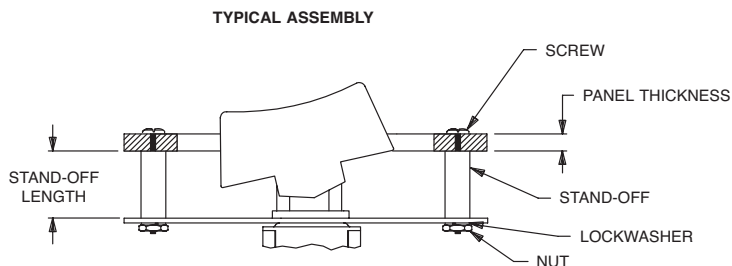

PART NO.	PANEL THK.	STANDOFF LENGTH
761101000	1/16 IN. (1,59)	.295 (7,49)
761102000	3/32 IN. (2,38)	.264 (6,71)
761103000	1/8 IN. (3,18)	.233 (5,92)

NOTE: Additional nuts, screws and lockwashers available separately, see Technical Data section of this catalog.

J1 Actuator



PART NO.
468002263 BLACK

Material: Nylon
Finish: Matte

J6 Actuator



PART NO.
468102263 BLACK

Material: Nylon
Finish: Matte

NOTE: Other colors, custom actuator markings and legends available, consult Customer Service Center.

X-ON Electronics

Largest Supplier of Electrical and Electronic Components

Click to view similar products for [Rocker Switches](#) category:

Click to view products by [C&K](#) manufacturer:

Other Similar products are found below :

[LTI LA6E-1S-WH-RC-FN12VXCR1](#) [6-1571986-9](#) [8007K26N324V52](#) [8055K23Z7V](#) [8055K32Z7V](#) [8055K52Z7V](#) [8138K20E6M50](#) [84206L](#)
[84312LX](#) [PREDD5-07F-BB0GW](#) [999-16716-002](#) [999-16716-003](#) [999-16716-004](#) [A101J1V3Q004](#) [A101J2ZQ004](#) [A101J4ZQ004](#)
[A101J51CB0004](#) [A103J1ZQ004](#) [A201J1AQ004](#) [A201J3ZB004](#) [A201J50ZQ004](#) [A203J51ZQ0004](#) [A435S1YZQ](#) [H8500XBBBBL-A](#)
[H8653VBBG2577W](#) [HB130CHNWWNAAC](#) [R13112ABB-602W](#) [1251.0303](#) [AE205J60V3B004](#) [1352.0107](#) [1571099-3](#) [1571987-4](#)
[1571987-5](#) [1571989-7](#) [1571988-5](#) [B123J77V7B2](#) [B226J50W4Q22P](#) [B433J37ZQ22M](#) [160212E](#) [1634200-7](#) [1801.1164](#) [1839.1502](#) [PANEL-](#)
[PLUG-VHP-BLACK](#) [PANEL-PLUG-VHP-WT](#) [K1ABBSCADN](#) [KG312A2DXD246X](#) [250011E714](#) [2600HM11E](#) [2600R21E](#) [260413E](#)