

KSS Series Subminiature SMT Side Actuated

Features/Benefits

- Low profile of 1.7 mm
- Excellent tactile feel
- High shear force
- Range of actuation forces
- Large flat top
- RoHS compliant and compatible

Typical Applications

- Cellular phone
- Industrial electronics
- Health diagnostic electronics

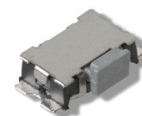

Specification

FUNCTION: momentary action
CONTACT ARRANGEMENT: N.O.
TERMINALS: Gullwing
IP40 sealed

Mechanical

OVERLOAD: 20N
TACTILE FEELING: 2 and 4N: 25% min.
2.5N: 30% min.

| Type | Operating force Newtons (grams) | Operating life (operations) | Travel (mm) |
|---------|------------------------------------|--------------------------------|----------------|
| KSS221G | 2.0 (200) ± 0.5 | 100,000 | 0,3 ± 0,15 |
| KSS231G | 2.5 (250) ± 0.5 | 100,000 | 0,3 ± 0,10 |
| KSS241G | 4.0 (400) ± 1.0 | 100,000 | 0,3 ± 0,15 |

NOTE: Specifications listed above are for switches with standard options.
For information on specific and custom switches, consult Customer Service Center.

Electrical

| | Silver | Gold |
|----------------------------------|-----------|--------|
| MAXIMUM POWER: | 1 VA | 0.2 VA |
| MAXIMUM VOLTAGE: | 32 VDC | 32 VDC |
| MAXIMUM CURRENT: | 50 mA | 10 mA |
| MINIMUM CURRENT: | 1 mA | 1 mA |
| DIELECTRIC STRENGTH: | ≥ 250 VDC | |
| CONTACT RESISTANCE: | < 100 mΩ | |
| INSULATION RESISTANCE (100 VDC): | ≥ 10° Ω | |
| BOUNCE TIME: | < 3 ms | |

Environmental

| | Silver | Gold |
|------------------------|---------------|----------------|
| OPERATING TEMPERATURE: | -40°C to 85°C | -40°C to 125°C |
| STORAGE TEMPERATURE: | -55°C to 85°C | -55°C to 125°C |

Process

Soldering: Lead free reflow soldering process in accordance with IEC 61760-1.

Packaging

Tape and reels in reels of 3,000 pieces.
External diameter 330mm ± 2mm.

How To Order

Our easy build-a-switch concept allows you to mix and match options to create the switch you need. To order, select desired option from each category and place it in the appropriate box.

However, please note that all the combinations of these options are not feasible.

For any part number different from those listed above, please consult your local representative.

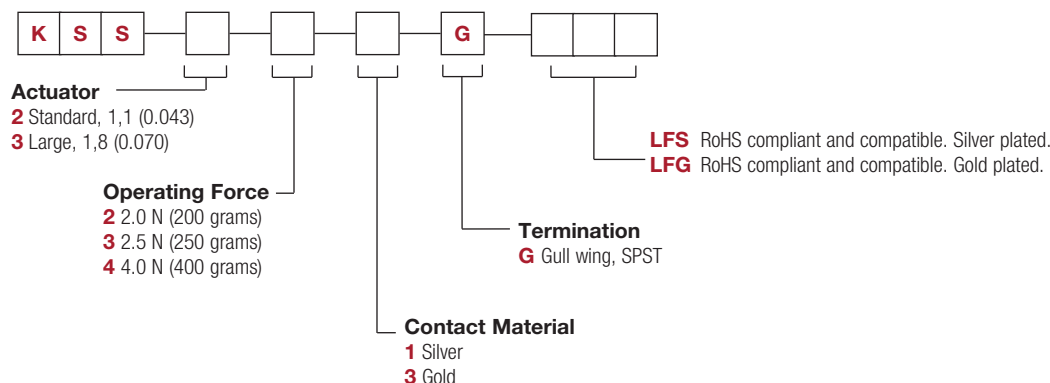

KSS Series Subminiature SMT Side Actuated

KSS

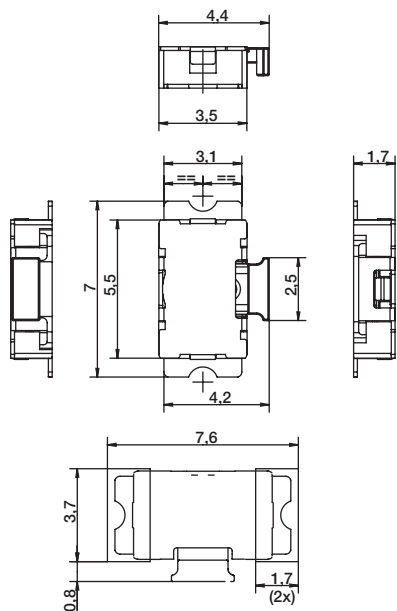

Tactile Switches

B

ACTUATOR

2 STANDARD, 1,1 (0.043)

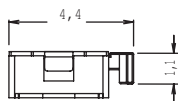

3 LARGE, 1,8 (0.070)

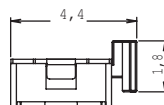

TAPE & REEL

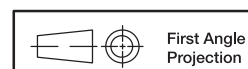
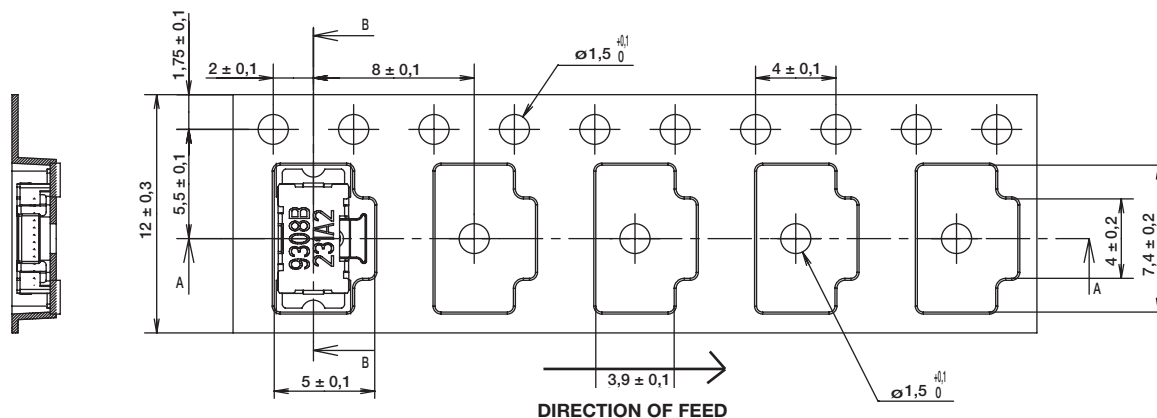

First Angle
Projection

Dimensions are shown: mm
Specifications and dimensions subject to change

X-ON Electronics

Largest Supplier of Electrical and Electronic Components

Click to view similar products for [Switch Accessories](#) category:

Click to view products by [C&K](#) manufacturer:

Other Similar products are found below :

[896809000](#) [01500](#) [01010](#) [01501](#) [7101MD9V30B](#) [7103KZBE](#) [7103P3YAVGE](#) [7209MD9ABE](#) [7209SY9AQE](#) [7209SYCBE](#) [7303KZQE](#)
[F1302](#) [F1403](#) [760201000](#) [764300000](#) [785105000](#) [785106000](#) [789009000](#) [7T0062](#) [7T0073](#) [MJ1216](#) [MJ33](#) [MJ612](#) [849PT01A](#)
[91321314655637182-1-MEV](#) [A0107X](#) [A0141A](#) [A0141E](#) [A0142M2SP](#) [A0142N5](#) [A0143G](#) [A0143H](#) [A0161G](#) [A0162A](#) [A0162F](#) [A019307](#)
[A01RTC8](#) [A0214X](#) [A0215X](#) [A02504](#) [A02512](#) [A0261A](#) [A0263D](#) [A029303](#) [A02MXB](#) [A168P1](#) [A274](#) [A3A-7310](#) [A3PA571124E](#) [A466](#)