



Product Catalogue 2017

DESIGNED FOR PROFESSIONALS

For over 100 years, C.K has been at the forefront of hand tool manufacturing, producing high quality tools that meet the most demanding needs of trade professionals.

Backed by a lifetime guarantee, C.K tools are engineered to offer leading performance, durability, accuracy and strength, all of which are key requirements for professional results.

Driven by research through an extensive panel of cross trade professionals, tools are developed to assist with every day tasks; an approach proven to produce innovative tools that transform traditional working practices.



Pliers & Cutters 02-23

Screwdrivers 24-45

Electrician's Tools 46-63

Building & Plumbing 64-85

Measuring & Marking 86-95

Sawing & Cutting 96-107

Sockets, Spanners & Wrenches 108-119

Engineer's Tools 120-129

Power Tool Accessories 130-159

Watering Systems 160-167

ESD & Precision Tools 168-205

Torches & Lamps 206-209





REDLINE VDE

04-08

PVC CUTTERS

21

REDLINE

09-11

PINCERS & TOP CUTTERS

21

CLASSIC

12-13

HEAVY DUTY CUTTERS

22-23

WATERPUMP PLIERS

14

PUNCH PLIERS

23

CRIMPING PLIERS

15-18

CIRCLIP PLIERS

18-19

RIVETING PLIERS & RIVETS

19-20



PLIERS & CUTTERS



REDLINE VDE

PREMIUM QUALITY INSULATED PLIERS & CUTTERS



- 1 Two component, ergonomic design, with anti-slip horns for increased comfort, control and safety
- 2 Induction hardened jaws for outstanding long term performance
- 3 Cutting jaws with C.K optimised geometry for unsurpassed cutting performance
- 4 Special alloy steel, drop forged, hardened and tempered for exceptional strength and durability
- 5 VDE approved - individually tested to 10,000V for safe live working up to 1,000V



RedLine™ VDE

Conforms to IEC 60900. Approved and independently audited by the German VDE institute.

COMBICUTTER

IT STRIPS, IT BENDS, IT SHEARS



Specially designed for electrical installation work these award winning cutters have transformed the way in which electricians work and have become the number one choice of professionals.

IT STRIPS

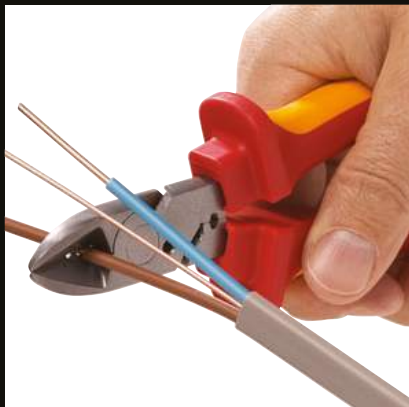

Wire stripping notches -
for effortless and damage
free stripping of 1.5 and
2.5mm² wire

IT BENDS



Wire bending anvil -
for quick and damage
free doubling back of
copper wire

IT SHEARS



Patress screw shear –
for damage free cutting
of patress screws

REDLINE VDE



VDE Combicutter1

Patress screw shear for damage free cutting of 3.5mm patress screws.
EN 60900, ISO 5749, VDE0682/201, ASTM-F 1505

Item Number	←→	○	◐	◑	◒
431004	160mm (6")	2.0mm	2.8mm	>4.0mm	3



VDE Combicutter3

Wire stripping notches for effortless & damage free stripping of 1.5 & 2.5mm² wire. Wire bending anvil for quick & damage free doubling back of copper wire. Patress screw shear for damage free cutting of 3.5mm patress screws.

EN 60900, ISO 5749, VDE0682/201, ASTM-F 1505

Item Number	←→	○	◐	◑	◒
431008	160mm (6")	2.0mm	2.8mm	>4.0mm	3



VDE Combicutter1MAX

Patress screw shear for damage free cutting of 3.5mm patress screws & 4mm conduit cover screws.

EN 60900, VDE0682/201, ASTM-F 1505

Item Number	←→	○	◐	◑	◒
T39071-1180	180mm (7")	2.5mm	3.0mm	>4.0mm	3



VDE Combicutter3MAX

Wire stripping notches for effortless & damage free stripping of 1.5 & 2.5mm² wire. Wire bending anvil for quick & damage free doubling back of copper wire. Patress screw shear for damage free cutting of 3.5mm patress screws & 4mm conduit cover screws.

EN 60900, VDE0682/201, ASTM-F 1505

Item Number	←→	○	◐	◑	◒
T39071-3180	180mm (7")	2.5mm	3.0mm	>4.0mm	3



VDE Combicutter2

Wire stripping notches for effortless & damage free stripping of 1.5 & 2.5mm² wire. Patress screw shear for damage free cutting of 3.5mm patress screws.

EN 60900, ISO 5745, VDE0682/201, ASTM-F 1505

Item Number	←→	○	◐	◑	◒
431009	160mm (6")	2.0mm	2.8mm	>4.0mm	3



VDE Side Cutters - Wire Stripping

Wire stripping notches for effortless & damage free stripping of 1.5 & 2.5mm² wire.

EN 60900, ISO 5749, VDE0682/201, ASTM-F 1505

Item Number	←→	○	◐	◑	◒
431019	160mm (6")	2.0mm	2.8mm	>4.0mm	3



VDE Side Cutters - Standard

EN 60900, ISO 5749, VDE0682/201, ASTM-F 1505

Item Number	↔	○	⊘	⊘	📦
431018	140mm (5 1/2")	1.4mm	1.9mm	>4.0mm	3
431017	160mm (6")	2.0mm	2.8mm	>4.0mm	3
431005	180mm (7")	2.5mm	3.0mm	>4.0mm	3



VDE Electrician's Pliers

EN 60900, VDE0682/201, ASTM-F 1505

Item Number	↔	○	⊘	⊘	📦
T39077-180	180mm (7")	1.6mm	2.5mm	>4.0mm	3



VDE Side cutters - High Leverage

EN 60900, VDE0682/201, ASTM-F 1505

Item Number	↔	○	⊘	⊘	📦
T37021 180	180mm	2.2mm	3.8mm	6mm	3
T37021 200	200mm	2.5mm	4.2mm	6mm	3



VDE Cable Cutters

Shearing action for clean cut results. Razor sharp, parrot beak blades for effortless cuts. Suitable for copper & aluminium wire only.

EN 60900, VDE0682/201, ASTM-F 1505

Item Number	↔	⊘	📦
431030	160mm (6")	15.0mm	3
431031	210mm (8 1/4")	20.0mm	3

VDE ELECTRICIAN'S PLIERS



1 Tapered nose - streamlined for better access, and ideal for gripping nuts and cutting wires in recessed cabinets

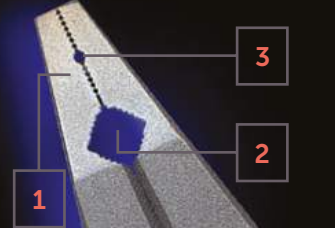

2 Gutter nut holder - specially profiled jaw for securely holding square nuts used on cable trays and cabinets



3 Pin holder - machined at 90° to the angled face for holding cable clips/nails upright while hammering





VDE Combination Pliers

Precision engineered jaws for exceptional grip. Extra long cutting edges for increased cutting capacity.

EN 60900, ISO 5746, VDE0682/201, ASTM-F 1505

Item Number	↔	○	⊘	⊘	📦
431001	165mm (6 1/2")	1.6mm	2.5mm	>4.0mm	3
431002	185mm (7")	1.6mm	2.5mm	>4.0mm	3
431003	205mm (8")	2.0mm	2.8mm	>4.0mm	3



VDE Wire Stripping Pliers

Micro adjustment for damage free repeatable results. Spring assisted opening for convenience.

EN 60900, VDE0682/201, ASTM-F 1505

Item Number	↔	⊘	📦
431012	160mm (6")	0.3 - 0.5mm	3



VDE Snipe Nose Pliers - Straight

Serrated inside jaws for secure gripping.

EN 60900, ISO 5745, VDE0682/201, ASTM-F 1505

Item Number	↔	○	⊘	⊘	📦
431013	175mm (6 1/2")	1.4mm	2.0mm	>4.0mm	3
431014	200mm (8")	1.6mm	2.0mm	>4.0mm	3



VDE Pliers Set - 3 Piece

CONTENTS:

- 1 x Combination pliers 180mm.
- 1 x Combicutter 160mm.
- 1 x Snipenose pliers 200mm.

Item Number	i	📦
T3805	Set of 3	1



VDE Snipe Nose Pliers - Bent

Serrated inside jaws for secure gripping. Bent nose for special access needs.

EN 60900, ISO 5745, VDE0682/201, ASTM-F 1505

Item Number	↔	○	⊘	⊘	📦
431015	200m (8")	1.6mm	2.5mm	>4.0mm	3



REDLINE PREMIUM QUALITY PLIERS & CUTTERS



- 1 Two component, ergonomic design, with anti-slip horns for increased comfort, control and safety
- 2 Induction hardened jaws for outstanding long term performance
- 3 Cutting jaws with C.K optimised geometry for unsurpassed cutting performance
- 4 Special alloy steel, drop forged, hardened and tempered for exceptional strength and durability



RedLine™

REDLINE



Side Cutters - Standard

ISO 5749

Item Number	↔	○	◐	◑	◒	◓
T3750 145	140mm (5 1/2")	1.4mm	1.9mm	>4.0mm	3	
T3750 160	160mm (6")	2.0mm	2.8mm	>4.0mm	3	
T3750 180	180mm (7")	2.5mm	3.0mm	>4.0mm	3	



Cable Cutters

Shearing action for clean cut results. Razor sharp, parrot beak blades for effortless cuts. Suitable for copper & aluminium wire only.

Item Number	↔	◐	◑	◒	◓
T3964 6	160mm (6")	15.0mm			3



Side Cutters - High Leverage

High leverage design for increased cutting capacity.

Item Number	↔	○	◐	◑	◒	◓
T3721 180	180mm (7")	2.2mm	3.8mm	>6.0mm	3	
T3721 200	200mm (8")	2.5mm	4.2mm	>6.0mm	3	



Combination Pliers

Precision engineered jaws for exceptional grip. Extra long cutting edges for increased cutting capacity.

ISO 5746

Item Number	↔	○	◐	◑	◒	◓
T3867 6	160mm (6")	1.6mm	2.5mm	>4.0mm	3	
T3867 7	180mm (7")	1.6mm	2.5mm	>4.0mm	3	
T3867 8	200mm (8")	2.0mm	2.8mm	>4.0mm	3	



Snipe Nose Pliers - Straight

Serrated inside jaws for secure gripping.

ISO 5745

Item Number					
T3909 5	140mm (5 1/2")	1.2mm	1.6mm	>4.0mm	3
T3909 6	170mm (6 3/4")	1.4mm	1.9mm	>4.0mm	3
T3906 8	200mm (8")	1.6mm	2.0mm	>4.0mm	3



Pliers Set - 3 Piece

CONTENTS:

- 1 x Combination pliers 180mm.
- 1 x Side cutters 160mm.
- 1 x Snipenose pliers 200mm.



Snipe Nose Pliers - Bent

Serrated inside jaws for secure gripping. Bent nose for special access needs.

ISO 5745

Item Number					
T3907 8	200mm (8")	1.6mm	2.0mm	>4.0mm	3

Item Number	
T3803	1



Wire Stripping Pliers

Micro adjustment for damage free repeatable results. Spring assisted opening for convenience.

ISO 5743

Item Number			
T3754	160mm (6")	0.3 - 0.5mm	3



Pliers Set - 3 Piece

CONTENTS:

- Wire stripping pliers 160mm.
- Side cutters 160mm.
- Snipenose pliers 200mm.

Item Number	
T3804	1

CLASSIC

PROFESSIONAL GENERAL PURPOSE PLIERS & CUTTERS



- 1 Induction hardened jaws for outstanding long term performance
- 2 High alloy steel, drop forged, hardened and tempered for exceptional strength and durability
- 3 Heads polished and lacquered for corrosion protection
- 4 Wipe clean PVC handles for added convenience



Classic™

CLASSIC



Side cutters - Standard

ISO 5749

Item Number	←→	○	◐	◑	◒	◓
T3623B 5	140mm (5 1/2")	1.2mm	1.6mm	>4.0mm	6	
T3623B 6	160mm (6")	1.6mm	2.1mm	>4.0mm	6	



Snipe Nose Pliers - Straight

Serrated inside jaws for secure gripping.

ISO 5745

Item Number	←→	○	◐	◑	◒	◓
T3622B	140mm (5 1/2")	1.4mm	1.9mm	>4.0mm	6	



Side Cutters - High Leverage

High leverage design for increased cutting capacity.

ISO 5749

Item Number	←→	○	◐	◑	◒	◓
T3627B 7	180mm (7")	2.2mm	3.8mm	>6.0mm	6	



Snipe Nose Pliers - Straight

Serrated inside jaws for secure gripping.

ISO 5745

Item Number	←→	○	◐	◑	◒	◓
T3626B 8	200mm (8")	1.6mm	2.0mm	>4.0mm	6	



Combination Pliers

Precision engineered jaws for exceptional grip. Extra long cutting edges for increased cutting capacity.

ISO 5746

Item Number	←→	○	◐	◑	◒	◓
T3621B 6	160mm (6")	1.6mm	2.5mm	>4.0mm	6	
T3621B 7	180mm (7")	1.6mm	2.5mm	>4.0mm	6	
T3621B 8	200mm (8")	2.0mm	2.8mm	>4.0mm	6	



Cable Cutters

Special alloy steel construction with razor sharp, induction hardened cutting edges for outstanding cutting performance. Special profile blade for effective cable cutting & wire stripping. Suitable for copper & aluminium wire only.

Item Number	←→	∅	◓
T3963 160	160mm (6")	9mm	3
T3963	210mm (8 1/4")	11mm	3
T3963 240	240mm (9 1/2")	13mm	3

WATERPUMP PLIERS



Waterpump Pliers - Speedlok

Special alloy steel, drop forged, hardened & tempered for exceptional strength & durability. 'Slide to adjust' mechanism for fast & accurate size adjustment. Slim head & jaws for access to confined spaces.

DIN ISO 8976

Item Number	↔	∅	📦
T3655 250	250mm (10")	38mm (1 1/2")	6
T3655 300	300mm (12")	55mm (2")	6



Waterpump Pliers - Heavy Duty

Special alloy steel, drop forged, hardened & tempered for exceptional strength & durability. Induction hardened jaws for long term performance. Box joint design with double pivot support for strength. Slim head & jaws for access to confined spaces.

DIN 8976

Item Number	↔	∅	📦
T3659A 175	180mm (7")	25mm (1")	3
T3659A 240	240mm (9 1/2")	32mm (1 1/4")	3
T3659A 300	300mm (12")	45mm (1 3/4")	3



Waterpump Pliers - Standard

Special alloy steel, drop forged, hardened & tempered for exceptional strength & durability. Induction hardened jaws for long term performance. Laid on slip joint design for secure adjustment.

DIN ISO 8976

Item Number	↔	∅	📦
T3651 09	250mm (10")	38mm (1 1/2")	3



Waterpump Pliers - High Capacity

Special alloy steel, drop forged, hardened & tempered for exceptional strength & durability. Chrome plated for protection. Induction hardened jaws for long term performance. 11 positions of adjustment offering a large gripping capacity of 110mm.

Item Number	↔	∅	📦
T3629A 400	400mm	110mm (4")	1



RedLine VDE Waterpump Pliers

Special alloy steel, drop forged, hardened & tempered for exceptional strength & durability. Box joint design with double pivot support for strength. Slim head & jaws for access to confined spaces. Double dipped VDE insulated handle for safety.

EN 60900, VDE 0682/201, ASTM-F 1505

Item Number	↔	📦
431016	250mm	3



RATCHET CRIMPING PLIERS

- 1 Auto-stop ratchet system releases when correct pressure is applied to ensure precise crimping
- 2 Precision engineered dies for quality crimps and safe connections
- 3 Dies manufactured from fully hardened carbon alloy steel for strength and durability
- 4 Heavy duty construction, tested up to 40,000 cycles, guaranteed for 30,000 crimps per tool
- 5 Ergonomic design for increased comfort and control



CRIMPING PLIERS

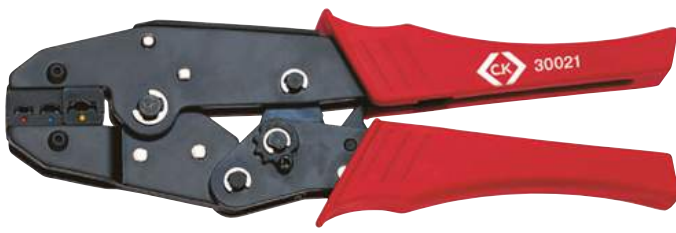

Ratchet Crimping Pliers - Insulated Terminals

Designed for the safe & secure crimping of red, blue or yellow insulated terminals.

Item Number			mm ² /AWG	
430021	✓	220mm	0.5 - 6.0 / 20 - 10	3



Ratchet Crimping Pliers - Bell Mouth Ferrules

Designed for the safe & secure crimping of bell mouth ferrules.

Item Number			mm ² /AWG	
T3676	✓	350mm	6 - 25 / 10 - 4	3



Ratchet Crimping Pliers - Insulated Terminals

Designed for the safe & secure crimping of green, red or blue insulated terminals.

Item Number			mm ² /AWG	
430019	✓	190mm	0.5 - 2.5 / 24 - 13	3



Ratchet Crimping Pliers - Small Ferrules

Designed for the safe & secure crimping of boot lace ferrules.

Item Number			mm ² /AWG	
430018	✓	190mm	0.14 - 2.5 / 26 - 14	3



Ratchet Crimping Pliers - Non-Insulated

Designed for the safe & secure crimping of non insulated terminals.

Item Number			mm ² /AWG	
430025	✓	230mm	1.5 - 10 / 16 - 8	3



Ratchet Crimping Pliers - Medium Ferrules

Designed for the safe & secure crimping of boot lace ferrules.

Item Number			mm ² /AWG	
430029	✓	190mm	0.25 - 6.0 / 20 - 10	3



Ratchet Crimping Pliers - Large Ferrules

Designed for the safe & secure crimping of boot lace ferrules.

Item Number			mm ² /AWG	
430022	✓	230mm	10 - 25 / 8 - 3	3



Ratchet Crimping Pliers - Coax, BNC, TNC

Designed for the safe & secure crimping of BNC/TNC connectors to coaxial cable.

Item Number				
430026	✓	230mm	For sizes 1.0, 1.69, 2.0, 3.25, 4.52 & 6.48mm / 0.39, 0.67, 0.78, 0.128, 0.178 & 0.255"	3



Ratchet Crimping Pliers - Modular Plugs 1

Designed for the safe & secure attachment of modular plugs without die changes. Built in wire stripper/cutter mechanism for convenience.

Item Number				
430020	✓	220mm	4P2C, 4P4C, 6P4C (RJ11), 6P6C (RJ12), 8P8C, (RJ45) and 6P6C/Offset	3



Ratchet Crimping Pliers Solar PV

Designed for the safe & secure crimping of Solar PV cable connectors.

Item Number			
T3671	220mm	MC3 & MC4	3



Ratchet Crimping Pliers - Modular Plugs 2

Designed for the safe & secure attachment of modular plugs without die changes. Built in wire stripper/cutter mechanism for convenience.

Item Number				
430028	✓	250mm	8P8C, (RJ45), 6P6C (RJ12) and 6P4C (RJ11)	3



Compact Crimper for Modular Plugs

Compact ergonomic design for convenient storage and easy handling. Crimps both 6 and 8 position modular connectors (including RJ11 and RJ45). Cuts and strips CAT3, CAT5e and flat cables. Heavy duty carbon steel body for strength and durability.

Item Number				
T3673	✓	140mm	6P & 8P	3



Crimping Pliers - Small Ferrules

Designed for the safe & secure crimping of boot lace ferrules. Hardened & tempered high alloy carbon steel for increased strength & durability. Matt chrome plated for corrosion protection. Contoured grips with anti-slip horns for comfort & safety .

Item Number			mm ² / AWG	
430005	✓	145mm	0.25 - 2.5 / 23 - 13	3
430006	✓	220mm	0.5 - 16 / 20 - 5	3



Crimping Pliers - Multi-Function

Manufactured from specially hardened steel for durability. Soft grip handles for comfort & safety. Four function tool for wire cutting, wire stripping, crimping and bolt/wire shearing

Item Number			
430024	250mm	Crimping of non-insulated terminals (Red, Blue & Yellow) Bolt shearing (0.75, 1.5, 2.5, 4, 6 mm ø) Wire stripping (0.75, 1.0, 1.5, 2.5, 4, 6 mm ø) Soft wire cutting	6

CIRCLIP PLIERS



Circlip Pliers - Inside Straight

Drop forged from high alloy steel, hardened and tempered for strength and performance. Chequered handles for grip.

DIN 5256C

Item Number			DIN	
T3710 0	140mm (5 1/2")	8 - 13mm	J0	5
T3710 5	140mm (5 1/2")	12 - 25mm	J1	5
T3710 7	180mm (7")	19 - 60mm	J2	5
T3710 8	220mm (8 1/4")	40 - 100mm	J3	5
T3710 11	300mm (12")	85-140mm	J4	5



Circlip Pliers - Outside Straight

Drop forged from high alloy steel, hardened and tempered for strength and performance. Chequered handles for grip.

DIN 5254A

Item Number			DIN	
T3711 0	140mm (5 1/2")	3 - 10mm	A0	5
T3711 5	140mm (5 1/2")	10 - 25mm	A1	5
T3711 7	180mm (7")	19 - 60mm	A2	5
T3711 8	220mm (8 1/4")	40 - 100mm	A3	5
T3711 11	300mm (12")	85 - 140mm	A4	5



Circlip Pliers - Inside Bent

Drop forged from high alloy steel, hardened and tempered for strength and performance. Chequered handles for grip.

DIN 5256D

Item Number	Length	Ø	DIN	Box
T37125	140mm (5 1/2")	12 - 25mm	J11	5
T37127	180mm (7")	19 - 60mm	J21	5
T37128	220mm (8 1/4")	40 - 100mm	J31	5



Circlip Pliers - Outside Bent

Drop forged from high alloy steel, hardened and tempered for strength and performance. Chequered handles for grip.

DIN 5256B

Item Number	Length	Ø	DIN	Box
T37130	140mm (5 1/2")	3 - 10mm	A01	5
T37135	140mm (5 1/2")	10 - 25mm	A11	5
T37137	180mm (7")	19 - 60mm	A21	5
T37138	220mm (8 1/4")	40 - 100mm	A31	5



Circlip Pliers Set - Adjustable

Push button changeover from inside to outside configuration for convenience.

CONTENTS:

1 x adjustable circlip pliers. 1 x inside circlips, sizes: 12, 14, 16, 18, 20 & 22mm. 1 x outside circlips, sizes: 12, 14, 16, 18, 20 & 22mm.

Item Number	Box
T3716	3

RIVETING PLIERS & RIVETS



Riveting Pliers

Heavy duty steel construction for exceptional strength & durability. Colour coded interchangeable nose bushes (Nose spanner included). 3 jaw mechanism for increased grip - 50% greater gripping strength than a standard 2 jaw riveter.

Item Number	Length	Ø	Box
T3820	260mm (10 1/2")	3.15mm (1/8"), 4mm (5/32"), 4.8mm (3/16") rivets	3



Riveting Pliers Set

CONTENTS:

Riveting pliers. 25 x aluminium rivets, sizes: 1/8" (3.2mm), 5/32" (4.0mm) & 3/16" (4.8mm).

Item Number	Box
T3820AS	1

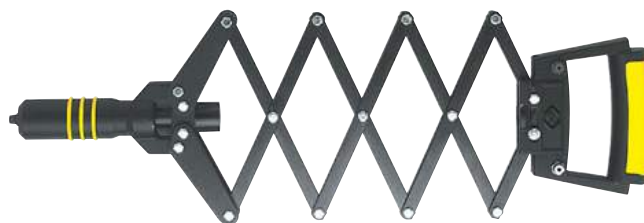

Lazy Tong Riveter



Heavy duty steel construction for exceptional strength & durability. 'Anti shock' design protects from injuries to wrist, arm or shoulder. Cushion grip handle for superior grip & comfort. Colour coded interchangeable nose bushes for convenience.

Item Number	Length	Ø	Box
T3822A	305 - 780mm (12"-32 1/2")	2.4mm (3/32"), 3.15mm (1/8"), 4mm (5/32"), 4.8mm (3/16"), 6mm (1/4") rivets	1



Rivets - Aluminium (Pack of 50)



Colour coded for simple size identification.

Item Number			
T3819A 408	3.15 x 6mm (1/8 x 1/4")	Short	15
T3819A 412	3.15 x 9mm (1/8 x 3/8")	Medium	15
T3819A 415	3.15 x 12mm (1/8 x 1/2")	Large	15
T3819A 508	4 x 6mm (5/32 x 1/4")	Short	15
T3819A 512	4 x 9mm (5/32 x 3/8")	Medium	15
T3819A 515	4 x 12mm (5/32 x 1/2")	Large	15
T3819A 612	4.8 x 9mm (3/16 x 3/8")	Medium	15
T3819A 615	4.8 x 12mm (3/16 x 1/2")	Long	15
T3819A 620	4.8 x 16mm (3/16 x 5/8")	Extra Long	15



Washers (Pack of 100)

Galvanised steel for corrosion resistance.

Item Number		
T3824 12	3.15mm (1/8")	6
T3824 15	4mm (5/32")	6
T3824 18	4.8mm (3/16")	6



Riveting Display Stand

CONTENTS:

3 x riveting pliers. 3 x riveting pliers sets. 6 x boxes of aluminium rivets (x9 sizes). 6 x boxes of washers (x3 sizes).

Item Number			
T3825LS	570 x 530 x 330mm	Stock & stand	1

PVC CUTTERS



PVC Pipe & Conduit Cutter - Ratchet

Heavy duty aluminium body - Strong & light. Ratchet action razor sharp stainless steel blade for effortless cutting of; PVC conduit, blue water mains, plastic pipe, rubber hose, pneumatic pipe, electrical sleeving, etc. Complete with special adaptor for straight or mitre cutting of small rectangular cross-section trunking.

Item Number	↔	∅	📦
430003	220mm	32mm	3



PVC Pipe & Conduit Cutter

Glass fibre reinforced polycarbonate body - Strong & light. Razor sharp stainless steel blade for efficient cutting of: PVC conduit, blue water mains, plastic pipe, rubber hose, pneumatic pipe, electrical sleeving, etc.

Item Number	↔	∅	📦
430001	195mm	28mm	3



Multi Cutter Set

Heavy duty aluminium body. Lever action razor sharp stainless steel blade for cutting; PVC conduit, plastic pipe, rubber hose, pneumatic pipe, wooden dowel, etc. 5 interchangeable anvils (flat, double radius, single radius, 90° square and mitre) allow both straight and mitred cuts.

Item Number	📦
T2240	3

PINCERS & TOP CUTTERS



Pincers

Optimised jaw design for effective gripping & extracting of screws, nails, fixings, etc. Specially profiled cutting blades for cutting metal rod & wire. High alloy steel, drop forged, hardened & tempered for exceptional strength & durability.

Item Number	↔	⊘	⊘	📦
T4108A 06	160mm (6")	2.0mm	>4.0mm	3
T4108A 07	180mm (7")	2.0mm	>4.0mm	3
T4108A 08	200mm (8")	2.0mm	>4.0mm	3



Top Cutters

High alloy steel, drop forged, hardened & tempered for strength & durability. Induction hardened jaws for outstanding long term cutting performance. Wipe clean PVC handles for added convenience. Black lacquered for corrosion protection.

Item Number	↔	⊘	⊘	⊘	📦
T3988 180	180mm (7")	2.5mm	3.2mm	>4.0mm	3
T3988 200	200mm (8")	2.8mm	3.5mm	>4.0mm	3



Top Cutters - Steel Fixer's

Special slimline design for binding & twisting wire. Induction hardened jaws for outstanding long term cutting performance. High alloy steel, drop forged, hardened & tempered for exceptional strength & durability.

Item Number	↔	⊘	📦
T4112A 08	220mm (8 1/2")	2.0mm	3
T4112A 10	250mm (10")	2.0mm	3
T4112A 11	280mm (11")	2.0mm	3

HEAVY DUTY CUTTERS



Cable & Wire Rope Cutter

Heavy duty construction, drop forged alloy steel, hardened & tempered for exceptional strength & durability. Induction hardened specially profiled shearing blades for clean cutting of a wide range of wire & cables.

Item Number	←→	⊙	⊙	📦
T3744	190mm	6mm	4mm	10



Heavy Duty Cable Shears

High-grade special tool steel cutting jaws, forged and hardened for an extended working life. Parrot-beak cutting jaws to prevent cable slippage. For large diameter copper and aluminium cables up to 27 mmØ. Not for use on steel or ACSR cable.

Item Number	⊙	📦
T3679	27mm	1



Cable Cutter - Ratchet

Heavy duty, ratchet action cutters for effortlessly cutting of large diameter cable. Hardened chrome molybdenum steel blade specially designed for cutting hard drawn copper, aluminium cable or 200 pair comms cable. Not for use on steel armoured cable.

Item Number	←→	⊙	📦
430007	190mm	32mm	3
Z3677 1	Moving blade		1
Z3677 2	Fixed blade		1



Cable Cutter - Heavy Duty Ratchet

High-grade special tool steel cutting jaws, forged and hardened for an extended working life. Heavy duty ratchet action for the effortless cutting of large diameter cable. Suitable for copper and aluminium cables up to 52 mmØ and SWA cable up to 36 mmØ.

Item Number	⊙	⊙	📦
T3678	52mm Cu/Al	36mm SWA	1
Z3678 1	Moving blade		1
Z3678 2	Fixed blade		1



Wire Cutters - Heavy Duty

Heavy duty construction, drop forged alloy steel, hardened & tempered for exceptional strength & durability. Induction hardened jaws for outstanding long term performance. Wipe clean PVC handles for added convenience.

Item Number	←→	○	📦
T3961A 08	200mm (8")	2.0mm	3
T3961A 10	250mm (10")	3.0mm	5



Bolt Cutter - Pocket

Compact cutters ideal for fencing, meshes and low tensile wire. Hot drop forged chrome vanadium steel jaws with induction hardened cutting edges for strength and durability. Compound action mechanism applies extreme cutting forces.

Item Number	←→	∅ 785Nmm ² (51TONS SQ")	∅ 1226Nmm ² (80TONS SQ")	📦
T4371A	250mm (10")	5mm	3mm	2



Bolt Cutters

High tensile, special alloy jaws heat treated for cutting hard materials up to 40HRC. Compound action mechanism applies extreme cutting forces.

Item Number	←→	∅ 785Nmm ² (51TONS SQ")	∅ 1226Nmm ² (80TONS SQ")	📦
T4358 12	340mm (13")	6mm	5mm	1
T4358 15	400mm (16")	7mm	6mm	1
T4358 18	450mm (18")	10mm	7mm	1
T4358 25	610mm (24")	11mm	9mm	1
T4358 30	800mm (31")	13mm	11mm	1
T4358 36	900mm (35")	15mm	13mm	1

PUNCH PLIERS



Revolving Punch Pliers

Specially hardened steel punches and brass anvil for long term cutting performance. 6 punch revolving head marked with size for convenience. Black lacquered coating for corrosion protection. Suitable for leather, plastic, card, etc.

Item Number	←→	i	📦
T3817	220mm (8 3/4")	2, 2.5, 3, 3.5, 4, 4.5mm	2

DEXTRO VDE

26-29

IMPACT DRIVER & BITS

44

DEXTRO VDE SLIM

30-31

MAGNETISER /
DEMAGNETIZER

44

DEXTRO

32-35

HD CLASSIC

36-39

TRITON XLS

40-43

RATCHET SCREWDRIVERS

43



SCREWDRIVERS

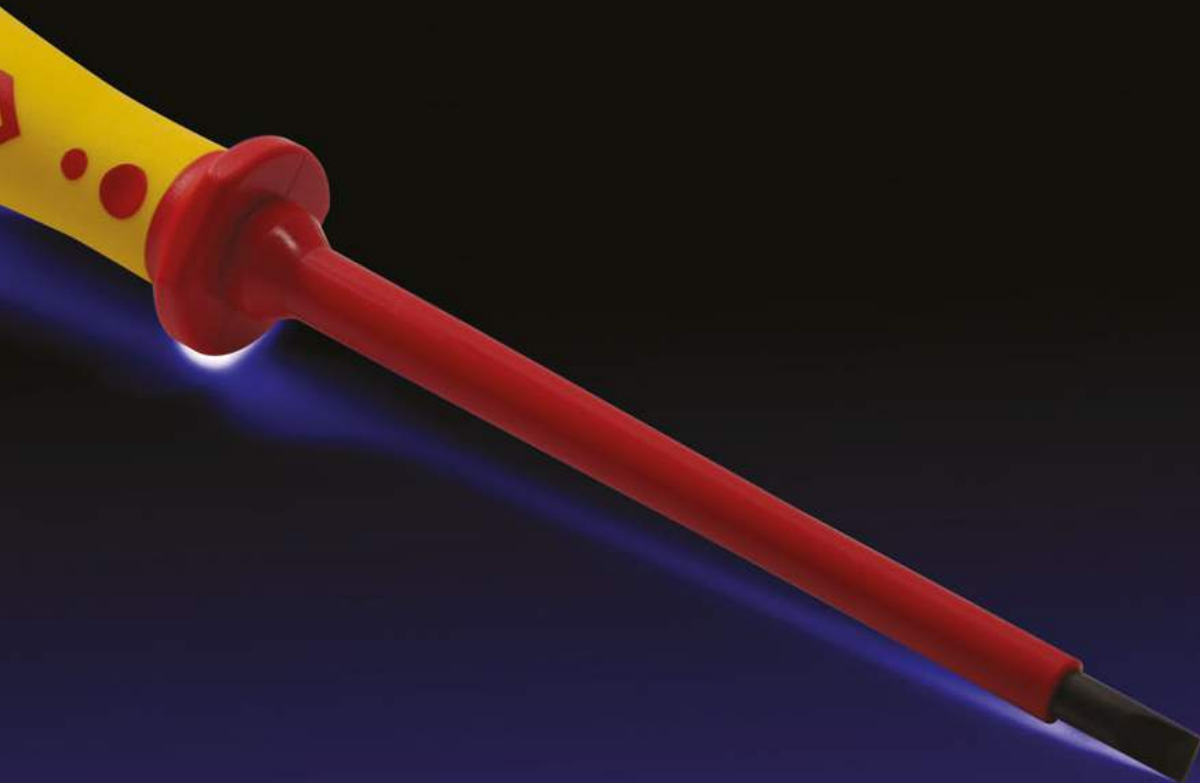

DEXTRO VDE

PREMIUM QUALITY INSULATED SCREWDRIVERS



- 1 Tip type marking for easy identification
- 2 Ergonomically shaped, dual component handle for increased comfort, control and safety
- 3 Long fine neck for precise fingertip control
- 4 Ridges along the head give extra grip in that last 1/4 turn
- 5 Handle injection moulded directly to blade giving the ultimate bond for increased reliability and durability
- 6 VDE approved - individually tested to 10,000V for safe live working up to 1,000V
- 7 Premium quality Chrome Vanadium steel blade for exceptional strength and durability
- 8 Precision machined tip for an exact screw fit and damage free screwdriving

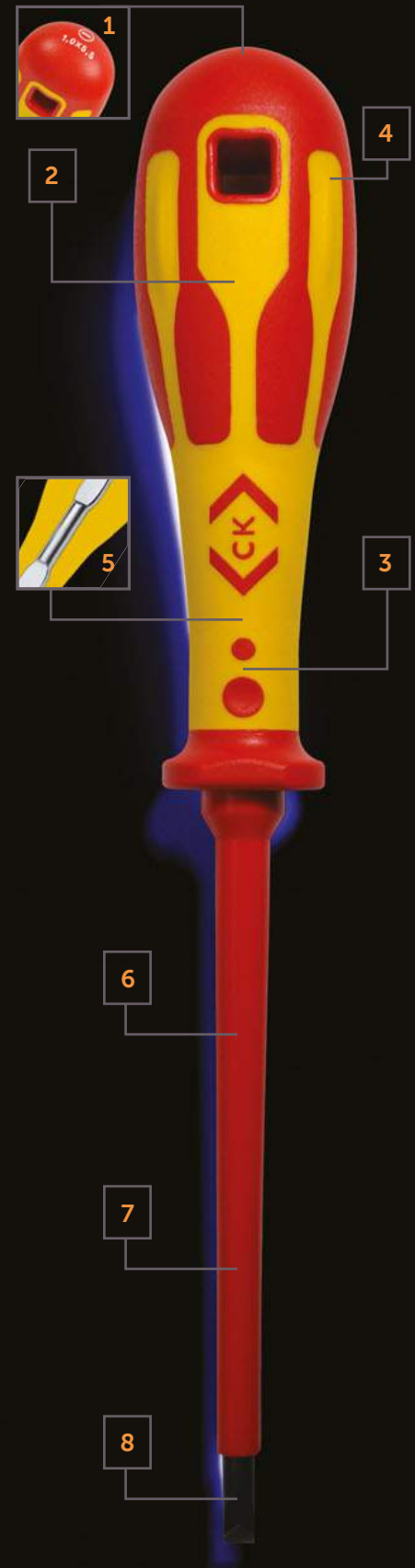

dextroTM**VDE**

Conforms to IEC 60900. Approved and independently audited by the German VDE institute.

DEXTRO VDE



VDE Screwdrivers - Slotted Parallel

EN 60900, VDE0682/201, ASTM-F 1505, ISO 2380-2

Item Number					
T49144-025	2.5mm (3/32")	75mm (3")	0.4mm (0.016")	95mm (3 3/4")	6
T49144-030	3.0mm (1/8")	100mm (4")	0.5mm (0.020")	95mm (3 3/4")	6
T49144-035	3.5mm (9/64")	100mm (4")	0.6mm (0.024")	95mm (3 3/4")	6
T49144-040	4.0mm (5/32")	100mm (4")	0.8mm (0.031")	107mm (4 7/32")	6
T49144-055	5.5mm (7/32")	125mm (5")	1.0mm (0.039")	120mm (4 3/4")	6
T49144-065	6.5mm (1/4")	150mm (6")	1.2mm (0.047")	120mm (4 3/4")	6
T49144-080	8.0mm (5/16")	175mm (7")	1.2mm (0.047")	135mm (5 5/16")	6
T49144-100	10.0mm (25/64")	200mm (8")	1.6mm (0.063")	135mm (5 5/16")	6

VDE Screwdrivers - PH

EN 60900, VDE0682/201, ASTM-F 1505, DIN ISO 8764

Item Number					
T49142-0	PH0	3.5mm (9/64")	60mm (2 3/8")	95mm (3 3/4")	6
T49142-1	PH1	5.0mm (3/16")	80mm (3 1/8")	107mm (4 7/32")	6
T49142-2	PH2	6.0mm (15/64")	100mm (4")	120mm (4 3/4")	6
T49142-3	PH3	8.0mm (5/16")	150mm (6")	135mm (5 5/16")	6



VDE Screwdrivers - Modulo

EN 60900, VDE0682/201, ASTM-F 1505

Item Number					
T49145-1	1	5.0mm (3/16")	80mm (3 1/8")	107mm (4 7/32")	6
T49145-2	2	6.0mm (15/34")	100mm (4")	120mm (4 3/4")	6



VDE Screwdrivers - PZ

EN 60900, VDE0682/201, ASTM-F 1505, DIN ISO 8764

Item Number					
T49143-0	PZ0	3.5mm (9/64")	60mm (2 3/8")	95mm (3 3/4")	6
T49143-1	PZ1	5.0mm (3/16")	80mm (3 1/8")	107mm (4 7/32")	6
T49143-2	PZ2	6.0mm (15/64")	100mm (4")	107mm (4 7/32")	6
T49143-2200	PZ2	6.0mm (15/64")	200mm (8")	120mm (4 3/4")	6
T49143-3	PZ3	8.0mm (5/16")	150mm (6")	135mm (5 5/16")	6

VDE Screwdriver Set - Modulo

CONTENTS:

1 x modulo sizes 1 x 80 & 2 x 100mm.

EN 60900, VDE0682/201, ASTM-F 1505

Item Number		
T49146	1 & 2	6



VDE Screwdriver Set - 6 Piece Slotted/PH

CONTENTS:

1 x slotted parallel sizes 2.5 x 75, 4 x 100 & 5.5 x 125mm, 1 x PH, sizes 1 x 80 & 2 x 100mm and a mainstester.

EN 60900, VDE0682/201, ASTM-F 1505, ISO 2380-2, DIN ISO 8764

Item Number	
T49182	3



VDE Screwdriver Set - 8 Piece Slotted/PH

CONTENTS:

1 x slotted parallel sizes 2.5 x 75, 4 x 100, 5.5 x 125 & 6.5 x 150mm, 1 x PH, sizes 0 x 60, 1 x 80 & 2 x 100mm and a mainstester.

EN 60900, VDE0682/201, ASTM-F 1505, ISO 2380-2, DIN ISO 8764

Item Number	
T49192	3



VDE Screwdriver Set - 6 Piece Slotted/PZ

CONTENTS:

1 x slotted parallel sizes 2.5 x 75, 4.0 x 100 & 5.5 x 125mm, 1 x PZ, sizes 1 x 80 & 2 x 100mm and a mainstester.

EN 60900, VDE0682/201, ASTM-F 1505, ISO 2380-2, DIN ISO 8764

Item Number	
T49183	3



Full Range Display - Shelf 1

CONTENTS:

12 x slotted parallel sizes 2.5 x 75, 3.0 x 100 & 4.0 x 100mm and 6 x slotted parallel sizes 3.5 x 100, 5.5 x 125, 6.5 x 150, 8.0 x 175 & 10.0 x 200mm.

Item Number		
DEXTROVDE-S1	Stock, shelf & header	1



VDE Screwdriver Set - 8 Piece Slotted/PZ

CONTENTS:

1 x slotted parallel sizes 2.5 x 75, 4.0 x 100, 5.5 x 125 & 6.5 x 150mm, 1 x PZ, sizes 0 x 60, 1 x 80 & 2 x 100mm and a mainstester.

EN 60900, VDE0682/201, ASTM-F 1505, ISO 2380-2, DIN ISO 8764

Item Number	
T49193	3

Full Range Display - Shelf 2

CONTENTS:

6 x PZ sizes 0 x 60, 1 x 80, 2 x 100, 2 x 200 & 3 x 150mm, 6 x PH sizes 0 x 60, 1 x 80, 2 x 100 & 3 x 150mm and 6 x modulo sizes 1 x 80 & 2 x 100mm.

Item Number		
DEXTROVDE-S2	Stock, shelf & header	1



Torque Screwdriver Set (1.5 to 3Nm) With VDE Blades - 3 Piece

Adjustable torque from 1.5-3.0Nm (0.1Nm increments). VDE approved blades. Precision German engineered. Quick lock mechanism for quick and easy blade interchange. Calibrated in Nm and supplied with a factory calibration certificate. Accurate to ±6%.

EN 60900, VDE0682/201, ASTM-F 1505

Item Number	i	📦
T4821	Set	1
T4821MOD1	Replacement MOD 1 blade	10
T4821MOD2	Replacement MOD 2 blade	10

Top Sellers Display

CONTENTS:

6 x slotted parallel sizes 2.5 x 75, 3 x 100, 4 x 100, 5.5 x 125 & 6.5 x 150mm, 6 x PZ sizes 0 x 60, 1 x 80, 2 x 100 & 2 x 200mm and 6 x PH sizes 1 x 80 & 2 x 100mm.

Item Number	i	📦
DEXTROVDE-TS	Stock, shelf & header	1



VDE Screwdriver - Display

CONTENTS:

4 x PH sizes 1 x 80, 2 x 100mm, PZ sizes 1 x 80, 2 x 100mm, slotted parallel sizes 2.5 x 75, 3.0 x 100, 3.5 x 100, 4.0 x 100, 5.5 x 125, 6.5 x 150mm, 2 x PH sizes 0 x 60mm, PZ sizes 0 x 60, 2 x 200mm, slotted parallel sizes 8.0 x 175mm, modulo sizes 1 x 80, 2 x 100mm, 1 x PH sizes 3 x 150mm and PZ sizes 3 x 150mm, 10.0 x 200mm.

Item Number	i	📦
CKDEXTROVDE	Stock pack	1
300001	Screwdriver stand	1
T49198H	Header card	1



VDE Interchangeable Bladed Screwdriver - 10 Piece Set

VDE Approved - individually tested to 10,000V. Soft grip handles for increased comfort. Quick lock mechanism for quick and easy blade interchange.

CONTENTS:

1 x VDE High Torque Screwdriver Handle, 1 x VDE Precision Screwdriver Handle, VDE Screwdriver Blades, Slotted:3,4,5,5 & 6.5mm, Pozi 0, 1 & 2, Modulo MOD 2 and 1 x Fabric Storage Pouch.

EN 60900, VDE0682/201, ASTM-F 1505, ISO 2380-2, DIN ISO 8764

Item Number	i	📦
T4915	Screwdriver Set	1
T4915S30	Replacement Slotted 3.0mm blade	10
T4915S40	Replacement Slotted 4.0mm blade	10
T4915S55	Replacement Slotted 5.5mm blade	10
T4915S65	Replacement Slotted 6.5mm blade	10
T4915PZ0	Replacement Pozi 0 blade	10
T4915PZ1	Replacement Pozi 1 blade	10
T4915PZ2	Replacement Pozi 2 blade	10
T4915M2	Replacement Modulo 2 blade	10

DEXTRO VDE SLIM

PREMIUM QUALITY INSULATED SCREWDRIVERS



The C.K dextroVDE Slim Screwdrivers provide easy access to recessed screws. Eliminating the need to remove insulation and compromise safety, they are slim enough to fit into the tightest of spaces yet still offer outstanding torsional strength and feature active torque feedback for an extended working life.

- 1 Slim shafted insulated blades - allow access to recessed screws and fixings
- 2 VDE approved - individually tested to 10,000V for safe working up to 1,000V
- 3 100% German manufactured - quality and performance assured
- 4 Dual component, ergonomic handle - specifically designed for use by electricians
- 5 Premium quality chrome vanadium steel blades - for exceptional strength and durability



Conforms to IEC 60900. Approved and independently audited by the German VDE institute.



DEXTRO VDE SLIM



VDE Slim Screwdrivers - PZ

EN 60900, VDE0682/201, ASTM-F 1505, DIN ISO 8764

Item Number					
T49242-1	PZ1	5.0mm (3/16")	100mm (4")	95mm (3 3/4")	6
T49242-2	PZ2	6.0mm (15/64")	125mm (5")	107mm (4 7/32")	6



VDE Slim Screwdrivers - PH

EN 60900, VDE0682/201, ASTM-F 1505, DIN ISO 8764

Item Number					
T49243-1	PH1	5.0mm (3/16")	100mm (4")	95mm (3 3/4")	6
T49243-2	PH2	8.0mm (5/16")	125mm (5")	107mm (4 7/32")	6



VDE Slim Screwdrivers - Slotted

EN 60900, VDE0682/201, ASTM-F 1505, ISO 2380-2

Item Number								
T49244-035	3.5mm (9/64")	100mm (4")	0.6mm (0.024")	95mm (3 3/4")	6			
T49244-040	4.0mm (5/32")	100mm (4")	0.8mm (0.031")	95mm (3 3/4")	6			
T49244-055	5.5mm (7/32")	125mm (5")	1.0mm (0.039")	107mm (4 7/32")	6			



VDE Slim Screwdrivers - Modulo

Item Number					
T49245-2	MOD2	6.0mm (15/34")	125mm (5")	107mm (4 7/32")	6



VDE Slim Screwdriver Set - 5 Piece Slotted/PZD

CONTENTS:

1 x slotted parallel sizes 3.5 x 100, 4.0 x 100 & 5.5 x 125mm, 1 x PZ, sizes 1 x 100 & 2 x 125mm.

EN 60900, VDE0682/201, ASTM-F 1505, ISO 2380-2, DIN ISO 8764

Item Number	
T49283	6



VDE Slim Screwdriver - Stand

CONTENTS:

4 x slotted sizes 3.5 x 100mm, 4.0 x 100mm, 3 x slotted size 5.5 x 125mm, 4 x PZ sizes 1 x 100, 2 x 125, 3 x PH sizes 1 x 100, 2 x 125, and 3 x modulo size 2 x 125mm.

Item Number		
CKDEXTRVDES LIM	Stock pack	1
300003	Screwdriver stand	1
T49298H	Header card	1

DEXTRO

PREMIUM QUALITY SCREWDRIVERS



- 1 Tip type marking for easy identification
- 2 Ergonomically shaped, dual component handle for increased comfort, control and safety
- 3 Long fine neck for precise fingertip control
- 4 Ridges along the head give extra grip in that last 1/4 turn
- 5 Handle injection moulded directly to blade giving the ultimate bond for increased reliability and durability
- 6 Premium quality chrome vanadium steel blade for exceptional strength and durability
- 7 Precision machined tip for an exact screw fit and damage free screwdriving



dextro™

DEXTRO



Screwdrivers - Slotted Parallel

ISO 2380-2

Item Number					
T49125-025	3.0mm (1/8")	75mm (3")	0.4mm (0.061")	95mm (3 3/4")	6
T49125-030	3.0mm (1/8")	75mm (3")	0.5mm (0.020")	95mm (3 3/4")	6
T49125-03025	3.0mm (1/8")	250mm (10")	0.5mm (0.020")	95mm (3 3/4")	6
T49125-035	3.5mm (9/64")	100mm (4")	0.6mm (0.024")	95mm (3 3/4")	6
T49125-040	4.0mm (5/32")	125mm (5")	0.8mm (0.031")	107mm (4 7/32")	6
T49125-055	5.5mm (7/32")	150mm (6")	1.0mm (0.039")	120mm (4 3/4")	6

Screwdrivers - PZ

ISO 8764

Item Number					
T49113-0	PZ0	3.5mm (9/64")	60mm (23/8")	95mm (3 3/4")	6
T49113-1	PZ1	5.0mm (3/16")	75mm (3")	107mm (4 7/32")	6
T49113-1250	PZ1	5.0mm (3/16")	250mm (10")	107mm (4 7/32")	6
T49113-2	PZ2	6.0mm (15/64")	150mm (6")	120mm (4 3/4")	6
T49113-2250	PZ2	6.0mm (15/64")	250mm (10")	120mm (4 3/4")	6
T49113-3	PZ3	8.0mm (5/16")	150mm (6")	135mm (5 5/16")	6

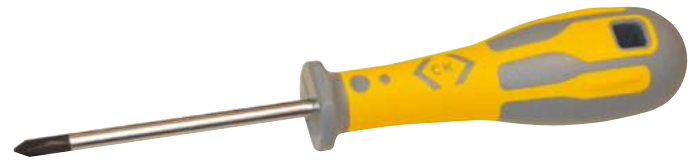

Screwdrivers - Slotted Flared

ISO 2380-2

Item Number					
T49110-040	4.0mm (5/32")	75mm (3")	0.8mm (0.031")	107mm (4 7/32")	6
T49110-055	5.5mm (7/32")	100mm (4")	1.0mm (0.039")	120mm (4 3/4")	6
T49110-065	6.5mm (1/4")	150mm (6")	1.2mm (0.047")	120mm (4 3/4")	6
T49110-100	10.0mm (25/64")	200mm (8")	1.6mm (0.063")	135mm (5 5/16")	6

Screwdrivers - PH

ISO 8764

Item Number					
T49112-0	PH0	3.5mm (9/64")	60mm (2 3/8")	95mm (3 3/4")	6
T49112-1	PH0	5.0mm (3/16")	80mm (3 1/8")	107mm (4 7/32")	6
T49112-1250	PH1	5.0mm (3/16")	250mm (10")	107mm (4 7/32")	6
T49112-2	PH2	6.0mm (15/64")	100mm (4")	120mm (4 3/4")	6
T49112-2250	PH2	6.0mm (15/64")	250mm (10")	120mm (4 3/4")	6
T49112-3	PH3	8.0mm (5/16")	150mm (6")	135mm (5 5/16")	6



Screwdrivers - TX

Item Number					
T49117-06	T 06	3.0mm (1/8")	70mm (2 3/4")	95mm (3 3/4")	6
T49117-07	T 07	3.0mm (1/8")	70mm (2 3/4")	95mm (3 3/4")	6
T49117-08	T 08	3.0mm (1/8")	70mm (2 3/4")	95mm (3 3/4")	6
T49117-09	T 09	3.0mm (1/8")	70mm (2 3/4")	95mm (3 3/4")	6
T49117-10	T 10	3.0mm (1/8")	80mm (3 1/8")	107mm (4 7/32")	6
T49117-15	T 15	3.5mm (9/64")	80mm (3 1/8")	107mm (4 7/32")	6
T49117-20	T 20	4.0mm (5/32")	90mm (3 1/2")	107mm (4 7/32")	6
T49117-25	T 25	4.5mm (11/64")	90mm (3 1/2")	107mm (4 7/32")	6
T49117-27	T 27	5.5mm (7/32")	110mm (4 1/4")	120mm (4 3/4")	6
T49117-30	T 30	6.0mm (15/64")	110mm (4 1/4")	120mm (4 3/4")	6
T49117-40	T 40	7.0mm (9/32")	120mm (4 3/4")	135mm (5 5/16")	6



Screwdrivers - Robertson

Item Number					
T49118-1	Size 1	6.0mm (15/64")	125mm (5")	120mm (4 3/4")	6
T49118-2	Size 2	6.0mm (15/64")	125mm (5")	120mm (4 3/4")	6
T49118-3	Size 3	6.0mm (15/64")	125mm (5")	120mm (4 3/4")	6



Screwdriver Set - 5 Piece Slotted/PZ

CONTENTS:

1 x slotted flared sizes 4.0 x 75, 5.5 x 100 & 6.5 x 150mm and 1 x PZ sizes 1 x 80 & 2 x 100mm.

ISO 2380-2, DIN ISO 8764

Item Number	
T49153	3



Screwdriver Set - 7 Piece Slotted/PH

CONTENTS:

1 x slotted flared sizes 4.0 x 75, 5.5 x 100 & 6.5 x 150mm, 1 x slotted parallel size 3.0 x 75mm and 1 x PH sizes 0 x 60, 1 x 80 & 2 x 100mm.

ISO 2380-2, DIN ISO 8764

Item Number	
T49162	3



Screwdriver Set - 7 Piece Slotted/PZ

CONTENTS:

1 x slotted flared sizes 4.0 x 75, 5.5 x 100 & 6.5 x 150mm, 1 x slotted parallel size 3.0 x 75mm and 1 x PZ sizes 0 x 60, 1 x 80 & 2 x 100mm.

ISO 2380-2, DIN ISO 8764

Item Number	
T49163	3



Full Range Display - Shelf 1

CONTENTS:

6 x slotted flared, sizes: 4.0 x 75, 5.5 x 100, 6.5 x 150 & 10.0 x 200mm,
6 x slotted parallel, sizes: 2.5 x 75, 3.0 x 75, 3.0 x 250, 3.5 x 100,
4.0 x 125 & 5.5 x 150mm and 6 x PH, size: 0 x 60mm.

Item Number	
DEXTRO-S1	1



Top Sellers Display

CONTENTS:

6 x slotted flared sizes 5.5 x 100, 6.5 x 150 & 10.0 x 200mm,
6 x slotted parallel sizes 3.0 x 75 & 4.0 x 125mm, 6 x PZ, sizes 0 x 60,
1 x 80, 2 x 100 & 2 x 250mm and 6 x PH sizes 1 x 80 & 2 x 100mm.

Item Number	
DEXTRO-TS	1



Full Range Display - Shelf 2

CONTENTS:

6 x PZ sizes 0 x 60, 1 x 80, 1 x 250, 2 x 100, 2 x 250 & 3 x 150mm
and 6 x PH sizes 1 x 80, 1 x 250, 2 x 100, 2 x 250 & 3 x 150mm.

Item Number	
DEXTRO-S2	1



Full Range Display - Shelf 3

CONTENTS:

6 x TX sizes 6 x 70, 7 x 70, 8 x 70, 9 x 70, 10 x 80, 15 x 80, 20 x 90,
25 x 90, 27 x 110, 30 x 110 & 40 x 120mm.

Item Number	
DEXTRO-S3	1





HD CLASSIC

CLASSIC HEAVY DUTY SCREWDRIVERS

- 1 Shatter resistant acetate handle
- wipe clean, oil and acid resistant
- 2 Large square shape handle design
for maximum torque
- 3 Handle injection moulded directly
to blade giving the ultimate bond for
increased reliability and durability
- 4 Anti roll flats to prevent the screwdriver
rolling off sloping surfaces
- 5 Chrome plated toughened alloy steel
blade for increased strength and durability
- 6 Precision machined tip for an exact screw
fit and damage free screwdriving



HDclassic

HD CLASSIC



Screwdrivers - Slotted Parallel

ISO 2380-2

Item Number					
T4965 03	3mm (1/8")	75mm (3")	0.5mm (0.02")	70mm (2 3/4")	6
T4975 06	3mm (1/8")	150mm (6")	0.5mm (0.02")	80mm (3 1/8")	6
T4975 08	3mm (1/8")	200mm (8")	0.5mm (0.02")	80mm (3 1/8")	6
T4965 04	4mm (5/32")	100mm (4")	0.8mm (0.03")	80mm (3 1/8")	6
T4975 10	4mm (5/32")	250mm (10")	0.8mm (0.03")	80mm (3 1/8")	6
T4965 05	4.5mm (11/64")	125mm (5")	0.8mm (0.03")	80mm (3 1/8")	6
T4965 06	5mm (3/16")	150mm (6")	0.8mm (0.03")	90mm (3 1/2")	6
T4965 08	6mm (15/64")	300mm (12")	0.8mm (0.03")	90mm (3 1/2")	6
T4965 12	6mm (15/64")	300mm (12")	0.8mm (0.03")	90mm (3 1/2")	6



Screwdrivers - Slotted Flared

ISO 2380-2

Item Number					
T4810 03	5mm (3/16")	75mm (3")	0.8mm (0.03")	90mm (3 1/2")	6
T4810 04	6mm (15/64")	100mm (4")	1.0mm (0.04")	100mm (4")	6
T4810 05	7mm (9/32")	125mm (5")	1.0mm (0.04")	100mm (4")	6
T4810 06	8mm (5/16")	150mm (6")	1.2mm (0.05")	110mm (4 1/4")	6
T4810 08	9mm (11/32")	200mm (8")	1.2mm (0.05")	120mm (4 3/4")	6
T4810 10	10mm (3/8")	250mm (10")	1.6mm (0.06")	130mm (5 1/8")	6
T4810 12	12mm (1/2")	300mm (12")	2.0mm (0.08")	130mm (5 1/8")	6



Screwdrivers - Slotted Strike Through

Strike through design for the most demanding applications.

Item Number					
T4811 04	6mm (15/64")	100mm (4")	1.0mm (0.04")	100mm (4")	6
T4811 06	8mm (5/16")	150mm (6")	1.2mm (0.05")	110mm (4 1/4")	6
T4811 08	10mm (3/8")	200mm (8")	1.6mm (0.06")	120mm (4 3/4")	6
T4811 10	13mm (1/2")	250mm (10")	2.0mm (0.08")	130mm (5 1/8")	6



Screwdrivers - PH

DIN ISO 8764

Item Number					
T4812 0	PH0	3.5mm (9/64")	65mm (2 1/2")	70mm (2 3/4")	6
T4812 1	PH1	5mm (3/16")	80mm (3 1/8")	90mm (3 1/2")	6
T4977 1	PH1	5mm (3/16")	250mm (10")	100mm (4")	6
T4812 2	PH2	6mm (15/64")	100mm (4")	100mm (4")	6
T4977 2	PH2	6mm (15/64")	250mm (10")	110mm (4 1/4")	6
T4812 3	PH3	8mm (5/16")	150mm (6")	110mm (4 1/4")	6
T4812 4	PH4	10mm (3/8")	200mm (8")	120mm (4 3/4")	6



Screwdrivers - PZ

DIN ISO 8764

Item Number					
T4813 0	PZ0	3.5mm (9/64")	60mm (2 1/2")	70mm (2 3/4")	6
T4813 1	PZ1	5mm (3/16")	80mm (1/8")	90mm (3 1/2")	6
T4987 1	PZ1	5mm (3/16")	250mm (10")	100mm (4")	6
T4813 2	PZ2	6mm (15/64")	100mm (4")	100mm (4")	6
T4987 2	PZ2	6mm (15/64")	250mm (10")	110mm (4 1/4")	6
T4813 3	PZ3	8mm (5/16")	150mm (6")	110mm (4 1/4")	6
T4813 4	PZ4	10mm (3/8")	200mm (8")	120mm (4 3/4")	6



Screwdrivers - PZ Stubby

DIN ISO 8764

Item Number					
T4816 1	PZ1	5mm (3/16")	25mm (1")	60mm (2 3/8")	6
T4816 2	PZ2	6mm (15/64")	25mm (1")	60mm (2 3/8")	6



Screwdrivers - Slotted Stubby

ISO 2380-2

Item Number					
T4814 25	6.5mm (1/4")	25mm (1")	1.2mm (0.05")	60mm (2 3/8")	6
T4814 31	8mm (5/16")	25mm (1")	1.2mm (0.05")	60mm (2 3/8")	6



Screwdrivers - PH Stubby

DIN ISO 8764

Item Number					
T4815 1	PH1	5mm (3/16")	25mm (1")	60mm (2 3/8")	6
T4815 2	PH2	6mm (15/64")	25mm (1")	60mm (2 3/8")	6



Nut Spinners

Extra deep socket for reaching nuts through which bolts protrude.

DIN 3125

Item Number				
T4334M 03	3mm	130mm (5 1/8")	90mm (3 1/2")	6
T4334M 035	3.5mm	130mm (5 1/8")	90mm (3 1/2")	6
T4334M 04	4mm	130mm (5 1/8")	90mm (3 1/2")	6
T4334M 045	4.5mm	130mm (5 1/8")	90mm (3 1/2")	6
T4334M 05	5mm	130mm (5 1/8")	90mm (3 1/2")	6
T4334M 055	5.5mm	130mm (5 1/8")	90mm (3 1/2")	6
T4334M 06	6mm	130mm (5 1/8")	90mm (3 1/2")	6
T4334M 07	7mm	130mm (5 1/8")	100mm (4")	6
T4334M 08	8mm	130mm (5 1/8")	100mm (4")	6
T4334M 09	9mm	130mm (5 1/8")	100mm (4")	6
T4334M 10	10mm	130mm (5 1/8")	100mm (4")	6
T4334M 11	11mm	120mm (4 3/4")	110mm (4 1/4")	6
T4334M 12	12mm	120mm (4 3/4")	110mm (4 1/4")	6
T4334M 13	13mm	120mm (4 3/4")	110mm (4 1/4")	6



Screwdriver Set - 8 Piece Slotted/PZ

CONTENTS:

1 x slotted flared sizes 6.0 x 100, 6.5 x 25, 7.0 x 125 & 8.0 x 100mm,
1 x slotted parallel sizes 3.0 x 75 & 4.0 x 100mm and 1 x PZ sizes
1 x 80 & 2 x 100mm.

Item Number		
T4999B		3



Full Range Display - Shelf 1

CONTENTS:

6 x slotted parallel sizes 3.0 x 150, 3.0 x 200, 4.0 x 250 & 6.0 x 300mm
and 6 x slotted flared sizes 5.0 x 75, 6.0 x 100, 7.0 x 125, 8.0 x 150,
9.0 x 200, 10.0 x 250 & 12.0 x 300mm.

Item Number		
HDCLASSIC-S1	Stock, shelf & header card	1

Full Range Display - Shelf 2

CONTENTS:

12 x slotted parallel sizes 3.0 x 75 & 4.0 x 100mm, 6 x slotted parallel
sizes 4.5 x 125, 5.0 x 150 & 5.0 x 200mm and 6 x slotted strike-through
sizes 6.0 x 100, 8.0 x 150, 10.0 x 200 & 13.0 x 250mm.

Item Number		
HDCLASSIC-S2	Stock, shelf & header card	1

Full Range Display - Shelf 3

CONTENTS:

12 x PZ, size 2 x 100mm, 6 x PZ sizes 0 x 60, 1 x 80, 2 x 100, 3 x 150
& 4 x 200mm and 6 x PH sizes 0 x 65, 1 x 80, 2 x 100, 3 x 150 &
4 x 200mm.

Item Number		
HDCLASSIC-S3	Stock, shelf & header card	1

Full Range Display - Shelf 4

CONTENTS:

12 x slotted flared sizes 6.5 x 25mm,
6 x slotted flared sizes 8.0 x 25mm, 6 x PZ sizes 1 x 25, 2 x 25, 1 x 250
& 2 x 250mm, 6 x PH sizes 1 x 25, 2 x 25, 1 x 250 & 2 x 250mm.

Item Number		
HDCLASSIC-S4	Stock, shelf & header card	1



Top Sellers Display

CONTENTS:

6 x slotted flared sizes 6.5 x 25, 6.0 x 100 & 8.0 x 150mm, 6 x slotted
parallel sizes 3.0 x 75 & 4.0 x 100mm, 6 x PZ sizes 0 x 60, 1 x 80,
2 x 25 & 2 x 100mm and 6 x PH sizes 1 x 80 & 2 x 100mm.

Item Number		
HDCLASSIC-TS	Stock, shelf & header card	1

TRITON XLS

PROFESSIONAL GENERAL PURPOSE SCREWDRIVERS



- 1 Tip type marking for easy identification
- 2 Large soft grip tri-lobe handle for exceptional comfort and high torque turns
- 3 Handle injection moulded directly to blade giving the ultimate bond for increased reliability and durability
- 4 Anti roll flats to prevent the screwdriver rolling off sloping surfaces
- 5 Chrome plated, toughened alloy steel blade for increased strength and durability
- 6 Magnetic tip holds the screw securely to the tip to aid positioning and setting



TRITON XLS



Screwdrivers - Slotted Parallel

ISO 2380-2

Item Number					
T4725-030	3.0mm (1/8")	75mm (3")	0.6mm (0.024")	89mm (3 3/8")	6
T4725-040	4.0mm (5/32")	100mm (4")	0.8mm (0.031")	100mm (4")	6
T4725-055	5.5mm (7/32")	250mm (10")	1.0mm (0.039")	100mm (4")	6



Screwdrivers - Slotted Flared

ISO 2380-2

Item Number					
T4720-055	5.5mm (7/32")	100mm (4")	1.0mm (0.039")	100mm (4")	6
T4720-065	6.5mm (1/4")	150mm (6")	1.2mm (0.047")	108mm (4 1/4")	6
T4720-100	10mm (25/64")	200mm (8")	1.6mm (0.063")	118mm (4 5/8")	6



Screwdrivers - PH

DIN ISO 8764

Item Number					
T4722-0	PH0	3.0mm (1/8")	60mm (2 3/8")	89mm (3 3/8")	6
T4722-1	PH1	5.0mm (3/16")	75mm (3")	100mm (4")	6
T4722-1250	PH1	5.0mm (3/16")	250mm (10")	100mm (4")	6
T4722-2250	PH2	6.0mm (15/64")	250mm (10")	108mm (4 1/4")	6
T4722-2	PH2	6.0mm (15/64")	100mm (4")	108mm (4 1/4")	6
T4722-3	PH3	8.0mm (5/16")	150mm (6")	118mm (4 5/8")	6



Screwdrivers - PZ

DIN ISO 8764

Item Number					
T4723-0	PZ0	3.0mm (1/8")	60mm (2 3/8")	89mm (3 3/8")	6
T4723-1	PZ1	5.0mm (3/16")	75mm (3")	100mm (4")	6
T4723-1250	PZ1	5.0mm (3/16")	250mm (10")	100mm (4")	6
T4723-2	PZ2	6.0mm (15/64")	100mm (4")	108mm (4 1/4")	6
T4723-2250	PZ2	6.0mm (15/64")	250mm (10")	108mm (4 1/4")	6
T4723-3	PZ3	8.0mm (5/16")	150mm (6")	118mm (4 5/8")	6



Screwdriver Set - 5 Piece Slotted/PH

CONTENTS:

1 x slotted flared sizes 5.5 x 100 & 6.5 x 150mm, 1 x slotted parallel size 4.0 x 100mm and 1 x PH sizes 1 x 75 & 2 x 100mm.

ISO 2380-2, DIN ISO 8764

Item Number	
T4726	6



Screwdriver Set - 5 Piece Slotted/PZD

CONTENTS:
 1 x slotted flared sizes 5.5 x 100 & 6.5 x 150mm, 1 x slotted parallel size 4.0 x 100mm and 1 x PZ sizes 1 x 75 & 2 x 100mm.
 ISO 2380-2, DIN ISO 8764

Item Number	
T4727	6



Screwdriver Set - Insulated 5 Piece Slotted/PH

CONTENTS:
 1 x slotted parallel sizes 2.5 x 75, 4.0 x 100 & 5.5 x 125mm and 1 x PH sizes 1 x 80 & 2 x 100mm.
 EN 60900, ISO 2380-2, DIN ISO 8764

Item Number	
T4728	6



Screwdriver Set - Insulated 5 Piece Slotted/PZD

CONTENTS:
 1 x slotted parallel sizes 2.5 x 75, 4.0 x 100 & 5.5 x 125mm and 1 x PZ sizes 1 x 80 & 2 x 100mm.
 EN 60900, ISO 2380-2, DIN ISO 8764

Item Number	
T4729	6



Screwdriver Set - Insulated Slotted/PZD Counterbox of 10

CONTENTS:
 10 x Triton XLS screwdriver sets - 1000v insulated 5 piece slotted/PZ.

Item Number	
T4729CBOX	1



Full Range Display - Shelf 1

CONTENTS:
 6 x slotted flared sizes 5.5 x 100, 6 x 200 & 6.5 x 150mm, 12 x slotted parallel size 4.0 x 100mm, 6 x slotted parallel sizes 3.0 x 75 & 5.5 x 250mm, 6 x PZ sizes 1 x 250 & 2 x 250mm and 6 x PH sizes 1 x 250 & 2 x 250mm.

Item Number	
TRITONXLS-S1	1

Full Range Display - Shelf 2

CONTENTS:
 12 x PZ sizes 1 x 75 & 2 x 100mm, 6 x PZ sizes 0 x 60 & 3 x 150mm, 12 x PH size 2 x 100mm and 6 x PH sizes 0 x 60, 1 x 75 & 3 x 150mm.

Item Number	
TRITONXLS-S2	1



Top Sellers Display

CONTENTS:

6 x slotted flared sizes 5.5 x 100, 6.5 x 150 & 10.0 x 200mm,
6 x slotted parallel sizes 3.0 x 75 & 4.0 x 100mm, 6 x PZ sizes 0 x 60,
1 x 75, 2 x 100 & 2 x 250mm and 6 x PH, sizes: 1 x 75 & 2 x 100mm.

Item Number	
TRITONXLS-TS	1



Flexible Shafted Screwdriver

Strong yet flexible shaft for access to screws and fixings in awkward places. Magnetic bit holder for positive bit retention. For use with 6mm - 1/4" hexagon screwdriver bits (not included).

Item Number				
T4760	200mm	110mm	6mm	6



Flexible Shafted Screwdriver Counterbox of 9

CONTENTS:

9 x flexible shafted screwdrivers.

Item Number	
T4760CBOX	1

RATCHET SCREWDRIVERS



Ratchet Screwdriver Bit & Socket Set

Hi-torque ratchet mechanism for durability. Left & right hand rotation plus lock action for convenience. Magnetic shaft for secure bit retention. Cushion grip handle with convenient internal bits storage compartment.

CONTENTS:

Ratchet driver, 1/4" square drive adapter, Screwdriver bits:
1 x slotted sizes 3.0, 4.0, 4.5, 5.0, 6.0, 7.0, 8.0 & 9.0mm, 1 x PH sizes 0, 1, 2 & 3, 1 x PZ sizes 0, 1, 2 & 3, 1 x hexagon sizes 1.5, 2.0, 2.5, 3.0, 4.0, 5.0, 5.5 & 6.0mm and 1 x TX tamperproof sizes 8, 10, 15, 20, 25, 27, 30 & 40 and Sockets: 1 x metric, sizes 6, 7, 8, 10, 11 & 13mm, 1 x imperial, sizes 3/16, 1/4, 5/16, 11/32, 3/8 & 7/16".

Item Number	
T4826D	3



Ratchet Screwdriver & Bits Set

Hi-torque ratchet mechanism for durability. Left & right hand rotation plus lock action for convenience. Magnetic shaft for secure bit retention. Cushion grip handle with convenient internal bits storage compartment.

CONTENTS:

Ratchet screwdriver, Screwdriver bits: 1 x slotted sizes 3.0, 4.7 & 6.3mm, 1 x PH size 2, 1 x PZ sizes 1, 2 & 3 and 1 x hexagon sizes 3, 4 & 5mm.

Item Number	
T4829D	3

IMPACT DRIVER BITS



Impact Driver Set

Heavy duty steel body - strong and durable. Chrome plated for corrosion protection. Shock absorbing grip for comfort & protection. Twist to reverse function for convenience. High strength chrome vanadium bits. Steel case for convenient storage.

CONTENTS:

Impact driver, 1/2" to 1/4" drive adapter, Screwdriver bits: 1 x slotted sizes 8 & 10mm and 1 x PH sizes 2 & 3.

Item Number		
T4928	6 piece set	2

Impact Driver Bits

Replacement chrome vanadium impact driver bit.

Item Number		
T4928 362	Spare Bit PH2 x 36mm	1
T4928 803	Spare Bit PH3 x 80mm	1
T4928 802	Spare Bit PH2 x 80mm	1
T4928 36P3	Spare Bit PZ3 x 36mm	1
T4928 36P2	Spare Bit PZ2 x 36mm	1
T4928 36M12	Spare Bit 12 x 36mm	1
T4928 36M10	Spare Bit 10 x 36mm	1
T4928 36M08	Spare Bit 8 x 36mm	1
T4928 363	Spare Bit PH3 x 36mm	1

MAGNETISER / DEMAGNETIZER



Magnetiser / Demagnetiser

For the fast and effective magnetising or demagnetising of screwdrivers, tweezers etc.

Item Number		
T1350	90g	3

The dextro[™]VDE range from**NOW UP TO
30%
TOUGHER!*****NOW 30%
TOUGHER!**

C.K. dextro screwdrivers have always exceeded the tip strength requirements of ISO 8764-1:2004, the international standard for screwdrivers¹.

However, through an extensive design optimisation programme undertaken by our engineers and metallurgists, C.K. dextroVDE screwdrivers are now tougher than ever before... **up to 30% tougher in fact.**

*vs original dextro screwdriver ¹ISO 8764-1:2004 refers to recessed head screwdrivers ²Applies to PZ2 screwdriver.

**designed
for professionals**www.ck-tools.com

See pages 26-31

CABLE RODS

48-51

SWITCH KEYS

58-59

DRAW TAPES

51-52

CONDUIT BUSH WRENCHES

60

CABLE & WIRE
STRIPPING TOOLS

53-54

SOLDERING IRONS
& ACCESSORIES

60

CABLE CUTTING

55-56

PUNCH DOWN TOOLS

60

CABLE TIE GUNS

56

RE-THREADING TOOLS

60

MAINSTESTERS

57

TOOL KITS

61-63

VOLTAGE DETECTORS

58

SERVICE CASES

63



ELECTRICIAN'S TOOLS





MIGHTYRODS PRO

NEXT GEN ADVANCED TECHNOLOGY

MightyRods PRO cable rods encompass a fusion of advanced technological features that deliver the ultimate in cable rod performance.

Improving on the job efficiency, MightyRods PRO cable rods get the job done.



100% SPLINTER PROOF RODS

SplinterSHIELD is an advancement in cable rod technology. The durable SplinterSHIELD coating fully encases the inner fiberglass rod to prevent harmful splintering



UNSURPASSED STRENGTH

Through the use of an innovative triple fixing system, the super tough zinc-plated steel Mighty-Fix connectors offer unsurpassed tensile strength in excess of 275kg. Furthermore, the ultra-slim profile reduces snagging and provides accessibility through smaller holes.



MIGHTYRODS

PRO

CABLE RODS



MightyRods PRO 12m Super Cable Rod Set

The most advanced collection of MightyRods and accessories, cable rod kits don't come any better than this. The 12m Super Set features 100% splinter-proof rods, 4 rod flexibilities and 10 time saving accessories, a glow in the dark phosphorescent GLO rod, a super flexible Spira-FLEX rod and super tough 'MIGHTY-FIX' zinc plated steel connectors.

CONTENTS:

2 x 1m MightyRods PRO 7mmØ Rods (Rigid), 8 x 1m MightyRods PRO 6mmØ Rods (Flexible), 1 x 1m MightyRods PRO 4mmØ Spira-FLEX Rod (Super-Flexible), 1 x 1m MightyRods PRO 6mmØ GLO Rod (Flexible), Flexi Lead (Mini-Flex), Ring, Hook, Gender Changer, Flat Bullet, Domed Bullet, In-line Swivel, Torch, Magnet and Chain.

Item Number		
T5422	12 x 1m	1



MightyRods PRO 10m Standard Cable Rod Set

A wide range of rods and accessories for both domestic and commercial installations, this kit is set to become the best seller. Featuring 10 meters of 100% splinter-proof rods, 4 rod flexibilities, 7 time saving accessories, a super flexible Spira-FLEX rod and super tough 'MIGHTY-FIX' zinc plated steel connectors.

CONTENTS:

2 x 1m MightyRods PRO 7mmØ Rods (Rigid), 7 x 1m MightyRods PRO 6mmØ Rods (Flexible), 1 x 1m MightyRods PRO 4mmØ Spira-FLEX Rod (Super-Flexible), Flexi Lead (Mini-Flex), Ring, Hook, Gender Changer, Flat Bullet, Domed Bullet and an In-line Swivel.

Item Number		
T5421	10 x 1m	1



MightyRods PRO 5m Starter Cable Rod Set

Want to try out the next generation MightyRods PRO cable rods or add to your existing MightyRods set, then this is the kit to go for. Featuring 5 meters of 100% splinter-proof rods, 2 rod flexibilities, 3 time saving accessories and super tough 'MIGHTY-FIX' zinc plated steel connectors.

CONTENTS:

5 x 1m MightyRods PRO 6mmØ Rods (Flexible), Flexi Lead (Mini-Flex), Ring and Hook.

Item Number		
T5420	5 x 1m	1



MightyRods PRO Cable Rods 6mm Pk2

A pair of flexible 6mmØ rods ideal for most common routing needs.

Item Number	Ø	i	
T5430	6mm	Flexible	1



MightyRods PRO Cable Rods 7mm Pk2

A pair of more rigid 7mmØ rods ideal for overhead runs. They also provide greater control during straight cable runs.

Item Number	Ø	i	
T5431	7mm	Rigid	1



MightyRods PRO GLO Cable Rod 6mm Pk1

A flexible 6mmØ rod, this phosphorescent GLO rod guides the way when routing in low light conditions.

Item Number	Ø	i	i	📦
T5432	6mm	Flexible	Phosphorescent	1



MightyRods PRO SpiraFLEX Cable Rod 4mm Pk1

This super flexible 4mm Ø rod is the perfect solution when access is tight or when navigating around obstacles. The innovative helical profile and PET material reduces friction and minimises snagging.

Item Number	Ø	i	📦
T5433	4mm	Super-flexible	1



MightyRods 7pc Standard Kit Accessory Pack

A full range of accessories from the MightyRods PRO Standard Kit.

CONTENTS:
Flexi Lead, Hook, Ring, Gender Changer, Flat Bullet, In-line Swivel and Domed Bullet.

Item Number	i	📦
T5440	7 piece	1

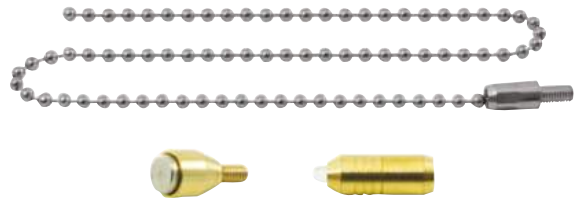

MightyRods 3pc Super Kit Accessory Pack

Upgrade your MightyRod kit with this Super Kit Upgrade Pack.

CONTENTS:
Torch, Magnet and Chain.

Item Number	i	📦
T5441	3 piece	1



MightyRods 10m Cable Rod Set

'Mighty-Fix' zinc plated steel connectors are glued, indented and crimped for ultimate tensile strength in excess of 375kg. Slimline connectors reduce snagging and provide accessibility through smaller holes. 5mmØ rods offer the optimal balance of rigidity and flexibility for the majority of cable routing requirements. High sheen fibreglass and resin composite rods minimise snagging and splintering.

CONTENTS:
10 x 1m rods, cable hook, 190mm coiled steel flexi lead, mini eye & ring, 5mm adapter.

Item Number	↔	📦
T5410	10 x 1m	6



MightyRods Tool Box Cable Rod Set 3.3m

Conveniently sized set for storage in toolbox or tool bag. Ideal for tight access applications. Combined total length of 3.3m. 'Mighty-Fix' connectors, glued, indented and crimped for tensile strength of 375kg. 5mmØ rods offer the optimal blend of rigidity & flexibility.

CONTENTS:

10 x 330mm rods, cable hook, 190mm coiled steel flexi lead, mini eye & ring, 5mm adapter.

Item Number	← →	⊘	📦
TS411	10 x 330mm		6



Pom Draw Tape 30m

High quality draw tape constructed of three intertwining POM (Polyoxymethylene) strands. Helical tape structure for reduced friction and high tensile strength. Flexible head attachment for navigating conduit with multiple bends. Robust plastic casing for convenience during storage and transportation.

Item Number	← →	⊘	📦
495056	30m (98ft)	6mm	1

DRAW TAPES



Steel Wire Draw Tape (POM Coated) 50m

Superior quality draw tape. Constructed from steel core wire and durable POM (Polyoxymethylene) coating. Steel core wire provides optimum rigidity and exceptional tensile strength for effective pushing and pulling of cable through runs of conduit. Abrasion resistant and low friction; the POM coating has material properties that are well suited to cable pulling applications. Fitted with a flexible head and draw eye for minimal resistance whilst navigating cable through conduit with multiple bends.

Item Number	← →	⊘	📦
495055	50m (164ft)	5.5mm	1



Nylon Draw Tape

Nylon Draw Tape for low friction and high strength during cable pulling applications. Flexible head attachment for navigating conduit with multiple bends. Red coloured tape for improved visibility in conduit with existing cables. Robust plastic casing for convenience during tape rewind, storage and transportation. Non-conductive properties for safe working practices.

Item Number	← →	⊘	📦
495050	10m (33ft)	4mm	2
495051	15m (49ft)	4mm	2
495052	20m (66ft)	4mm	2
495053	25m (82ft)	4mm	2
495054	30m (98ft)	4mm	2



Draw Eye For Nylon Draw Tapes 4mm

Draw eye attachment for pulling cable through conduit.
Compatible with C.K Nylon Draw Tapes: C.K 495050 - 495054.

Item Number	Ø	Icon
495058	4mm	6



Electrician's Draw Tape

Lead spring guide for smooth feed & minimal snagging
Special 'Perlon' tape for strength & reliability.

Item Number	Length	Icon
495005	10m	3
495006	20m	3
495007	30m	2



Flexible Head And Draw Eye For Draw Tapes 4mm

Flexible head attachment for navigating conduit with multiple bends.
Draw eye attachment for pulling cable through conduit.
Compatible with C.K Nylon Draw Tapes. C.K 495050-495054.

Item Number	Ø	Icon
495057	4mm	6



Draw Tape Lubricant

Reduced friction whilst pulling cable through conduit. Creates a thin, non-conductive film that won't clog conduit. Odourless and compatible with all common cable insulation materials. Safety data sheet available upon request.

Item Number	Volume	Icon
495059	950ml	6



Electrician's Draw Tape Cassette

Special flexible spring steel for outstanding strength & reliability.
Hooked end for smooth feed & minimal snagging. Integral braking system for non-slip cable pull through.



Item Number	Length	Icon
495008	50ft (15.2m)	1

CABLE & WIRE STRIPPING TOOLS



Automatic Wire Stripper

Designed for fatigue free, repetitive stripping of flat & round cable & wire. Automatic wire size adjustment and stripping length stop for consistent results. Integrated wire cutter and crimping jaws for convenience.

Item Number		
495001	Stripping - 0.2- 6.0mm; Cutting - HRC 40 - 50; Crimping - 0.5 - 6.0mm terminals	3



Armourslice SWA Cable Stripper

Item Number		
T2250	12- 36mm diameter	6
T2255	Pack of 5 replacement blades	6



ARMOURSLICE STRIPS AWAY THE HASSLE

Strips armoured cable up to 50% faster than conventional methods.

- 1 Scores armour strands to a uniform depth for a clean break off
- 2 Rugged metal alloy body with integrated blade holder
- 3 Strips cables from 12mm up to 36mm





ARMOURSLICE™
Strip away the hassle



Cable Stripper - Kabifix

Dual purpose cable stripper and plastic tube cutting tool. Cutting blade automatically repositions from cutting around, to cutting along the sheath for fast and damage free stripping. Adjustable cutting depth for damage free stripping.

Item Number		
430004	6 - 28mm diameter	3
395041	Spare blade (moving)	10



VDE Cable Sheath Slitting Knife

Specially adapted knife for slitting the outer sheath of cables without damaging inner wire insulation. Individually tested to 10,000v for safe live working up to 1,000v.

EN 60900, VDE0682/201, ASTM-F 1505

Item Number		
484005	185mm (3 1/2")	3



Electrician's Knife

Locking pocket knife with a durable, sharp, high carbon steel blade and wire stripping notch for fast and convenient cable & wire stripping.

Item Number		
484001	95mm (3 3/4")	3



VDE Cable Knife - Straight Blade

EN 60900, VDE0682/201, ASTM-F 1505

Item Number		
484006	180mm (7")	3



VDE Cable Knife - Hooked Blade

EN 60900, VDE0682/201, ASTM-F 1505

Item Number		
484007	175mm (6 1/2")	3

CABLE CUTTING



Heavy Duty Ratchet Cable Cutter

High-grade special tool steel cutting jaws, forged and hardened for an extended working life. Heavy duty ratchet action for the effortless cutting of large diameter cable. Suitable for copper and aluminium cables up to 52 mmØ and SWA cable up to 36 mmØ.

Item Number				
T3678	Cu/Al 52mm	SWA 36mm	-	1
Z3678 1	-	-	Spare blade (moving)	3
Z3678 2	-	-	Spare blade (fixed)	3



Ratchet Cable Cutter - Ratchet

Heavy duty, ratchet action cutters for effortlessly cutting of large diameter cable. Hardened chrome molybdenum steel blade specially designed for cutting hard drawn copper, aluminium cable or 200 pair communications cable. (Not for use on steel armoured cable)

Item Number				
430007	190mm (7 1/2")	32mm	-	3
Z3677 1	-	-	Spare blade (moving)	3
Z3677 2	-	-	Spare blade (fixed)	3



Heavy Duty Cable Shears

High-grade special tool steel cutting jaws, forged and hardened for an extended working life. Parrot-beak cutting jaws to prevent cable slippage. For large diameter copper and aluminium cables up to 27 mmØ. Not for use on steel or ACSR cable.

Item Number		
T3679	27mm	1



Cable Snips

Fast and efficient cutting of aluminium & copper wires and plastic sheathed cables. Stainless steel razor sharp shearing blades for outstanding cutting performance. Spring assisted blade opening with safety closing catch. PVC coated handles for comfort and grip.

Item Number		
430008	165mm (6 1/2")	3



Electrician's Scissors

Heavy duty design for shearing soft cables, insulation materials, tape, cable ties, etc. Micro serrated stainless steel blades, hollow ground for self sharpening, superior cutting performance. Integrated cutting notch for effective cable & wire stripping. Belt pouch for convenient storage.

Item Number		
492001		6



Fibre Optic Scissors

Specially designed for cutting DuPont™ Kevlar® fibres in fibre optic cables - also suitable for cutting DuPont™ Kevlar® webbing, plastic canvas, upholstery and many other materials. High carbon alloy steel with molybdenum and vanadium blades, hardened for long lasting cutting performance - guaranteed for up to 1000 cuts. Precision hollow-ground, micro-serrated jaw prevents the fibres from slipping and ensures a clean cut. Ergonomic, thermoplastic moulded handles allow for left and right handed users. Cutting length: 42mm (1 5/8").

Item Number		
T4505	160mm (6 1/4")	12

CABLE TIE GUNS



Cable Tie Gun

Designed for automatic tensioning and trimming of cable ties. Tension adjuster for the perfect tensioning of different widths of cable ties.

Item Number		
495003	2.4mm - 4.8mm	12



Cable Tie Gun - Heavy Duty

Designed for automatic tensioning and trimming of cable ties. Heavy duty stainless steel construction for outstanding long term performance. Tension adjuster for the perfect tensioning of different widths of cable ties.



Item Number		
495004	4.7mm - 13mm	10

MAINSTESTERS



Mainstester 100-500V AC

One piece moulded handle with insulation for assured safety. High visibility permanently sealed neon tube for safety. Top quality chrome vanadium blade for long life performance, chrome plated for corrosion protection.



Item Number			
440005	65mm	3mm	6



Mainstester Long VDE 220-250V AC

VDE approved mainstester for assured safety. Neon light for high visibility.

DIN 57680-6 VDE 0680-6



Item Number			
440012	100mm	4mm	12



Mainstester VDE 220-250V AC

VDE approved mainstester for assured safety. Neon light for high visibility. Pocket clip.



DIN 57680-6 VDE 0680-6

Item Number			
440007	65mm	3mm	12



Mainstester Heavy Duty 100-250V AC

Extended shaft for long reach applications. Insulated for protection. Neon light for high visibility.

Item Number			
440013	120mm	4mm	12



Mainstester VDE 125-250V AC

Premium quality VDE approved mainstester for assured safety. Neon light for high visibility. Finger slip guard for added safety. Integrated pocket clip.

DIN 57680-6 VDE 0680-6

Item Number			
440008	150mm (6")	3mm	12
440009	190mm (7 1/2")	3.5mm	12



Mainstester Display Box - 20 Piece 100-250V AC

Item Number		
540014	Box of 440013	1

VOLTAGE DETECTORS



Non-Contact Voltage Detector With Visual Indicator

Suitable for non-contact AC voltage tests, earthing / ground connection checks, proper connection check, broken wire detection. High sensitivity tester, offering an extensive non-contact voltage detection range of 70-1000V AC. Bright red LED illumination on detection of AC voltage. Installation category CAT IV 1000V offers protection against transient voltage spikes for the safe testing of fixed installations. Double insulated to ensure safe use near live circuitry. Ergonomic dual component body constructed with handy pocket clip. On/Off button for longer battery life. Uses 2 x 1.5V AAA batteries (Not supplied)

CE, Class III insulation

Item Number		
T2271A	Visual Indicator	6



Voltage Detector Mixed Counterbox

CONTENTS:

5 x non-contact voltage detector – visual indicator, 5 x non-contact voltage detector – audible / visual indicator.

Item Number		
T2272MCBOX	5 of each T2271 & T2272	1



Non Contact Voltage Detector Visual & Audible

Suitable for non-contact AC voltage tests, earthing / ground connection checks, proper connection check, broken wire detection. High sensitivity tester, offering an extensive non-contact voltage detection range of 70-1000V AC. Bright red LED illumination and audible alarm on detection of AC voltage. Installation category CAT IV 1000V offers protection against transient voltage spikes for the safe testing of fixed installations. Double insulated to ensure safe use near live circuitry. Ergonomic dual component body constructed with handy pocket clip. On/Off button for longer battery life. Uses 2 x 1.5V AAA batteries (Not supplied)

CE, Class III insulation

Item Number		
T2272A	Visual/Audible Indicator	6

SWITCH KEYS



Switch Key - Universal 7 in 1

Compact pen-style design offering 7 key types. Tough glass reinforced nylon construction - strong & light weight. Modulo size 2 screwdriver bit included.

Key types included:

Hex x1, Square x3 (small, medium & large), cupboard x1, triangular x1 (medium) and modulo x1.

Item Number		
T4451-1		6

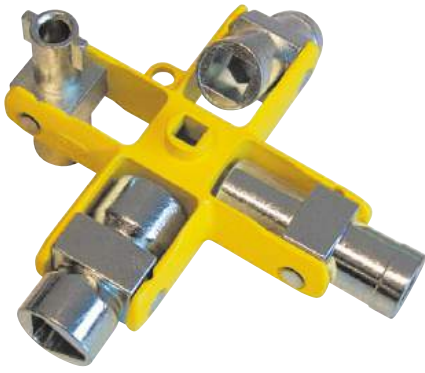

Switch Key - Universal 9 in 1

PH2 screwdriver bit included.

Key types included:

Hex x1, Square x3 (small, medium & large), Triangular x3 (small, medium & large), cupboard x1 and flattened round x1.

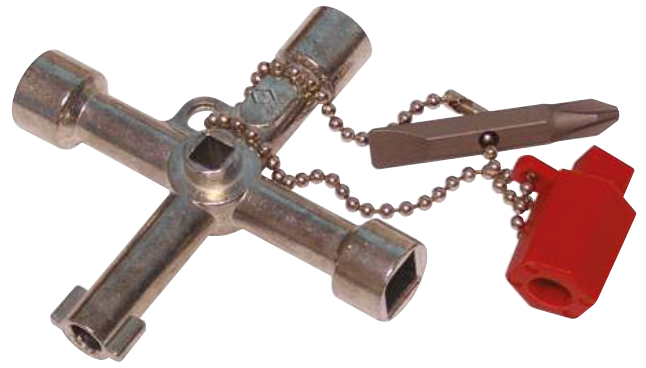

Switch & Cabinet Key - Universal 8 in 1 (Type 2)

Key types included:

Phillips x1, slotted x1, square x3 (small, medium & large) and cupboard x1.

Item Number



T4451-2

6

Item Number



495002

10



Switch & Cabinet Key - Universal 8 in 1 (Type 1)

6mm bit driver adapter & double ended screwdriver bit included.

Key types included:

Phillips x1, slotted x1, square x3 (small, medium & large), cupboard x1, triangular x1 (medium) and tapered square x1.



Universal Switch Key 6 in 1

A multipurpose tool designed for use on the locking systems of electrical, gas and water cupboards in industry and on technical equipment in buildings such as air conditioning, stop valves, mains consoles, doors etc.

Item Number



495015

10

Item Number



T4454

6

CONDUIT BUSH WRENCH



Conduit Bush Wrench

Innovative head design allows for all sizes of conduit bushes to be tightened / Untightened even with cabling inside. Zinc phosphate plated, toughened alloy steel for strength and durability. Soft grip tri-lobe handle for exceptional comfort and control.

Item Number		
T4755	190mm (7 1/2")	6

SOLDERING IRONS & ACCESSORIES



Soldering Irons

High quality, heavy duty construction for professional use. Long life tips suitable for use with lead free solder. Individually tested to 10,000V for safe live working up to 1,000V.

CE, GS, VDE

Item Number		
495009	Soldering iron 25W - UK 3 pin plug	1
495010	Soldering iron 40W - UK 3 pin plug	1
495011	Soldering iron 25W - Euro 2 pin plug	1
495012	Soldering iron 40W - Euro 2 pin plug	1
495013	Spare tip set for 25W	1
495014	Spare tip set for 40W	1



Soldering Wires

Lead free special alloy.

EN 61190

Item Number			
T6052 51	500g	1mm	3
T6052 52	500g	2mm	3

PUNCH DOWN TOOL



Punch Down Tool

For the fast and secure seating of data wires into terminals - suitable for a wide range of terminal block types. One step action for automatic seating & trimming of excess wires. Handle includes wire extractor hook & spudger.

Item Number		
495033	180mm (7")	3

RE-THREADING TOOLS

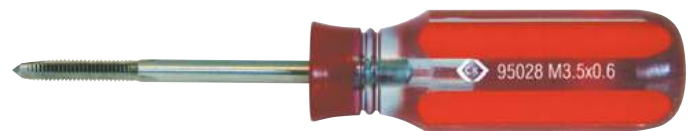

Re-Threading Tools

Precision ground, HSS tap for a clean, accurate cut & long life. 50mm tap length for improved access. Shatter resistant acetate handle for damage protection.

Item Number			
495028	M3.5	0.6mm	12
495029	M4	0.7mm	12

TOOL KITS



Electrician's Premium Tool Kit - UK

Constructed specifically for the professional electrician or technician, the C.K Magma Electrician's Premium Tool Kit 595003 is an extensive collection of the most commonly used tools including the award winning C.K Combicutter3 side cutters and premium quality 1000V insulated C.K dextroVDE screwdrivers. The kit is supplied together with the multiple award winning C.K Magma Technician's Tool Case.

CONTENTS: Technican's tool case. Redline VDE Combicutter3 165mm . Combination pliers 185mm. Snipe nose pliers 175mm. 1x dextroVDE screwdrivers, slotted, sizes: 2.5 x 75 & 4 x 100mm; PZ, size: 1 x 80 & 2 x 100mm; PH, sizes: 1 x 80 & 2 x 100mm; Modulo, size: 2. VDE mainstester. ST tape 5m/16ft. Junior hacksaw. Electrican's knife. Automatic wire strippers. Pocket level. RE-threading tool M3.5. Claw hammer.

Item Number		
595003	19 piece kit	1



Core Tool Kit

A quality tool kit comprising of the 'must-have' tools all contained within a handy, space saving C.K Magma Tool Roll.

CONTENTS:
C.K Magma Tool Roll, C.K Retractable Trimming Knife, C.K ST Tape Measure 10ft/3m, C.K Classic Combination Pliers 180mm, C.K Steel Claw Hammer 8oz, C.K Ratchet Screwdriver with 10 bits, C.K Junior Hacksaw.

Item Number		
T5957	18 piece set	1



Electrician's Premium Tool Kit - European

CONTENTS: Technican's tool case. Redline VDE side cutters 165mm. Combination pliers 175mm. Snipe nose pliers 175mm. 1 x dextroVDE screwdriver, slotted, sizes: 2.5 x 75 & 4 x 100mm; PZ, sizes: 1 x 80 & 2 x 100mm; Modulo sizes: 1 & 2. VDE mainstester. ST tape 8m. Mini hacksaw. Electrican's knife. Automatic wire strippers. Cable knife. Plasterboard saw.

Item Number		
T1630 FKIT	17 piece kit	1



Electrician's Tool Tote Kit

Constructed specifically for the professional Electrician, the C.K Electrician's Tool Tote Kit T5952 comprises of the most commonly used electricians tools including the C.K RedLine VDE pliers and premium quality C.K dextroVDE screwdrivers. The tool kit is supplied together with the robust C.K Magma Technician's Tool Tote.

CONTENTS:
C.K Magma Technicians Tool Tote, C.K RedLine VDE Side Cutters 160mm, C.K Redline VDE Combination Pliers 180mm, C.K Redline VDE Snipe Nose Pliers 175mm, C.K dextroVDE Screwdriver PZD 1, C.K dextroVDE Screwdriver PZD 2, C.K dextroVDE Screwdriver slotted 2.5mm, C.K dextroVDE Screwdriver slotted 4.0mm, C.K dextroVDE Screwdriver slotted 5.5mm, Trimming Knife, ST Tape measure 10ft/3m, Junior Hacksaw, Spirit level, Voltage detector.

Item Number		
T5952	14 piece kit	1



Electrician's Core Tool Kit

Constructed specifically for the professional Electrician, the C.K Electrician's Core Tool Kit T5951 comprises of the most commonly used electricians tools including the C.K RedLine VDE pliers and premium quality 1000v insulated C.K dextroVDE screwdrivers. The tool kit is supplied together with the convenient C.K Magma Essential Tool Pouch.

CONTENTS:

C.K Magma Essential Tool Pouch, C.K RedLine VDE Side Cutters 160mm, C.K Redline VDE Combination Pliers 180mm, C.K dextroVDE PZD 2, C.K dextroVDE slotted 2.5mm, C.K dextroVDE slotted 4.0mm.



VDE Pliers & Screwdrivers Kit (PH)

C.K tools T5954 Insulated RedlineVDE pliers and dextroVDE screwdrivers kit in a protective durable polyester zipped storage wallet. It's not only an ideal electrician's starter tool kit, it's a great kit to upgrade your tool box with premium quality C.K pliers & screwdrivers.

CONTENTS:

C.K Redline VDE Side Cutters 160mm, C.K Redline VDE Combination Pliers 180mm, C.K Redline VDE Snipe Nose pliers 170mm, C.K dextroVDE Screwdriver, slotted parallel tip 2.5x75mm, 3.0x100mm & 5.5x125mm. PH tip 1x80mm and 2x100mm, C.K Non Contact Voltage Detector, C.K Zipped Storage Wallet.

Item Number		
T5951	6 piece kit	1

Item Number		
T5954	10 piece kit	1



VDE Pliers & Screwdrivers Kit (PZ)

C.K tools T5953 Insulated RedlineVDE pliers and dextroVDE screwdrivers kit in a protective durable polyester zipped storage wallet. It's not only an ideal electrician's starter tool kit, it's a great kit to upgrade your tool box with premium quality C.K pliers & screwdrivers.

CONTENTS:

C.K Redline VDE Side Cutters 160mm, C.K Redline VDE Combination Pliers, 160mm, C.K Redline VDE Snipe Nose pliers 170mm, C.K dextroVDE Screwdriver, slotted parallel tip 2.5x75mm, 3.0x100mm & 5.5x125mm. PZD tip 1x80mm and 2x100mm, C.K Non Contact Voltage Detector, C.K Zipped Storage Wallet.



Data Communications Tool Kit

Constructed specifically for the professional data communications engineer, the C.K Data Comms Kit T5955 comprises of premium quality German manufactured precision pliers & screwdrivers, ratchet crimper, wire stripper and punchdown tool.

CONTENTS:

C.K Punch down tool, Jokari datacom cable stripper, C.K Ratchet crimping Pliers - Modular plugs, C.K Classic Precision Side Cutters, C.K Precision Xonic Screwdriver Set, C.K Precision Classic Snipe Nose Pliers, C.K Zipped Storage Wallet

Item Number		
T5953	10 piece kit	1

Item Number		
T5955	11 piece kit	1



Technician's Tool Kit

Constructed specifically for technicians and electrical service engineers, the C.K Technician's Tool Kit T5956 comprises of premium quality German manufactured precision pliers & screwdrivers, wire stripper and inspection tools.

CONTENTS:

C.K Xonic ESD 7 Piece Screwdrivers Set, C.K Sensoplus ESD Side Cutters, C.K Sensoplus ESD Snipe Nose Pliers, C.K Precision Wire Stripper, C.K Inspection Mirror, C.K Tweezers, C.K ESD Bit Driver, C.K 32 Piece Screwdriver Bit Set, C.K Zipped Storage Wallet.

Item Number		
T5956	46 piece kit	1



Solar PV Installation Toolkit

CONTENTS:

Ratchet crimping pliers for secure crimping of MC3 and MC4 Solar PV cable connectors (2.5, 4.0 & 6.0mm² Cable). Cable shears for effortless clean cutting of all sizes of Solar PV cable. Dedicated Solar PV wire stripping tool for correct length stripping of all types of Solar PV cable (2.5, 4.0 & 6.0mm² Cable). Convenient storage case.

Item Number		
T3672	3 piece set	1



Tool Wallet

Tough fabric zip up carry case with elasticated internal loops. 340mm x 245mm with expansion of up to 65mm to accommodate tools.

Item Number	
316001	1

SERVICE CASES



Rigid Service Case

Tough ABS plastic service case with aluminium frame for the safe transportation of tools and equipment. Contains over 40 pockets and straps, 14 adjustable compartments and a fixed document compartment making this case ideal for a wide range of service engineer trades.

Item Number	
T1643	1

HAMMERS

66-69

PLASTERING TOOLS

76-77

GLUE GUNS

85

WRECKING TOOLS

70

PADDLES & MIXERS

77

CHISELS & BOLSTERS

70-72

PLUMBING

78-79

**PROFESSIONAL SOFT GRIP
TROWELS**

72-73

TILING & GLAZING

80-81

**TRADITIONAL HARD WOOD
TROWELS**

73-75

BRADAWLS

81-82

STAINLESS STEEL TROWELS

75

SCRAPERS & FILLING KNIVES

82-83

BRICK JOINTER

75

STAPLE GUNS

83-84



BUILDING & PLUMBING





ANTI-VIBRATION HAMMERS

- 1 Single piece drop forged high carbon steel head and shaft - hardened and tempered for superior strength and durability
- 2 Balanced weight design with energy saving claw geometry for improved performance
- 3 Contoured anti-vibe shock absorbing grip system to protect against injury through shock
- 4 Polished and lacquered to protect against corrosion



HAMMERS



Claw Hammers - Anti-Vibration One Piece Forged

Item Number		
357001	454g (16oz)	6
357002	568g (20oz)	6



Claw Hammers - Anti-Vibration Fibreglass Shaft

Drop forged high carbon steel head - hardened & tempered for superior strength and durability. Tough fibreglass shaft for strength. Contoured anti-vibe shock absorbing grip system. Polished and lacquered to protect against corrosion.

Item Number		
357003	454g (16oz)	6
357004	568g (20oz)	6



Club Hammer - Anti-Vibration One Piece Forged

Single piece drop forged high carbon steel head & shaft - hardened & tempered for superior strength and durability. Contoured anti-vibe shock absorbing grip system. Polished and lacquered to protect against corrosion.

Item Number		
357005	1361g (3lb)	2



Claw Hammers - Hi-Vis

Drop forged high carbon steel head - hardened & tempered for superior strength and durability. Tubular steel shaft - strong & lightweight. Hi-vis handle for increased visibility in low light conditions. Black lacquered to protect against corrosion.

Item Number		
T4229 08	227g (8oz)	6
T4229 16	454g (16oz)	6
T4229 20	568g (20oz)	6



Club Hammers



Drop forged high carbon steel head - hardened & tempered for superior strength and durability. Black lacquered to protect against corrosion. Tough hickory shaft to withstand high impact applications.

Item Number		
T4219 40	1135g (2 1/2lb)	2
T4219 64	1816g (4lb)	2



Club Hammers - German Pattern



Drop forged high carbon steel head - hardened & tempered for superior strength and durability. Black lacquered to protect against corrosion. Traditional ash shaft.

Item Number		
T4219A 10	1000g (2 1/4lb)	6
T4219A 15	1500g (3 1/2lb)	6



Brick Hammers

Drop forged high carbon steel head - hardened & tempered for superior strength and durability. Accurately ground chisel end for clean cutting. Tubular steel shaft - strong & lightweight.

Item Number		
T4232 16	454g (16oz)	4
T4232 20	568g (20oz)	4



Sledge Hammers



Drop forged high carbon steel head - hardened & tempered for superior strength and durability. Vibration damping fibreglass shaft for strength & protection. Rubber overstrike collar protects against damage & transmitted shock.

Item Number		
T421808	3.63kg (8lb)	2
T421812	5.44kg (12lb)	2



Ball Pein Hammers

Drop forged high carbon steel head - hardened & tempered for superior strength and durability. Black lacquered to protect against corrosion. Tough hickory shaft for durability. Ball pein for setting rivets.

Item Number		
T4208H 08	227g (1/2lb)	3
T4208H 16	454g (1lb)	3
T4208H 24	682g (1 1/2lb)	3
T4208H 32	908g (2lb)	3



Mortar Pick

Drop forged high carbon steel head - hardened & tempered for superior strength and durability. Tubular steel shaft - strong & lightweight.

Item Number		
T4234	chisel and point	6



Joiner's Hammers

Drop forged high carbon steel head - hardened & tempered for superior strength and durability. Black lacquered to protect against corrosion. Tough hickory shaft for durability. Cross pein for easy starting of small nails & pins.

Item Number		
T4204 06	171g (6oz)	3
T4204 08	227g (8oz)	3
T4204 10	284g (10oz)	3



Electrician's Hammer - French Pattern

Drop forged high carbon steel head - hardened & tempered for superior strength and durability. Black lacquered to protect against corrosion. Traditional ash shaft for strength.

Item Number		
356001	200g (7oz)	12



Pin Hammer

Drop forged high carbon steel head - hardened & tempered for superior strength and durability. Black lacquered to protect against corrosion. Tough hickory shaft for durability. Cross pein for easy starting of small nails & pins.

Item Number		
T4203	114g (4oz)	3



Engineer's Hammers - German Pattern

Drop forged high carbon steel head - hardened & tempered for superior strength and durability. Black lacquered to protect against corrosion. Traditional ash shaft for strength.

DIN 1041

Item Number		
T4227A 0100	100g (3 1/2oz)	12
T4227A 0200	200g (7oz)	12
T4227A 0300	300g (10 1/2oz)	12
T4227A 0500	500g (17 1/2oz)	12
T4227A 1000	1000g (35oz)	6



Engineer's Hammer - French Pattern

Drop forged high carbon steel head - hardened & tempered for superior strength and durability. Black lacquered to protect against corrosion. Traditional ash shaft for strength.

Item Number		
356002	300g (10 1/2oz)	12
356003	400g (14oz)	3

WRECKING TOOLS



Prybar, Nail Puller & Scraper

Forged spring steel for strength and durability. Specially contoured & notched for efficient nail pulling and prying. Sharp angle ground ends for effective chiseling & scraping.

Item Number	↔	📦
T4310	380mm (15")	6



Wrecking Bars

High grain carbon steel, hardened and tempered for strength and durability. Chisel end & goose neck end with nail pulling notch ideal for heavy duty levering and dismantling work.

Item Number	↔	📦
T431418	455mm (18")	1
T431424	610mm (24")	1



Slaters Ripper

Single piece forged spring steel construction for strength & durability. Slim blade design with double sided hooked blades for fast & effective nail cutting.

Item Number	📦
T5180	1

CHISELS & BOLSTERS



Brick Bolsters - With Grip

Hand guard for increased comfort & protection from overstrike.

BS 3066

Item Number	↔	↕	📦
T30875 3	230mm (9")	75mm (3")	10
T30875 4	230mm (9")	100mm (4")	10



Brick Bolsters

Octagonal shank brick bolster with precision ground cutting edges hardened and tempered to BS3066 for long term performance. Specifically designed for cutting bricks and composite blocks. Powder coated for corrosion protection.

BS 3066

Item Number	↔	↕	📦
T3087 3	230mm (9")	75mm (3")	10
T3087 4	230mm (9")	100mm (4")	10



Electrician's Bolsters

Octagonal shank electricians bolster with precision ground cutting edges hardened and tempered to BS3066 for long term performance. Ideal for splitting and lifting floorboards, cutting plaster and chasing. Powder coated for corrosion protection

BS 3066

Item Number	↔	↕	📦
T3086	225mm (8 3/4")	55mm (2 1/4")	10



Electrician's Bolsters - With Grip

Hand guard for increased comfort & protection from overstrike.

BS 3066

Item Number	↔	⤴	📦
T3086S	225mm (8 3/4")	55mm (2 1/4")	10



Plugging Chisel

Angled & grooved cutting edge for the effective removal of mortar & cement.

BS 3066

Item Number	↔	⤴	📦
T3088	250mm (10")	25mm (1")	10



Cold Chisels

Octagonal shank with precision ground cutting edges hardened and tempered to BS3066 for long term performance. Designed for cutting small section steel, can also be used on brick and concrete. Powder coated for corrosion protection.

BS 3066

Item Number	↔	⤴	📦
T3383 06	150mm (6")	12mm (1/2")	10
T3383 07	180mm (7")	16mm (5/8")	10
T3383 08	200mm (8")	19mm (3/4")	10
T3383 10	250mm (10")	19mm (3/4")	10
T3383 18	460mm (18")	19mm (3/4")	10
T3383 101	250mm (10")	25mm (1")	10
T3383 12	300mm (12")	25mm (1")	10



Scutch Chisel

Octagonal shank chisel with a recessed end to accept plain or tooth edged (comb) scutch bits. Supplied complete with one replaceable comb bit.

BS 3066

Item Number	↔	📦
406001	25mm (1")	3
406002	38mm (1 1/2")	3

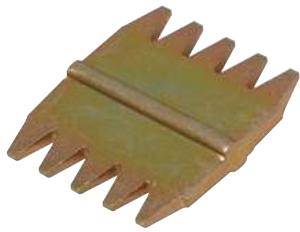

Scutch Chisel - Spare Bits

10 spare comb bits for 25mm scutch chisel.

Item Number	← →	i	📦
T4211/1	25mm (1")	Scutch combs	1
T4211/2	25mm (1")	Scutch droves	1
T4211/3	38mm (1 1/2")	Scutch combs	1
T4211/4	38mm (1 1/2")	Scutch droves	1



Bolster Chisels Display

CONTENTS:

7 x plugging chisels. 7 x electrician's bolster chisels. 6 x bolster chisels, sizes: 75 & 100mm. 3 x bolster chisels with grip, size: 100mm.

BS 3066

Item Number	i	📦
T3090LS	Stock & stand	1



Cold Chisels Display

CONTENTS:

8 x cold chisels, size: 12 x 150mm. 7 x cold chisels, size: 16 x 180mm. 6 x cold chisels, sizes: 19 x 200 & 19 x 250mm. 5 x cold chisels, sizes: 25 x 250 & 25 x 300mm.

BS 3066

Item Number	i	📦
T3389LS	Stock & stand	1

PROFESSIONAL SOFT GRIP TROWELS

- High carbon steel blade, hardened & taper ground for the optimum balance of strength & flexibility.
- Heavy duty tang welded to blade for strength & durability.
- Patented soft grip handle with finger guard for comfort & control.



Brick Trowel - Broad Heel

Item Number	← →	📦
T529510	255mm (10")	3



Brick Trowel - Philadelphia

Item Number	← →	📦
T529311	280mm (11")	3



Pointing Trowel

Item Number	↔	
T529606	150mm (6")	3



Gauging Trowel

Item Number	↔	
T529207	180mm (7")	6



Finger Trowel

Item Number	↔	
T529750	175 x 13mm (7" x 1/2")	3

TRADITIONAL HARD WOOD TROWELS

- High carbon steel blade, hardened & taper ground for the optimum balance of strength & flexibility.
- Heavy duty tang welded to blade for strength & durability.
- Traditional wooden handle.



Brick Trowels - Broad Heel

Item Number	↔	
T527010	250mm (10")	6
T527011	275mm (11")	3



Brick Trowel - Philadelphia

Item Number	↔	
T527111	275mm (11")	1



Pointing Trowels

Item Number	↔	📦
T5060 4	100mm (4")	3
T5060 5	125mm (5")	3
T5060 6	150mm (6")	6

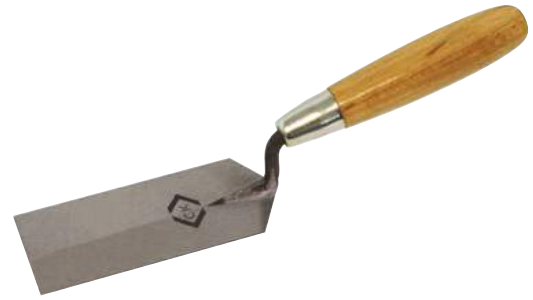

Margin Trowel

Item Number	↔	📦
T5273	125mm (5")	3



Gauging Trowel

Item Number	↔	📦
T527207	175mm (7")	3

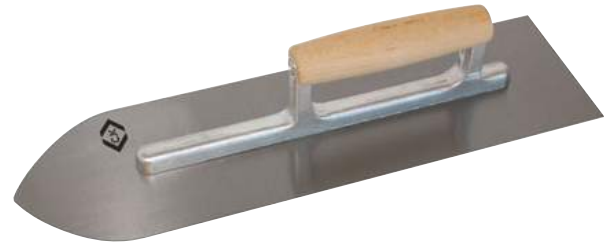

Flooring Trowel

High carbon steel blade, hardened & tempered for the optimum balance of strength & flexibility. Welded & riveted tang to blade joint for outstanding durability. Traditional wooden handle.

Item Number	↔	📦
T5264	405 x 115mm (16 x 4 1/2")	3



Finger Trowels

High carbon steel flat blade. T5073 1 with half round blade.

Item Number	↔	🔪	📦
T5073 37	175mm (7")	10mm (3/8")	3
T5073 50	175mm (7")	13mm (1/2")	3
T5073 62	175mm (7")	16mm (5/8")	3
T5073 75	175mm (7")	19mm (3/4")	3
T5073 99	175mm (7")	25mm (1")	3
T5073 1	175mm (7")	13mm (1/2")	3



Edging Trowel

Heavy duty carbon steel blade for strength. 6 rivet blade joint for durability. Traditional wooden handle.

Item Number	↔	📦
T5274	280 x 115mm (11 x 4 1/2")	3



Harling Trowel

Heavy gauge steel blade with tang welded to blade for strength & durability. Traditional wooden handle.

Item Number	↔	📦
T5097	165 x 165mm (6 1/2 x 6 1/2")	2



Gauging Trowel

Item Number	↔	📦
T524207	175mm (7")	3

STAINLESS STEEL TROWELS

- Stainless steel blade for corrosion protection & low maintenance.
- Heavy duty tang welded to blade for strength & durability.
- Patented soft grip handle with finger guard for comfort & control.



Brick Trowel - Philadelphia

Item Number	↔	📦
T524111	280mm (11")	3



Brick Jointer

Fully hardened & tempered carbon steel for wear resistance.

Item Number	↔	📦
T5198	13 x 16mm (1/2 x 5/8")	12



Pointing Trowel

Item Number	↔	📦
T524306	150mm (6")	6

PLASTERING TOOLS



Plasterer's Trowel - Steel, Soft Grip

High carbon steel blade, hardened & tempered for the optimum balance of strength & flexibility. Welded & riveted tang to blade joint for outstanding durability. Soft grip handle for comfort & control.

Item Number	↔	📦
T5298	280 x 120mm (11 x 4 3/4")	6



Plasterer's Trowel - Stainless Steel, Large

Stainless steel blade for corrosion protection & low maintenance. Welded & riveted tang to blade joint for outstanding durability. Traditional wooden handle.

Item Number	↔	📦
T5299	330 x 120mm (13 x 4 3/4")	6

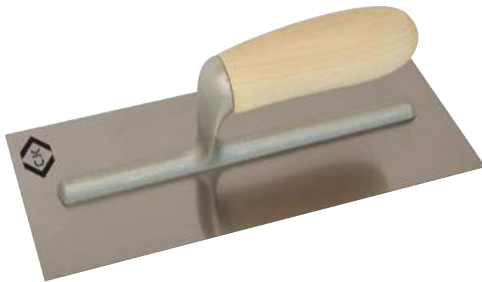

Plasterer's Trowel - Steel

High carbon steel blade, hardened & tempered for the optimum balance of strength & flexibility. Welded & riveted tang to blade joint for outstanding durability. Traditional wooden handle.

Item Number	↔	📦
T5068	280 x 120mm (11 x 4 3/4")	6



Plasterer's Hawk

Lightweight aluminium blade with grooved, non-slip surface.

Item Number	↔	📦
T5069	300 x 300mm (12 x 12")	3

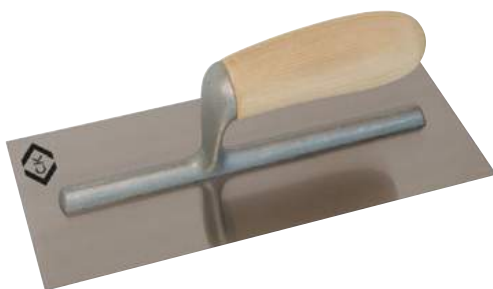

Plasterer's Trowel - Stainless Steel

Stainless steel blade for corrosion protection & low maintenance. Welded & riveted tang to blade joint for outstanding durability. Traditional wooden handle.

Item Number	↔	📦
T5072	280 x 120mm (11 x 4 3/4")	6



Skimmer Floats

Lightweight, moulded foam polymer with fine chequered working face - durable & non-warping.

Item Number	↔	📦
T5172	280 x 140mm	1
T5172 18	320 x 180mm	1



Trowel & Square Tools

Solid forged steel blade, hardened, tempered & ground for the optimum balance of flexibility & strength.

Item Number	←→	🔧	📦
T5093 50	265mm (10 1/2")	12mm (1/2")	3
T5093 62	265mm (10 1/2")	16mm (5/8")	3
T5093 75	265mm (10 1/2")	19mm (3/4")	3



Leaf & Square Tool

Solid forged steel blade, hardened, tempered & ground for the optimum balance of flexibility & strength.

Item Number	←→	🔧	📦
T5091 50	200mm (8")	12mm (1/2")	3

PADDLES & MIXERS



Drill Mixers

Nickel plated steel construction for strength & easy cleaning. Suitable for use with electric drills at speeds between 200 - 700 rpm.

Item Number	←→	📦
T1881	420mm (16 1/2")	4
T1882	620mm (25")	4



Plasterer's Paddle

Strong and light weight construction featuring a die cast aluminium paddle mounted on a steel T handle. Also suitable for mixing mortar, concrete, paint etc.

Item Number	←→	📦
T1885	790mm (31")	1

PLUMBING



Pipe Cutters - 3-30mm

Adjustable pipe cutter for copper, brass, Aluminium and thin walled steel pipe. Capacity 3 – 30mm diameter. Easy grip handle. New longer life 'easy glide' steel insert body threads. Replaceable hardened steel cutting blade for long life performance. No tools required for convenience. Black die cast lacquered body for strength and corrosion resistance.

Item Number	Ø	📦
T2231A	3-30mm	5



Pipe Cutters - 3-25mm

Compact adjustable mini pipe cutter for copper, brass, Aluminium and thin walled steel pipe. Capacity 3 – 25mm diameter. New longer life 'easy glide' steel insert body threads. Replaceable hardened steel cutting blade for long life performance – No tools required for convenience. Black die cast lacquered body for strength and corrosion resistance.

Item Number	Ø	📦
T2232A	3-25mm	10



Pipe Cutter - Spare Wheel

Suitable for T2231 & T2232 Pipe Cutters.

Item Number	Ø	📦
T2235	19.5mm	10



Basin Wrench

Adjustable, telescopic wrench with sliding T handle for confined & long reach access. Spring loaded, self adjusting jaws maintain an automatic grip. 180° swivelling head for clockwise or anti-clockwise action. Hardened steel jaws for durability.

Item Number	↔	📦
T4311	275 - 460mm	6



Immersion Heater Spanner

One piece steel construction for strength & durability. Zinc plated for corrosion protection. PVC handle for comfort and grip.

Item Number	🔧	📦
T4347	85mm	6



PVC Pipe & Conduit Cutter - Ratchet

Heavy duty aluminium body - Strong & light. Ratchet action razor sharp stainless steel blade for effortless cutting of; PVC conduit, blue water mains, plastic pipe, rubber hose, pneumatic pipe, electrical sleeving, etc. Complete with special adaptor for straight or mitre cutting of small rectangular cross-section trunking.

Item Number	↔	∅	📦
430003	220mm	32mm	3



Multi Cutter Set

Heavy duty aluminium body. Lever action razor sharp stainless steel blade for cutting; PVC conduit, plastic pipe, rubber hose, pneumatic pipe, wooden dowel, etc. 5 interchangeable anvils (flat, double radius, single radius, 90° square and mitre) allow both straight and mitred cuts.

Item Number	📦
T2240	3



PVC Pipe & Conduit Cutter

Glass fibre reinforced polycarbonate body - Strong & light. Razor sharp stainless steel blade for efficient cutting of: PVC conduit, blue water mains, plastic pipe, rubber hose, pneumatic pipe, electrical sleeving, etc.

Item Number	↔	∅	📦
430001	195mm	28mm	3



Stillson Wrenches

High quality drop forged steel construction with hardened & tempered jaws for strength & durability. Patented head design for high torque performance. Non slip, durable finish for grip and control.

Item Number	↔	🔄	📦
T3735 300	300mm (12")	38mm	8
T3735 350	350mm (14")	55mm	8
T3735 450	450mm (18")	55mm	8
T3735 600	600mm (24")	70mm	4



Plumbing Spanner - Single Ended

High quality drop forged steel construction, hardened & tempered for strength & durability.

DIN 894

Item Number	↔	🔄	📦
T4382 039	300mm	39mm	3

TILING & GLAZING



Tile Scribe

Tungsten carbide tipped, suitable for tiles, metal and glass. Pocket clip.

Item Number		
T1531		12



Grouting Float

Lightweight, polymer handle bonded to a dense rubber pad - suitable for grout application.

Item Number		
T5174	280 x 140mm (11 x 5 1/2")	1



Adhesive Trowels

Item Number		
T5170 1	280 x 115 x 20mm (11 x 4 1/2" x 3/4")	3
T5170 2	280 x 115 x 20mm (11 x 4 1/2" x 1/4")	3



Glass Cutter

High quality with 6 premium quality tungsten carbide blades in turret head. Oiled felt washer for constant lubrication. Heavy nickel plated head for protection.

Item Number		
T5087		6



Grouting Sponge

Lightweight, polymer handle bonded to a sponge pad - suitable for washing down grout.

Item Number		
T5173	280 x 140mm (11 x 5 1/2")	1



Glass Cutter Blades

12 high quality tungsten carbide blades.

Item Number		
T5089		1

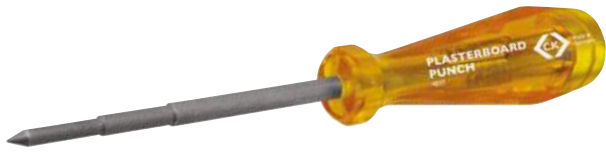

Plasterboard Punch

Stepped, special alloy shaft for punching 5mm, 6mm & 7mm wall plug holes – no drilling, no mess. Cone point for punching, scribing and marking plasterboard. Shatterproof acetate handle with a strike-through cap withstands hammer blows.

Item Number			
T4837	98mm	100mm	3



Suction Lifter - 30kg

Clamp action suction cup designed to lift up to 30kg. Heavy duty construction for strength & durability.

Item Number			
T5081	120mm (4 3/4")	30kg	1

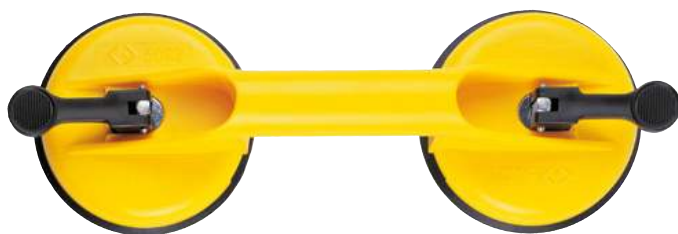

Suction Lifter - 60kg

Lever action, double suction cup designed to lift up to 60kg. Heavy duty construction for strength & durability.

Item Number			
T5082	320mm (12 3/4")	60kg	1

BRADAWLS



Bradawl - Square

Item Number			
T4831 2	100mm (4")	85mm (3 1/4")	6



Bradawl Display Box - 50 Square Assorted Length

Item Number		
T4831	50 in counter box	1



Bradawl - Round

Nickel plated hardened steel blade for a long life. Shatterproof ball ended acetate handle for comfort and safety.

Item Number		
T4835	6mm (7/32")	6



Putty Knife

High quality spring steel blade for strength & flexibility. Clip point profile for smoothing & shaping putty. Rosewood handle.

Item Number		
T5076		1



Filling Knife

Manufactured with a high quality spring steel blade, taper ground to give the optimum flexibility for perfect results. Durable rosewood handle.

Item Number		
T5077 3	75mm (3")	6

SCRAPERS & FILLING KNIVES



Scrapers

High quality, tapered ground spring steel blade for strength. Rosewood handle.

Item Number		
T5075 1	25mm (1")	3
T5075 2	50mm (2")	3
T5075 3	75mm (3")	3
T5075 4	100mm (4")	3



Scraper / Filling Knives

Manufactured with a taper ground, high quality, spring steel blade. Strong enough for scraping yet flexible enough for filling. Plastic wipe clean handle with hanging hole for convenient storage.

Item Number		
T5070A 040	40mm (1 1/2")	6
T5070A 050	50mm (2")	6
T5070A 070	70mm (2 3/4")	6
T5070A 100	100mm (4")	6



Scraper / Filling Knife Display Stand

CONTENTS:
6 x sizes: 40, 50, 70 & 100mm.

Item Number		
T5070A/4LS	Stock & stand	1



Scraper Set - 4 Piece Superflex

Set of 4 super flexible spring steel scrapers. Ideal for removing paint from glass, filling, etc. Fitted with plastic hand guards for safety. Supplied in four widths 50, 80, 100 and 120mm.

Item Number		
T5064	50, 80, 100 and 120mm	1

STAPLE GUNS

- Heavy duty, tough cast aluminium body for strength & durability.
- Bi-material ergonomic handle for comfort & reduced fatigue.
- Unique staple loading & clearing mechanism for fast & convenient use.
- Handle safety locking system prevents accidental operation.



Staple & Nail Gun

Fires staples 6-14mm (interchangeable with Arrow T50 or Rapid 140 6-14mm) & nails (brads) 18 gauge 16mm. Supplied with 200 x 8mm staples.

Item Number	
496001	3



Staples - Square

High quality steel staples, galvanised for corrosion protection - to suit C.K 496001 heavy duty staple gun.

Item Number		
496002	10.5 x 8mm	10
496003	10.5 x 10mm	10
496004	10.5 x 12mm	10
496005	10.5 x 14mm	10



Cable Tacker - Low Voltage Cable

Fires half round staples for use on low voltage cable max 7.5mm diameter (interchangeable with Arrow T25).

Item Number		
T6227	7.5mm	3



Telecom Staples - Half Round

High quality telecom cable staples, galvanised for corrosion protection. White coated tops for discreet fixing - to suit C.K T6228 Telecom cable tacker.

Item Number		
495024	4.8 x 10mm	10



Cable Staples - Half Round

High quality steel cable staples, galvanised for corrosion protection - to suit C.K T6227 cable tacker.

Item Number		
495021	7.5 x 10mm	10
495022	7.5 x 14mm	10



Stapler Display

CONTENTS:
4 x Staple & nail guns. 3 x boxes of square staples, sizes: 8, 10, 12 & 14mm.

Item Number		
T6222-LS	Stock & stand	1



Cable Tacker - Telecom Cable

Fires half round staples for use on telecom data cable max 4.8mm diameter.

Item Number		
T6228	4.8mm	3



Cable Tacker Display

CONTENTS:
2 x Low voltage cable tacker. 2 x telecom cable tacker. 3 x boxes of half round cable staples, sizes: 10 & 14mm. 7 x boxes of half round telecom staples, size: 10mm.

Item Number		
T6224-LS	Stock & stand	1

GLUE GUNS & ACCESSORIES



Glue Gun

Premium quality with high energy heater for fast heating & improved glue flow. Heat insulated nozzle for safety. Integral wire stand for convenience. Glue output of up to 21g/min for fast application. Supplied with two 100mm glue sticks.

CE

Item Number		
T6215	UK 3 pin plug	6
T6215A	Euro 2 pin plug	6

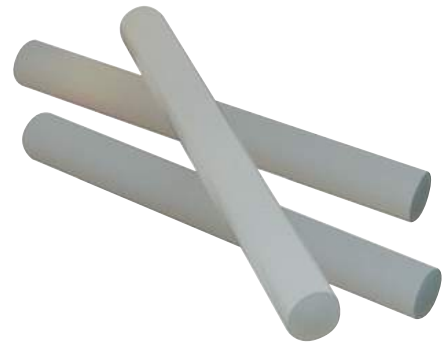

Glue Sticks

All purpose glue sticks for use with C.K 6215 glue gun.

Item Number			
T6218 06	100mm	x 6	6
T6218 25	100mm	x 25	6
T6219 025	200mm	x 25	1
T6219 125	200mm	x 125	1



Glue Gun Kit

CONTENTS:

Glue gun, 12 x glue sticks, size: 200mm.

CE

Item Number		
T6216	Euro 2 pin plug	1

TAPE MEASURES

88-90

FEELER GAUGES

94

RULES

90

POCKET BALANCES

95

SPIRIT LEVELS

91

**CHALK, LINES
& ACCESSORIES**

91-92

**JOINERS SQUARES
& BEVELS**

92-93

COMBINATION SQUARES

94

VERNIER CALIPERS

94



MEASURING & MARKING

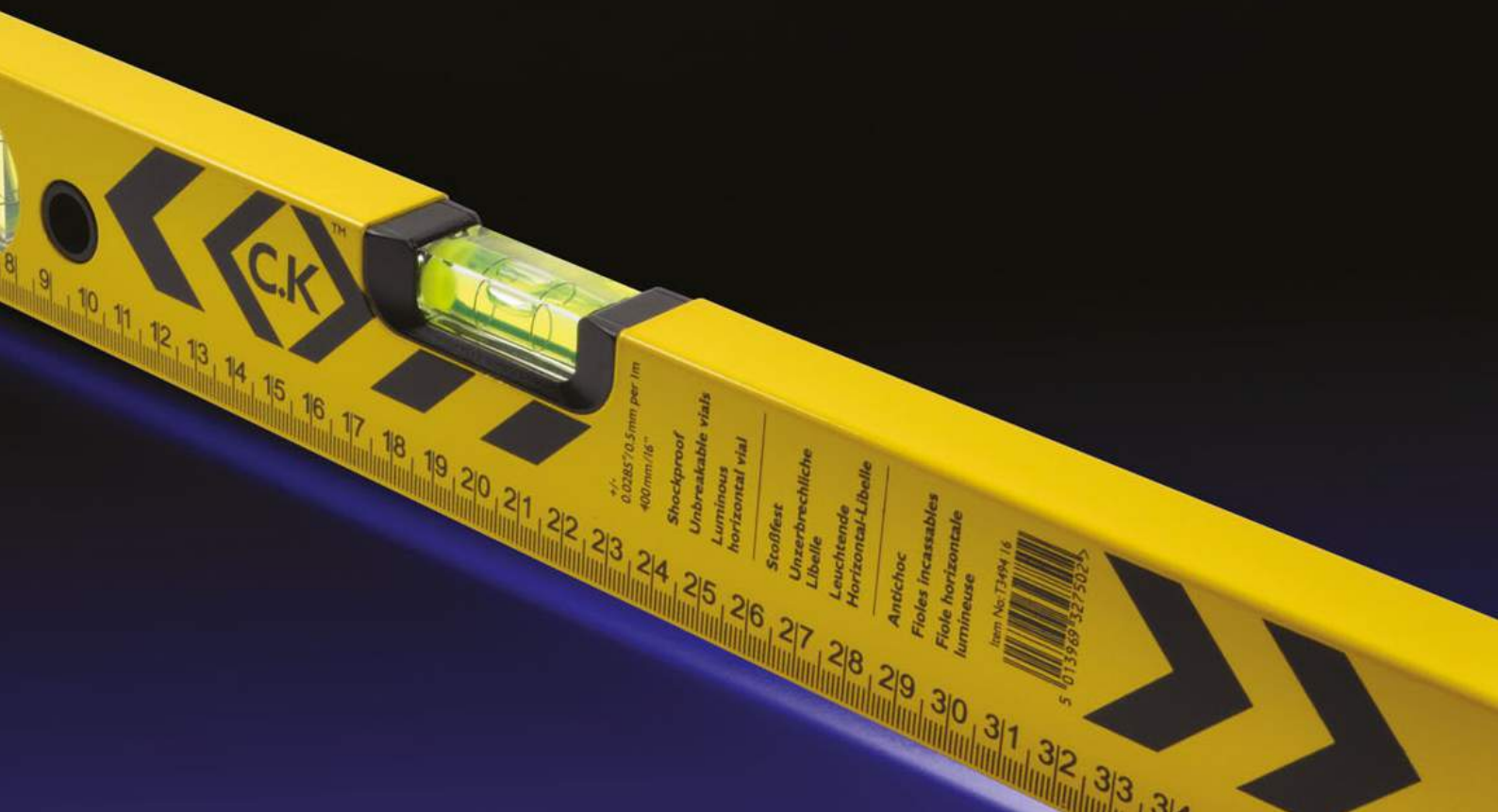



XT & AT TAPES

SOLID, PROFESSIONAL, AFFORDABLE

Professional quality tape measures featuring advanced tape technology to cater for the most demanding requirements.

- 1 Nylon coated blade for superior wear resistance
- 2 Rubber casing for a strong grip and impact protection
- 3 Double sided blade markings for regular, overhead and vertical measuring

XT tape - Manual blade lock, powerful, non-slip.

AT tape - Automatic blade locking mechanism.





TAPE MEASURES



XT Tape Measures

Heavy duty, impact resistant rubber casing. Nylon coated blade. Double sided blade markings – for overhead & vertical measuring. Manual non-slip blade lock. Express blade brake. Dual function end hook. Shock absorbing device at blade retraction hole. Metal belt clip.

2004/22/EC Class 2

Item Number	↔	i	📏	🔒	📦
T3448 16	5m (16ft)	2.3m Blade stand out	305g	25mm	6
T3448 25	7.5m (25ft)	2.8m Blade stand out	470g	27mm	6



AT Tape Measure

Impact resistant robust rubber casing. Double sided blade markings – for overhead & vertical measuring. Shock absorbing device at the blade retraction hole. Metal belt clip. Automatic blade locking mechanism – instant, powerful & non-slip. Easy release blade brake.

2004/22/EC Class 2

Item Number	↔	i	📏	🔒	📦
T3447 16	5m (16ft)	2.3m Blade stand out	285g	25mm	6



ST Tape Measures

Tough ABS plastic body. Full lock & pause buttons. Belt clip. Nylon™ coated blade. 16" & 400mm joist centre markings for fast marking out. True zero hook for accurate external & internal measurements. Integral recoil damper for hook damage protection.

2004/22/EC Class 2

Item Number	↔	i	📦
T3442 10	3m (10ft)	Metric/imperial	6
T3442 16	5m (16ft)	Metric/imperial	6
T3442 25	7.5m (25ft)	Metric/imperial	6
T3442M 3	3m	Metric	6
T3442M 5	5m	Metric	6
T3442M 8	8m	Metric	6



Measuring Tape - Fibreglass

Tough ABS plastic body. Fold out blade hook for secure anchoring. Hand strap for convenient carrying. Fold out winding handle for rapid rewind & safe storage. Glassfibre reinforced tape - strong & stretch resistant. Double sided Metric/Imperial.

2004/22/EC Class 3

Item Number	↔	↑	📦
T3561 100	30m (100ft)	13mm (1/2")	3



Measuring Tape - Steel

Tough steel case. Fold out blade hook for secure anchoring. Hand strap for convenient carrying. Fold out winding handle for rapid rewind & safe storage. Nylon coated steel tape - extremely strong & stretch resistant. Double sided Metric/Imperial.

2004/22/EC Class 3

Item Number	←→	↑	📦
T3563 100	30m (100ft)	13mm (1/2")	3



Surveyor's Tapes

Tough ABS plastic body. Integral ground spike & fold out blade hook for secure anchoring. Soft grip handle. Fold out winding handle for rapid rewind & safe storage. Glassfibre reinforced tape - strong & stretch resistant. Double sided Metric/Imperial.

2004/22/EC Class 3

Item Number	←→	↑	📦
T3565 100	30m (100ft)	13mm (1/2")	3
T3565 165	50m (165ft)	13mm (1/2")	3
T3565 330	100m (330ft)	13mm (1/2")	3

RULES



Steel Rules - Metric/Imperial

Stainless steel for corrosion protection. Permanent indented markings for wear resistance. Fine graduations for accurate measurements.

Item Number	←→	↑	📦
T3530 06	150mm (6")	18mm	6
T3530 12	300mm (12")	25mm	6



Wooden Rule - Metric/Imperial

High quality construction with brass hinges & end caps for durability. Four fold design for compact storage. Permanent indented markings for wear resistance.

Item Number	←→	📦
T3510	1m (3ft)	6



Straight Edge/Rule

Anodised aluminium construction with a strong plastic handle - lightweight, easy clean. Metric graduations. Ideal for cutting, measuring and marking out.

Item Number	←→	📦
T3531 100	1000mm (40")	1

SPIRIT LEVELS



Aluminium Box Levels

Powder coated, box section aluminium - strong, light & durable. Shockproof, unbreakable vials, guaranteed leakproof for three years. Luminous horizontal vial for low light conditions. Precision manufactured, accurate to +/- 0.5mm per metre. Metric measurement graduations for convenience. 16" (400mm) & 24" (600mm) feature 1 vertical & 1 horizontal vial. 32" (800mm) and above feature 2 vertical & 1 horizontal vials.

Item Number	↔	i	📦
T3494 16	400mm (16")	2 vial with rule	3
T3494 24	600mm (24")	2 vial with rule	3
T3494 32	800mm (32")	3 vial with rule	3
T3494 40	1000mm (40")	3 vial with rule	3
T3494 48	1200mm (48")	3 vial	3
T3494 70	1800mm (70")	3 vial	3



Pocket Level

Tough ABS plastic body. V-groove base for pipework. Magnetic base for steelwork. Patented detachable mini level with magnetic base, ideal for setting patress boxes. Also features string slots for use as line level. 1 vertical & 1 horizontal vial.

Item Number	↔	📦
T3482	210mm (8 1/4")	5

CHALK, LINES & ACCESSORIES



Heavy Duty Chalk Line Reel & Chalk

Black lacquered, die cast aluminium case. Fold away winding handle. Push button fast reel out without handle spin for speed. Hardened line hook with bent tips for convenient attachment. Self chalking line. 45 and 90 degree angle markings. Complete with 60g of chalk.

Item Number	↔	📦
T3520B	30m (100ft)	6



Chalk Line Reel & Chalk

Tough plastic construction - strong & lightweight. Fold away winding handle for convenient storage. Self chalking line with end attachment hook for ease of use. Supplied with 60g of blue chalk.

Item Number	↔	📦
T3522	30m (100ft)	6



Chalk Line - Cotton

Strong & absorbent cotton for effective retention of marking chalk.

Item Number	↔	📦
T3517	18m (60ft)	12

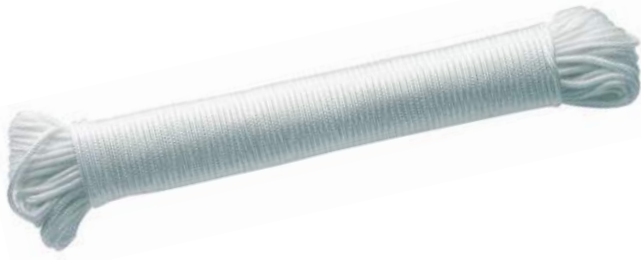

Chalk Line - Nylon

Braided nylon construction - extra strong & durable.

Item Number		
T3519	18m (60ft)	12



Chalk Powders

High density chalk for clear marking results. Plastic refill container with re-sealable dispenser cap.

Item Number			
T3521B 100	100g (4oz)	Blue	6
T3521R 100	100g (4oz)	Red	6



Line Pins

Forged steel nickel plated for strength & corrosion resistance. Suitable for use in wet & dry mortar.

Item Number			
T3490	170mm (6 1/2")	Set of 2	10



Plumb Bob

Conical & fully polished bob. Complete with screwed brass cord fitting.

Item Number		
T3492 11	300g (11oz)	3

JOINERS SQUARES & BEVELS



Joiner's Squares - Rosewood

Hardened & tempered blued steel blade for corrosion resistance. Blade secured with three brass rivets & brass inside face for long term accuracy. Hard rosewood stock.

Item Number		
T3540 09	225mm (9")	3
T3540 12	300mm (12")	3



Sliding Bevel - Rosewood

Hardened & tempered blued steel blade for corrosion resistance. Quick lock lever for convenient adjustment. Hard rosewood stock.

Item Number		
T3541 9	225mm (9")	4



Marking & Mortice Gauge - Rosewood

Screw pin adjustment for accurate & consistent setting of mortice & tenon joints. Heavy brass inlays on marking faces for protection. Hard rosewood body.

Item Number	↔	📦
T3543	190mm (7 1/2")	1



Marking Gauge - Beech

Thumbscrew adjustment for accurate & consistent marking. Brass inlays on marking faces for protection. Beechwood body.

Item Number	↔	📦
T3542A	240mm (9 1/2")	3



Joiners Square - Beech

Hardened & tempered blue steel blade for corrosion resistance. Blade secured with three brass rivets & brass inside face for long term accuracy. Beech stock.

Item Number	↔	📦
T3533 09	225mm (9")	3



Carpenter's Pencil

Traditional rectangular leaded carpenters pencil.

Item Number	📦
T1125 24	25



Sliding Bevel - Beech

Hardened & tempered blue steel blade for corrosion resistance. Beechwood stock.

Item Number	↔	📦
T3537 09	230mm (9")	3

COMBINATION SQUARES

- Stainless steel rule for corrosion protection
- Permanent indented markings for wear resistance



Combination Square - 3 in 1

Heavy duty, 3 in 1 construction for a complete marking & measuring solution.

Item Number			
T3579	300mm (12")	Metric/Imperial	1



Combination Square - Heavy Duty

Heavy duty construction for strength & durability.

Item Number			
T3581	300mm (12")	Metric/Imperial	3



Combination Square

Item Number			
T3582	210mm (8 1/4")		3

VERNIER CALIPERS



Vernier Caliper

Roller adjustment along metric & imperial graduated rule for convenience. Nickel plated for corrosion protection.

Item Number		
T3451	125mm (5")	6

FEELER GAUGES



Feeler Gauges

Blades permanently etched with its size for long term use.

CONTENTS (T3525 413):

Imperial blades, sizes: 2, 3, 4, 5, 6, 8, 10, 12, 15, 20, 25, 30 & 35 thousandths of an inch.

CONTENTS (T3525M 413):

Metric blades, sizes: 0.05, 0.10, 0.15, 0.20, 0.25, 0.30, 0.40, 0.50, 0.60, 0.70, 0.80, 0.90 & 1.00mm.

Item Number			
T3525 413	100mm (4")	Imperial	3
T3525M 413	100mm (4")	Metric	3

POCKET BALANCES



Pocket Balances

Brassed scale, black lacquered body, tinned hook & ring for corrosion resistance. Calibrated in 1lb/0.5Kg divisions.

Item Number		
T6202 025	12.5kg (25lb)	12
T6202 032	15kg (32lb)	12
T6202 044	20kg (44lb)	12
T6202 050	23kg (50lb)	6
T6202 066	30kg (66lb)	6
T6202 088	40kg (88lb)	6
T6202 112	50kg (112lb)	6

C.K ALUMINIUM BOX LEVELS

The range of C.K professional quality levels is manufactured from powder coated box section aluminium. It features virtually unbreakable vials and is guaranteed to be leakproof for a minimum of three years. It also features a luminous horizontal vial for working in low light conditions.

See page 91



WOOD SAWS

98-100

PLASTERBOARD SAWS

100

HACKSAWS

101-102

TRIMMING KNIVES

103-106

WOOD CHISELS

106



SAWING & CUTTING





SABRETOOTH TRADE SAW

THE SAW THAT ROARS

The new Sabretooth Trade saw offers the comfort, speed and durability typically only associated with premium priced saws.

Featuring triple ground 'turbo cut' hard point teeth for effective cutting of timber, chipboard, plywood and plastics.

- 1 Triple ground teeth for improved cutting performance
- 2 Stay sharp hardpoint teeth for an extended working life
- 3 Premium grade steel - rigid, 0.85mm SK5 blade for maximum power transfer
- 4 Universal tooth pitch for cutting a wide range of materials.
- 5 Offset teeth for reduced friction and greater waste removal
- 6 Dual component cushion grip handle for comfort and control
- 7 45 and 90° angle guides for ease of marking out



 **SABRETOOTH**
TRADE
THE SAW THAT ROARS



WOOD SAWS



Sabretooth Trade Saws Universal

Supplied in a counter box when ordered in 10s.

Item Number	↔	tpi	📦
T0840 20	20"	7 TPI / 8 PPI	10
T0840 22	22"	7 TPI / 8 PPI	10



Sabretooth Wood Saws

High performance wood saws. Triple edge, precision ground teeth specially designed to offer an easy start & outstanding cutting performance on both the push & pull stroke. Induction hardened teeth for longer lasting sharpness. Rigid 1mm special alloy steel blade prevents whip & snagging. Ergonomic two component cushion grip handle with finger index for superior comfort & control.

Item Number	↔	tpi	📦
481001	22"	7 TPI / 8 PPI first fix	10
481002	22"	11 TPI / 12 PPI second fix	10



Sabretooth Trade Saw Fine Cut

Supplied in a counter box when ordered in 10s.

Item Number	↔	tpi	📦
T0940 22	22"	9 TPI / 10 PPI	10



Sabretooth Wood Saws Display

CONTENTS:

10 x Sabretooth wood saws.

Item Number	↔	tpi	📦
581001	22"	7 TPI / 8 PPI first fix	1
581002	22"	11 TPI / 12 PPI second fix	1



Sabretooth Wood Saws Dump Bin

CONTENTS:

50 x Sabretooth wood saws.

Item Number		
M8400		1

PLASTERBOARD SAWS



Sabretooth Plasterboard Saw

Item Number		
T0832	150mm (6")	6



Plasterboard Saw

Induction hardened coarse ground cutting teeth & pointed blade for fast cutting of holes in plasterboard for sockets & conduits.

Item Number		
T0831	150mm (6")	6



SABRETOOTH PLASTERBOARD SAW

- 1 For fast cutting of plasterboard, wood and plastic
- 2 Supplied with a protective tooth guard for safe storage
- 3 Triple ground 'turbo cut' teeth for improved cutting performance
- 4 Rigid 1.5mm premium grade SK5 steel blade
- 5 Cushion grip handle with anti-slip horns for increased comfort, control and safety



HACKSAWS



Hacksaw - Quick Change

Heavy duty premium quality hacksaw with rubber grips for comfort & control. Quick release blade change mechanism for convenience. High leverage blade tensioning system for straighter cuts. Spare blade storage in back frame for convenience. 45 & 90° blade positions.

Item Number		tpi	
T0814	300mm (12")	24	3



Hacksaw - Heavy Duty

Heavy duty, box section steel frame with aluminium handle for strength & durability. High leverage blade tensioning system for straighter cuts. Spare blade storage in back frame for convenience. 45 & 90° blade positions.

Item Number		tpi	
T0905	300mm (12")	24	3



Hacksaw Blades

Shatterproof HSS Bi-metal construction.

Item Number		tpi		
T0932R 1218	300mm (12")	18	Pack of 3	1
T0931R 12	300mm (12")	24	Pack of 3	12
T0934R 1232	300mm (12")	32	Pack of 3	1
T0932 12	300mm (12")	18	Pack of 25	1
T0933 12	300mm (12")	24	Pack of 25	1
T0934 12	300mm (12")	32	Pack of 25	1



Hacksaw Blades Display

CONTENTS:

18 x hacksaw blades, sizes: 18, 24 & 32 tpi.

Item Number		
T0930RBOM	Stock, stand & header	1



Mini Saw

Ideal for flush cutting and cutting in confined spaces. Robust, die cast aluminium handle - strong & lightweight. Complete with HSS bi-metal blade. Fast and easy blade fitting with large screw clamp.

Item Number	↔	📦
T0833	300mm (12")	12



Junior Hacksaw

Non protruding blade fixing for safety.

Item Number	↔	📦
T0834	150mm (6")	6



Mini Hacksaw

Cast aluminium frame for strength. Broad handle for comfort. Adjustable blade for angled cutting. Special screw tensioner for fast & simple blade fitting.

Item Number	↔	📦
T0836A	150mm (6")	6



Junior Hacksaw Blades

Pack of 10 blades.

Item Number	↔	i	📦
T0835	150mm (6")	x 10	5



Mini Hacksaw & Mitre Box

Cast aluminium frame for strength. Broad handle for comfort. Adjustable blade for angled cutting. Special screw tensioner for fast & simple blade fitting. Supplied with lightweight 3 angle mitre box.

Item Number	↔	📦
T0837	300mm (12")	5

TRIMMING KNIVES



Soft Grip Trimming Knife - Retracting

Fully featured trimming knife - see previous page for details. Complete pack of 10 spare blades.

Item Number	
T0957-1	6



Soft Grip Trimming Knife - Non Retractable

Ergonomically designed, soft grip handle for increased comfort & control. Robust, die cast aluminium housing both strong and lightweight. Safety interlocking joint to prevent the blade slipping through the body joint. Magnetic blade retainer & captive body screw for quick & easy blade changes. Internal 5 blade storage compartment. Complete pack of 10 spare blades.

Item Number	
T0957-2	6



Trimming Knife - Retractable

Robust, die cast aluminium housing both strong and lightweight. Safety interlocking joint to prevent the blade slipping through the body joint. Magnetic blade retainer & captive body screw for quick & easy blade changes. Retractable blade for safe storage. String/wire cutting notch for convenience. Internal 5 blade storage compartment. Complete pack of 10 spare blades.

Item Number	
T0956-1	6



Trimming Knife - Non Retractable

Robust, die cast aluminium housing both strong and lightweight. Safety interlocking joint to prevent the blade slipping through the body joint. Magnetic blade retainer & captive body screw for quick & easy blade changes. Internal 5 blade storage compartment. Complete pack of 10 spare blades.

Item Number	
T0956-2	6



Trimming Knife - Auto Retracting

Auto retracting blade for safety in use & storage. Robust, die cast aluminium housing both strong and lightweight. Safety interlocking joint to prevent the blade slipping through the body joint. Complete pack of 10 spare blades.

Item Number	
T0969	6





TWIN BLADE FOLDING UTILITY KNIFE

COMBINED UTILITY AND SOLID BLADE KNIFE



- 1 Precision engineered, stainless steel blade holder reduces blade wobble during straight line cuts
- 2 Easy fit blade holder mechanism enables blade changes in under 3 seconds
- 3 Ergonomic, anodised aluminium handle, strong, lightweight and comfortable in use
- 4 Quick release, push button locking mechanism for single handed operation
- 5 Thumb ledge for greater control and firmer cutting action



Twin Blade Folding Utility Knife

Combined utility and solid blade knife for convenience. Precision engineered, stainless steel blade holder reduces blade wobble during straight line cuts.* Easy fit blade holder mechanism enables blade changes in under 3 seconds.* Ergonomic, anodised aluminium handle, strong, lightweight & comfortable in use. Quick release, push button locking mechanism for single handed operation. Thumb ledge for greater control and firmer cutting action.*

*Applies to utility knife only.

Item Number



T0955

6



Folding Utility Knife

Ergonomic, anodised aluminium handle, strong, lightweight & comfortable in use. Precision engineered, stainless steel blade holder reduces blade wobble during straight line cuts. Quick release push button safety locking mechanism for single handed operation. Easy fit blade holder mechanism for single handed operation. Thumb ledge for greater control and firmer cutting action.

Item Number



T0954

6



Folding Utility Knife - Counterbox of 10

Contents: 10 x T0954.

Item Number	
T0954CBOX	1



Spare Blades - Standard

Heavy duty blades supplied in a spring loaded blade dispenser for safety & convenient storage.

Item Number		
T0959-10	x 10	12
T0959-50	x 50	12
T0959-100	x 100	12



Trimming Knife - Snap Off Blade

Heavy duty plastic body with soft grip handle for comfort & control. Push button blade positioning with locking system for control & safety. Integrated blade snapper for safe blade segment removal. Supplied with 4 blades stored in the handle for convenience.

Item Number	
T0958	12



Spare Blades - Snap Off

Heavy duty segmented blades supplied in a spring loaded blade dispenser for safety & convenient storage.

Item Number		
T0971-10	x 10	12



Die-Cast 9mm Snap-Off Trimming Knife

Die-cast, zinc alloy body with anti-slip handle grips. Retractable blade with push-button positioning for control and safety. Integrated blade snapper. Hanging hole for storage. Pack of 10 spare blades also available (Item No. T0953-10).

Item Number		
T0952	Supplied with one blade. Spare blades available: Item No. T0953-10	12



9mm Snap-Off Trimming Knife

Lightweight and tough ABS handle grips. Stainless steel body with internal storage for up to two spare blades. Integrated blade snapper and pocket-clip. Retractable blade with push-button positioning for control and safety. Pack of 10 spare blades also available (Item No. T0953-10).

Item Number		
T0951	Supplied with one blade. Spare blades available: Item No. T0953-10	12

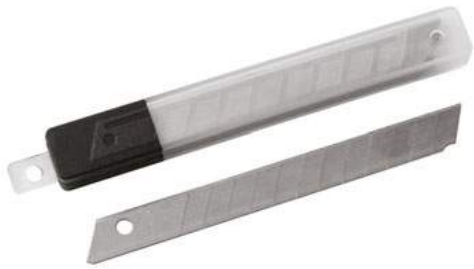

9mm Snap-Off Trimming Knife Blades

Pack contains 10 x 9mm blades. 12 segments per blade. Razor sharp blades - handle with care.

Item Number		
T0953-10	Compatible with the following C.K Trimming Knives: T0951, T0952	25



Wood Chisels & Sharpening Stone Set

Supplied with silicone carbide sharpening stone & protective storage case.

CONTENTS:

1 x wood chisel, sizes: 6, 13, 19, & 25mm and sharpening stone.

Item Number		
T1180	5 piece set	3

WOOD CHISELS



Wood Chisels

Finest chrome vanadium steel, full length hardened & tempered for long life performance. Shatterproof acetate handle for safety. Replaceable blade cover for protection & safety.

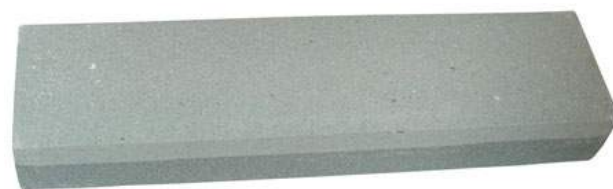

Sharpening Stone

Double sided medium/fine silicon carbide sharpening stone, ideal for sharpening chisels, scissors, shears, etc.

Item Number		
T1126	200 x 50mm	1

Item Number		
T1178 025	6mm (1/4")	3
T1178 037	10mm (3/8")	3
T1178 050	13mm (1/2")	3
T1178 062	16mm (5/8")	3
T1178 075	19mm (3/4")	3
T1178 087	22mm (7/8")	3
T1178 100	25mm (1")	3
T1178 125	32mm (1 1/4")	3
T1178 150	38mm (1 1/2")	3



Bevel Edge Chisel - Stocked Stand

CONTENTS:

3 x wood chisels, sizes: 6, 10, 13, 16, 19, 22, 25, 32 & 38mm and sharpening stone.

Item Number		
T1178LS	Stock & stand	1

 **SABRETOOTH**
TRADE

THE SAW THAT ROARS



Sabretooth Trade saws offer advanced cutting performance and an extended working life.

- **SPEED:** Triple Ground 'Turbo Cut' hard-point teeth
- **DURABILITY:** Premium grade SK5 alloy steel
- **COMFORT:** Dual component, cushion grip handle



designed for professionals

See pages 98-99

**SURE-DRIVE SOCKET
& ACCESSORIES**

110-113

SURE DRIVE SOCKET SETS

113

SPANNERS

114-115

WRENCHES

115-116

HEXAGON KEYS

117-118



SOCKETS, SPANNERS & WRENCHES

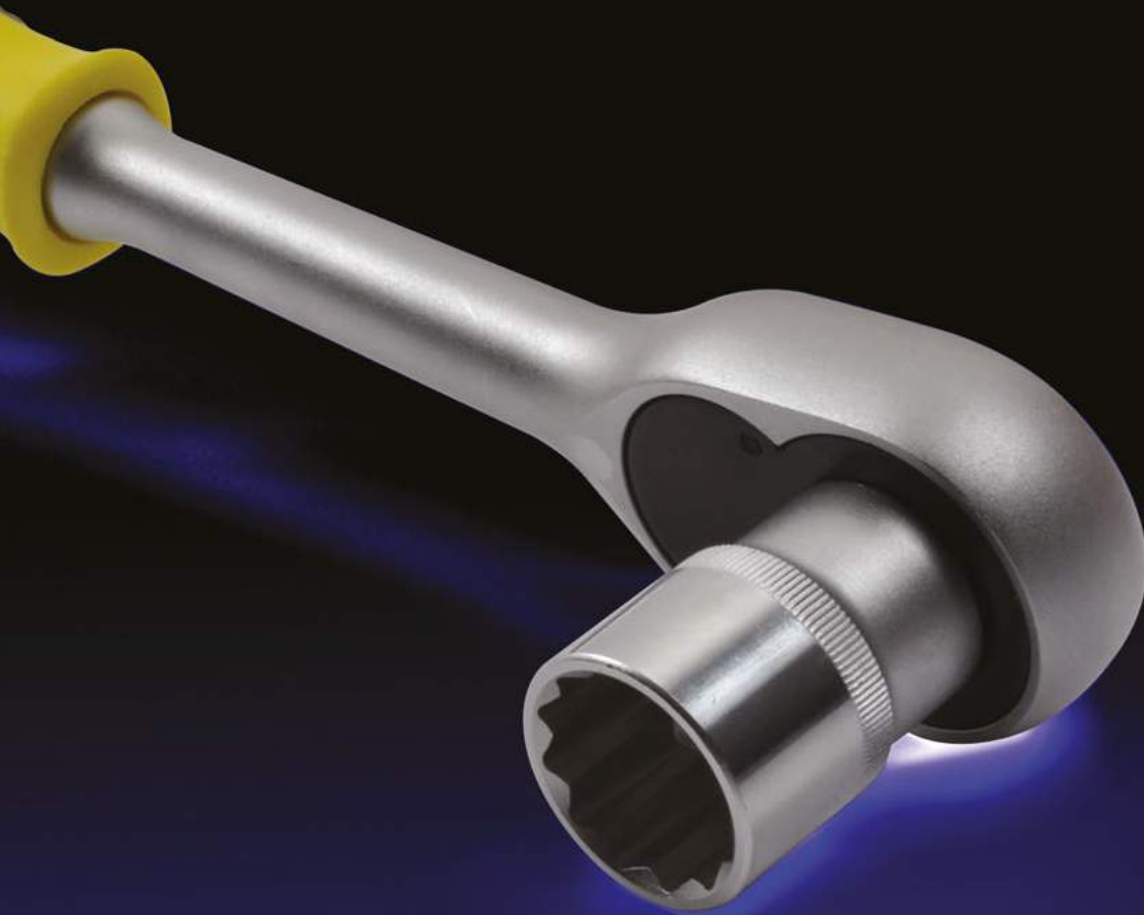
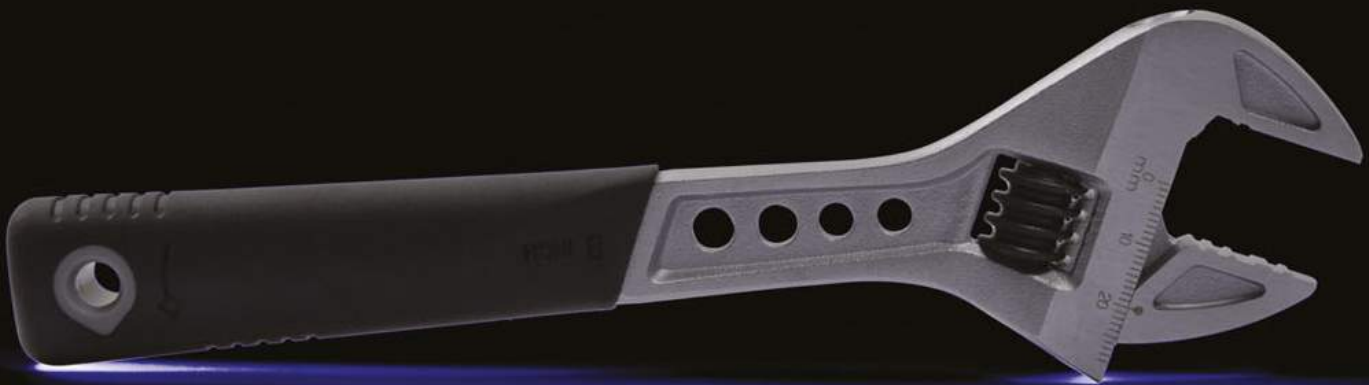



SURE-DRIVE

RATCHET HANDLE

- 1 Heavy duty chrome vanadium construction for superior strength and durability
- 2 Reversible, 45 tooth ratchet mechanism for a finer working arc (8° arc)
- 3 Ball bearing locking system with push button release mechanism for quick inter-change of sockets
- 4 Dual component, non slip grip for added comfort & control

SOCKETS

- 5 Forged Chrome Vanadium steel for superior strength and durability
- 6 Non slip, satin chrome plated for resistance to rust and peeling
- 7 C.K. 'Sure-drive' system applies torque to the flat of the nut rather than the corners to avoid rounding off





SURE-DRIVE SOCKETS & ACCESSORIES



Sockets - 1/2" Drive Metric

Item Number	↔	📦
T4690M 10	10mm	5
T4690M 11	11mm	5
T4690M 12	12mm	5
T4690M 13	13mm	5
T4690M 14	14mm	5
T4690M 15	15mm	5
T4690M 16	16mm	5
T4690M 17	17mm	5
T4690M 18	18mm	5
T4690M 19	19mm	5
T4690M 20	20mm	5
T4690M 21	21mm	5
T4690M 22	22mm	5
T4690M 23	23mm	5
T4690M 24	24mm	5
T4690M 27	27mm	5
T4690M 30	30mm	5
T4690M 32	32mm	5



Torque Wrench - 1/2" Drive

Heavy duty chrome vanadium construction for superior strength and durability. Micrometer sleeve for accurate torque setting. Individually calibrated and supplied with a certificate of calibration. Supplied in a protective storage case complete with 120mm extension drive & 3/8" square drive adapter.

DIN 3122

Item Number	↔	📦
T4463	600mm 18"	12



Sockets Display Stand

CONTENTS:

3 x sockets, sizes: 10, 11, 12, 13, 14, 15, 16, 17, 18, 19, 20 & 21.
2 x sockets size: 22, 23, 24, 27, 30 & 32mm.

Item Number	📦
T4644RBOM	1



Ratchet Handle - 1/2" Drive 45 Teeth

Heavy duty chrome vanadium construction. Reversible 45 tooth ratchet mechanism (80 working arc). Push button socket release mechanism. Dual component non slip grip.

Item Number	📦
T4691	5



Flexible Handle - 1/2" Drive

Heavy duty chrome vanadium construction. Pivoted drive for angled access in tight spaces. Dual component non slip grip.

Item Number	↔	📦
T4692	430mm (17")	5



Ratchet Handle - 1/2" Drive 24 Teeth

Reversible, 24 tooth ratchet mechanism for high torque applications. Heavy duty chrome vanadium construction for superior strength & durability. Ball bearing locking system with push button release mechanism for quick inter-change of sockets.

Item Number		
T4603		3



Ratchet Handle - 1/2" Drive 24 Teeth - Repair Kit

Contains all the components required to fully refurbish the T4603 ratchet drive assembly.

Item Number		
T4603 1		1



Sliding T-Handle - 1/2" Drive

Heavy duty chrome vanadium construction for superior strength & durability.

Item Number		
T4695	250mm (10")	5



Long Extension - 1/2" Drive

Heavy duty chrome vanadium construction for superior strength & durability.

Item Number		
T4693	250mm (10")	5



Short Extension - 1/2" Drive

Heavy duty chrome vanadium construction for superior strength & durability.

Item Number		
T4694	125mm (5")	5



Universal Joint - 1/2" Drive

Heavy duty chrome vanadium construction for superior strength and durability.

Item Number		
T4696		5



Socket Accessory Bar - 1/2" Drive

CONTENTS:
3 x ratchet handle, 3 x sliding t-handle, 3 x flexible handle, 3 x long extension, 3 x short extension and 3 x universal joint.

Item Number		
T4645RBOM	Stock, stand & header	1



Socket Set - 23 Piece 3/8" Drive Metric

CONTENTS:
45 tooth ratchet handle, 1 x socket sizes 6, 7, 8, 9, 10, 11, 12, 13, 14, 15, 16, 17, 18, 19, 20, 21, 22 & 24mm, Long extension, Short extension, Universal joint and 1/2" drive adaptor/t-handle adaptor.

Item Number	
T4656	10

SURE-DRIVE SOCKET SETS



Socket Set - 22 Piece 1/2" Drive Metric

CONTENTS:
45 tooth ratchet handle, 1 x socket, sizes: 10, 11, 12, 13, 14, 15, 16, 17, 18, 19, 22, 24, 27, 30 & 32mm, 1 x long reach socket sizes 16 & 21mm, Long extension, Short extension, Universal joint and 3/8" drive adaptor/t-handle adaptor.

Item Number	
T4657	1



Socket Set - 39 Piece 1/4" Drive Metric

CONTENTS:
45 tooth ratchet handle, 1 x socket sizes: 4, 4.5, 5, 5.5, 6, 7, 8, 9, 10, 11, 12, 13 & 14mm, 1 x hexagon socket bit sizes 3, 4, 5 & 6mm, 1 x tamperproof TX socket bit sizes 8, 10, 15, 20, 25, 27, 30 & 40, 1 x socket bits slotted sizes 4, 5.5 & 7mm, PZ sizes 1, 2 & 3, PH sizes 1, 2 & 3, Short extension, 1/4" drive handle, Universal joint and Hex to 1/4" drive adaptor.

Item Number	
T4655	10

SPANNERS



Combination Spanners - Metric

Drop forged chrome vanadium steel, hardened & tempered for strength & durability. Heavy duty chrome plated for corrosion resistance. 12° offset bi-hex ring for access.

DIN 3113

Item Number	Spanner Length	Hex Size	Access	Quantity
T4343M 06	100mm	6mm	Loose	10
T4343M 06H	100mm	6mm	On hanger	6
T4343M 07	110mm	7mm	Loose	10
T4343M 07H	110mm	7mm	On hanger	6
T4343M 08	120mm	8mm	Loose	10
T4343M 08H	120mm	8mm	On hanger	6
T4343M 09	130mm	9mm	Loose	10
T4343M 09H	130mm	9mm	On hanger	6
T4343M 10	140mm	10mm	Loose	10
T4343M 10H	140mm	10mm	On hanger	3
T4343M 11	150mm	11mm	Loose	10
T4343M 11H	150mm	11mm	On hanger	3
T4343M 12	160mm	12mm	Loose	10
T4343M 12H	160mm	12mm	On hanger	3
T4343M 13	170mm	13mm	Loose	10
T4343M 13H	170mm	13mm	On hanger	3
T4343M 14	180mm	14mm	Loose	10
T4343M 14H	180mm	14mm	On hanger	6
T4343M 15	190mm	15mm	Loose	10
T4343M 15H	190mm	15mm	On hanger	6
T4343M 16	200mm	16mm	Loose	10
T4343M 16H	200mm	16mm	On hanger	6
T4343M 17	210mm	17mm	Loose	10
T4343M 17H	210mm	17mm	On hanger	3
T4343M 18	220mm	18mm	Loose	10
T4343M 18H	220mm	18mm	On hanger	1
T4343M 19	230mm	19mm	Loose	10
T4343M 19H	230mm	19mm	On hanger	1
T4343M 20	240mm	20mm	Loose	5
T4343M 20H	240mm	20mm	On hanger	1
T4343M 21	250mm	21mm	Loose	5
T4343M 21H	250mm	21mm	On hanger	1
T4343M 22	260mm	22mm	Loose	5
T4343M 22H	260mm	22mm	On hanger	1
T4343M 24	280mm	24mm	Loose	5
T4343M 24H	280mm	24mm	On hanger	1
T4343M 27	310mm	27mm	Loose	5
T4343M 27H	310mm	27mm	On hanger	1
T4343M 30	340mm	30mm	Loose	5
T4343M 30H	340mm	30mm	On hanger	1
T4343M 32	360mm	32mm	Loose	5
T4343M 32H	360mm	32mm	On hanger	1



Combination Spanners Set - 10 Piece Metric

Supplied in a wall mounting rack for convenient storage.

CONTENTS:

1 x combination spanner, sizes: 8, 9, 10, 11, 12, 13, 14, 15, 17, & 19mm.

DIN3113

Item Number	Quantity
T4343M/10ST	3



Combination Spanners Set - 12 Piece Metric

Supplied in a wall mounting rack for convenient storage.

CONTENTS:

1 x combination spanner, sizes: 8, 9, 10, 11, 12, 13, 14, 15, 17, 19, 21 & 22mm.

DIN 3113

Item Number	Quantity
T4343M/12ST	1



Combination Spanner Display

CONTENTS:

2 x combination spanners, sizes: 6, 7, 8, 9, 10, 11, 12, 13, 14, 15, 16, 17, 18, 19, 20, 21, 22 & 24mm and 1 x combination spanners, sizes: 27, 30 & 32mm.

Item Number		
T4343MRBOM	Stock & stand	1



Speed Spanners Set - 6 Piece Metric

Drop forged chrome vanadium steel, hardened & tempered for strength & durability. Colour coded for quick selection of the correct size. Innovative ratchet action style jaw. 12° offset bi-hex ring for access. Supplied in a wall mounting rack.

CONTENTS:

1 x combination spanner, sizes: 10, 12, 13, 14, 15 & 17mm

Item Number	
T4345/6ST	5

WRENCHES



Adjustable Wrench - Sure Drive

Sure-drive jaws which apply torque to the flat of the nut rather than the corners to avoid rounding off.

Extra capacity jaws - up to 18% wider than standard patterns.

Item Number			
T4365 150	150mm (6")	24mm	3
T4365 200	200mm (8")	29mm	3
T4365 250	250mm (10")	33mm	3
T4365 300	300mm (12")	38mm	3



Adjustable Wrenches - Wide Jaw

Extra capacity jaws - up to 26% wider than standard patterns.

Item Number			
T4366 150	150mm (6")	24mm	6
T4366 200	200mm (8")	29mm	6
T4366 250	250mm (10")	33mm	6
T4366 300	300mm (12")	38mm	6
T4366 375	375mm (15")	51mm	5
T4366 450	450mm (18")	60mm	5



Adjustable Wrenches - Standard

Chrome plated for corrosion resistance.

Item Number	↔	👉	📦
T4368 150	150mm (6")	19mm	6
T4368 200	200mm (8")	24mm	6
T4368 250	250mm (10")	29mm	6
T4368 300	300mm (12")	34mm	6



Self Grip Wrenches - Straight Jaws

Drop forged and hardened chrome vanadium jaws for strength and durability. Flat jaws ideal for gripping flat surfaces up to 40mm thick. Fine opening adjustment. Quick release lever. Epoxy coated for corrosion protection.

Item Number	↔	👉	📦
T3641	250mm (10")	40mm	3



Self Grip Wrenches - Concave Jaws

Drop forged and hardened chrome vanadium jaws for strength and durability. Concave jaws ideal for gripping round materials up to 50mm Diameter. Integral wire cutting blades. Fine opening adjustment. Quick release lever. Epoxy coated for corrosion protection.

Item Number	↔	👉	📦
T3630 10	250mm (10")	50mm	5



Self Grip Wrenches - Straight / Curved Jaws

Drop forged chrome vanadium hardened jaws for strength and durability. Combination straight and curved jaws ideal for gripping round, flat and square sections. Fine opening adjustment. Quick release lever. Epoxy coated for corrosion protection.

Item Number	↔	👉	📦
T3638 07	180mm (7")	25mm	6
T3638 10	250mm (10")	35mm	6



Stillson Wrenches

High quality drop forged steel construction with hardened & tempered jaws for strength & durability. Patented head design for high torque performance. Non slip, durable finish for grip and control.

Item Number	↔	👉	📦
T3735 300	300mm (12")	38mm	8
T3735 350	350mm (14")	55mm	8
T3735 450	450mm (18")	55mm	8
T3735 600	600mm (24")	70mm	4

HEXAGON KEYS

- Chrome vanadium steel, hardened & tempered for strength & durability.



Hexagon Keys - Metric

ISO 2936

Item Number				
T4411 007	0.7mm	32mm	6mm	12
T4411 009	0.9mm	32mm	10mm	12
T4411 01	1.0mm	32mm	10mm	12
T4411 012	1.2mm	38mm	10mm	12
T4411 0127	1.27mm	40mm	12mm	12
T4411 015	1.5mm	45mm	14mm	12
T4411 02	2.0mm	50mm	16mm	12
T4411 025	2.5mm	56mm	18mm	12
T4411 03	3.0mm	63mm	20mm	12
T4411 035	3.5mm	67mm	23mm	12
T4411 04	4.0mm	71mm	25mm	12
T4411 045	4.5mm	75mm	26mm	12
T4411 05	5.0mm	80mm	28mm	12
T4411 055	5.5mm	85mm	30mm	12
T4411 06	6.0mm	90mm	32mm	12
T4411 07	7.0mm	95mm	34mm	12
T4411 08	8.0mm	100mm	36mm	12
T4411 09	9.0mm	105mm	38mm	12
T4411 10	10.0mm	112mm	40mm	12
T4411 11	11.0mm	118mm	43mm	12
T4411 12	12.0mm	125mm	45mm	6
T4411 13	13.0mm	133mm	50mm	6
T4411 14	14.0mm	140mm	56mm	3
T4411 15	15.0mm	147mm	58mm	3
T4411 16	16.0mm	154mm	60mm	3
T4411 17	17.0mm	160mm	63mm	3
T4411 18	18.0mm	170mm	65mm	3
T4411 19	19.0mm	180mm	70mm	3
T4411 20	20.0mm	187mm	73mm	3
T4411 22	22.0mm	200mm	80mm	3



Hexagon Key Folding Sets - 7 Piece

Supplied in a heavy duty nickel plated steel clip holder for convenience.

Item Number		
T4404A	Metric 2.5, 3, 4, 5, 6, 7, 8mm	6
T4405A	Imperial AF 3/32, 5/32, 3/16, 1/4, 5/16, 3/8"	6



TX Tamperproof Key Folding Set - 8 Piece

Supplied in a clip holder for convenience.

Item Number		
T4407	T06, T07, T08, T09, T10, T15, T20, T25	12



Hexagon Key Ring Set - 8 Piece

Supplied on a key ring for convenience.

ISO 2936

Item Number	i	
T4414	Imperial AF 1/16, 5/64, 3/32, 1/8, 5/32, 3/16, 7/32, 1/4"	6
T4417	Metric 1.5, 2, 2.5, 3, 4, 5, 6, 7mm	6



Hexagon Key Clip Set - 10 Piece Ball End

Ball ended for use at an angle of up to 25° where access is restricted. Supplied in a storage holder for convenience.

Item Number	i	
T4443M	Metric 1.5, 2, 2.5, 3, 4, 5, 6, 7, 8, 10mm	6



Hexagon Key Ring Set - 10 Piece

Supplied on a key ring for convenience.

ISO 2936

Item Number	i	
T4415	Imperial AF 1/16, 5/64, 3/32, 1/8, 5/32, 3/16, 7/32, 1/4, 5/16, 3/8"	6
T4416	Metric 1.5, 2, 2.5, 3, 4, 5, 6, 7, 8, 10mm	6



Hexagon Key Clip Set - 9 Piece Ball End

Ball ended for use at an angle of up to 25° where access is restricted. Supplied in a storage holder for convenience.

Item Number	i	
T4444I	Imperial AF 5/64, 3/32, 1/8, 5/32, 3/16, 7/32, 1/4, 5/16, 3/8"	6

SURE-DRIVE SOCKET SET T4655

- 1 High quality chrome vanadium steel
- 2 Non-slip satin chrome finish for maximum resistance
- 3 Push button quick-release ratchet
- 4 Sturdy compact metal box

**QUICK
RELEASE
RATCHET**



See page 113

FILES

122-124

TAPS & DIE SET

129

WARDING & NEEDLE FILES

124-125

WIRE BRUSH

129

HAMMERS

126

PUNCHES

126-127

SNIPS

128

COMPOUND ACTION SNIPS

128

STUD EXTRACTORS

129



ENGINEERS TOOLS



FILES



FILES

1 Manufactured from special file steel, precision cut and hardened for outstanding performance and durability

2 Ergonomic, soft grip handle for superior comfort and control

3 Specially designed solid inner core for a safe and secure handle to tang bond



Engineer's File - Flat Bastard Cut

One safe edge.

Item Number	↔	i	📦
T0080B 10	250mm (10")	Flat Profile	3



Engineer's Files - Flat Second Cut

One safe edge.

Item Number	↔	i	📦
T0080 6	150mm (6")	Flat Profile	3
T0080 8	200mm (8")	Flat Profile	3
T0080 10	250mm (10")	Flat Profile	3



Engineer's Files - Flat Smooth Cut

One safe edge.

Item Number	↔	i	📦
T0080S 6	150mm (6")	Flat Profile	3
T0080S 8	200mm (8")	Flat Profile	3



Engineer's Files - Half Round Second Cut



Tapered towards the point.

Item Number	↔	i	📦
T0082 6	150mm (6")	Half Round Profile	3
T0082 8	200mm (8")	Half Round Profile	3
T0082 10	250mm (10")	Half Round Profile	3



Engineer's Files - Round Second Cut



Tapered towards the point.

Item Number			
T0083 6	150mm (6")	Round Profile	3
T0083 8	200mm (8")	Round Profile	3
T0083 10	250mm (10")	Round Profile	3



Chain Saw Files



Second cut.

Item Number			
T0079 1	175mm (7")	4mm (5/32")	6
T0079 2	175mm (7")	5mm (3/16")	6
T0079 3	175mm (7")	5.5mm (7/32")	6



Combined File & Rasp



1 side bastard rasp. 1 side bastard cut.

Item Number			
T0106 06	150mm (6")	Flat Profile Rasp	3
T0106 08	200mm (8")	Flat Profile Rasp	3



Saw File - Standard



Tapered towards the point.

Item Number			
T0074 6	150mm (6")	Triangular Profile	3



Wood Rasp



Tapered towards the point.

Item Number			
T0107 06	150mm (6")	Half Round Profile	3
T0107 08	200mm (8")	Half Round Profile	3



Saw File - Slim

Tapered towards the point.

Item Number			
T0073 6	150mm (6")	Triangular Profile	3

WARDING & NEEDLE FILES



Saw File - Extra Slim

Tapered towards the point.

Item Number	← →	i	📦
T0072 5	125mm (5")	Triangular Profile	6



Warding File - Flat Second Cut, Square

Item Number	← →	i	📦
T0120 1	100mm (4")	Flat Profile	6



Mill Saw File

Flat profile. Single cut.

Item Number	← →	i	📦
T0075 10	250mm (10")	Flat Profile	3



Warding File - Flat Second Cut, Tapered

Item Number	← →	i	📦
T0120 2	100mm (4")	Flat Profile	6



File Display

CONTENTS:

2 x file/rasp, sizes 150mm & 200mm, 2 x wood rasp, 150mm & 200mm, 2 x chain saw files, sizes: 1, 2, 3, 2 x engineer's files, flat, second cut, 150mm, 200mm & 250mm, 2 x engineer's files, flat, smooth cut, 150mm & 200mm, 2 x engineer's files, half round, second cut, 150mm & 200mm, 2 x engineer's files, round, second cut, 150mm & 200mm, 2 x engineer's files, flat, bastard cut, size: 250mm, 2 x mill saw files, single cut, size: 250mm, 2 x saw files, extra slim, slim & standard.

Item Number	i	📦
T0099LS	Stock, stand & header	1



Warding File - Half Round Second Cut

Item Number	← →	i	📦
T0120 3	100mm (4")	Half Round Rasp Profile	6



Warding File - Round Second Cut

Item Number			
T0120 4	100mm (4")	Round Profile	6



Warding File Set - 6 Piece

Item Number			
T0120P	100mm (4")	Flat, Flat Tapered, Half Round, Round, Square & Triangular Profiles	3



Warding File - Square Second Cut

Item Number			
T0120 5	100mm (4")	Square File	6



Warding File Set - 4 Piece

Item Number			
T0119	100mm (4")	Triangular, Flat, Round & Flat Tapered Profiles	3



Warding File - Triangular Second Cut

Item Number			
T0120 6	100mm (4")	Triangular Profile	6



Needle File Set - 6 Piece



Item Number		
T0124P	Triangular, Flat, Tapered Flat, Half Round & Round Profiles	3

HAMMERS



Ball Pein Hammers



Drop forged high carbon steel head - hardened & tempered for superior strength and durability. Black lacquered to protect against corrosion. Tough hickory shaft for durability. Ball pein for setting rivets.

Item Number		
T4208H 08	227g (1/2lb)	3
T4208H 16	454g (1lb)	3
T4208H 24	682g (1 1/2lb)	3
T4208H 32	908g (2lb)	3



Engineer's Hammers - French Pattern

Drop forged high carbon steel head - hardened & tempered for superior strength and durability. Black lacquered to protect against corrosion. Traditional ash shaft for strength.



Item Number		
356002	300g (10 1/2oz)	12
356003	400g (14oz)	3



Engineer's Hammers - German Pattern

Drop forged high carbon steel head - hardened & tempered for superior strength and durability. Black lacquered to protect against corrosion. Traditional ash shaft for strength.

DIN 1041

Item Number		
T4227A 0100	100g (3 1/2oz)	12
T4227A 0200	200g (7oz)	12
T4227A 0300	300g (10 1/2oz)	12
T4227A 0500	500g (17 1/2oz)	12
T4227A 1000	1000g (35oz)	6

PUNCHES



Centre Punch - Round 10mm

Hardened carbon steel with gun metal finish for protection. Knurled shaft for grip.

Item Number		
T3307P	100mm (4")	12



Centre Punch - Octagonal 10mm

High quality chrome vanadium steel hardened for durability.

Item Number		
T3319	150mm (6")	6



Centre Punch - Octagonal 12mm

High quality chrome vanadium steel hardened for durability.

Item Number		
T3326	120mm (4 3/4")	6



Parallel Pin Punches

High quality chrome molybdenum steel hardened for durability.

DIN 6450

Item Number			
T3328 05	150mm (6")	2mm (5/64")	6
T3328 06	150mm (6")	2.5mm (3/32")	6
T3328 08	150mm (6")	3mm (1/8")	6
T3328 10	150mm (6")	4mm (5/32")	6
T3328 12	150mm (6")	5mm (3/16")	6
T3328 14	150mm (6")	5.5mm (7/32")	6
T3328 16	150mm (6")	6mm (1/4")	6
T3328 20	150mm (6")	8mm (5/16")	6
T3328 24	150mm (6")	10mm (3/8")	6



Parallel Pin Punch Set - 6 Piece

DIN 6450



Item Number		
T3328S	2, 2.5, 3, 4, 5 & 6mm	3

SNIPS



Tin Snips

Forged alloy steel for strength & durability. Hardened & tempered jaws for high cutting performance. Stop pin to prevent finger nipping during use.

Item Number		
T4536 08	200mm (8")	3
T4536 10	250mm (10")	3



Tuff Snips

Lightweight multi purpose cutter for paper, card, cloth, thin sheet metal etc.



Item Number		
T4506	180mm (7")	6

COMPOUND ACTION SNIPS

- Compound action, high leverage design for easy cutting of steel, stainless steel, titanium, etc.
- Forged chrome molybdenum steel jaws, hardened and tempered for long term cutting performance.
- Ergonomic grips with slip guards for safety.





Compound Action Snips - Straight

Item Number			
T4537AS	240mm (10")	Straight	3





Compound Action Snips - Left

Item Number			
T4537AL	240mm (10")	Left	3



Compound Action Snips - Right

Item Number			
T4537AR	240mm (10")	Right	3

STUD EXTRACTORS



Stud Extractor Set - 5 Piece

Hardened chrome vanadium steel. Left hand threaded for extracting broken studs and screws.

Item Number



T3062 01

5



Stud Extractor Set - 6 Piece

Hardened chrome vanadium steel. Left hand threaded for extracting broken studs and screws.

Item Number



T3062 02

5

TAPS & DIE SET

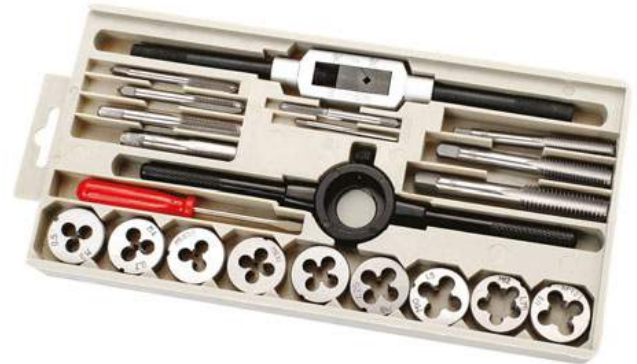

Tap & Die Set - 21 Piece Metric

High carbon steel, hardened & tempered for strength and durability. Precision machined to produce accurate thread forms.

CONTENTS:

Tap & dies, sizes: 3 x 0.5, 4 x 0.7, 5 x 0.8, 6 x 1.0, 7 x 1.0, 8 x 1.25, 10 x 1.5, 12 x 1.75mm & 1/8" NPT, Tap wrench, Die stock and Screwdriver.

Item Number



T4032

10

WIRE BRUSH



Wire Brush

Hardened & tempered steel wire bristles, set in 4 rows for professional results.

Item Number



T6238 4

4 Rows

12

MASONRY DRILL BITS

132-134

**BLUE STEEL IMPACT
SCREWDRIVER BITS**

148-151

METAL DRILL BITS

135-137

SCREWDRIVER BITS

152-156

WOOD DRILL BITS

138-141

SCREWDRIVER BIT HOLDERS

156-157

MULTIPURPOSE DRILL BITS

142

JIGSAW BLADES

157-159

HOLESAWS

143-144

SHEET STEEL HOLESAWS

145-146

QUICK CHANGE ARBORS

146-148



POWER TOOL ACCESSORIES



MASONRY DRILL BITS

C.K high performance masonry bits are manufactured from premium quality steels to ensure effective long life performance and conform to relevant international standards.



SDS-Plus Concrete Drill Bits

Tungsten carbide tipped with optimized geometry for drilling concrete and stone. Vacuum brazed tips for durability. Ground flutes designed for optimum debris removal. SDS-Plus shank.

Item Number	Ø	X	Y	
STANDARD	-	-	-	-
T3120 0511	5mm	48mm	110mm	5
T3120 0516	5mm	90mm	160mm	5
T3120 05511	5.5mm	48mm	110mm	5
T3120 05516	5.5mm	90mm	160mm	5
T3120 0611	6mm	48mm	110mm	5
T3120 0616	6mm	90mm	160mm	5
T3120 0621	6mm	140mm	210mm	5
T3120 06516	6.5mm	90mm	160mm	5
T3120 0716	7mm	90mm	160mm	5
T3120 0816	8mm	90mm	160mm	5
T3120 0821	8mm	140mm	210mm	5
T3120 0826	8mm	185mm	260mm	5
T3120 0845	8mm	350mm	450mm	5
T3120 1016	10mm	90mm	160mm	5
T3120 1021	10mm	140mm	210mm	5
T3120 1026	10mm	185mm	260mm	5
T3120 1045	10mm	350mm	450mm	5
T3120 1215	12mm	90mm	160mm	5
T3120 1221	12mm	140mm	200mm	5
T3120 1225	12mm	180mm	260mm	5
T3120 1245	12mm	350mm	450mm	5
T3120 1425	14mm	180mm	260mm	5
T3120 1445	14mm	350mm	450mm	5
T3120 1630	16mm	250mm	310mm	5
T3120 1645	16mm	350mm	450mm	5
T3120 1830	18mm	250mm	310mm	5
T3120 1845	18mm	350mm	450mm	5
T3120 2030	20mm	250mm	310mm	5
T3120 2045	20mm	350mm	450mm	5
T3120 2545	25mm	350mm	450mm	5
EXTRA LONG	-	-	-	-
T3120 12100	12mm	950mm	1000mm	5
T3120 16100	16mm	950mm	1000mm	5
T3120 20100	20mm	950mm	1000mm	5
T3120 25100	25mm	950mm	1000mm	5



SDS Concrete Drill Bit Set of 7

CONTENTS:

1 x drill bit, sizes: 5 x 110, 6 x 110, 8 x 110, 6 x 150, 8 x 150, 10 x 150 and 12 x 150mm.

Item Number		
T3121	Set of 7	5



SDS Chisel Bit Flat - 40mm

SDS+ chisel. Hardened carbon steel for durability.

Item Number			
T3147	40mm	200mm	6



SDS Chisel Bit - Point

SDS+ chisel. Hardened carbon steel for durability.

Item Number		
T3145	250mm	6



SDS Chisel Bit Flat - 20mm

SDS+ chisel. Hardened carbon steel for durability.

Item Number			
T3146	20mm	250mm	6



Concrete Drill Bits SDS-Plus - Full Range Display

CONTENTS:

12 x drill bits, sizes 5.5 x 160mm. 6 x drill bits, sizes: 5.5 x 110 & 7 x 160mm. 3 x drill bits, sizes: 6 x 110, 6 x 160, 6.5 x 160, 8 x 160, 8 x 260 & 10 x 160mm and 2 x drill bits, sizes: 5 x 110, 5 x 160, 6 x 210, 8 x 210, 8 x 450, 10 x 210, 10 x 260, 10 x 450, 12 x 160, 12 x 200, 12 x 260, 12 x 450, 14 x 260 & 16 x 450mm.

Item Number		
T3120RBOM	Stock & stand	1



Concrete Drill Bits SDS-Plus - Top Sellers Display

CONTENTS:

6 x drill bits, sizes: 5.5 x 110, 5.5 x 160 & 7 x 160mm. 3 x drill bits, sizes: 6 x 110, 6 x 160, 8 x 160 & 10 x 160mm and 2 x drill bits, sizes: 10 x 210mm.

Item Number	i	📦
T3120TSBOM	Stock & stand	1



Masonry Drill Bits

Forged steel with tungsten carbide tip for durability. Optimised design for fast and accurate drilling of concrete, stone & brick.

Item Number	∅	Y	📦
T3110 0475	4mm	75mm	10
T3110 05150	5mm	85mm	10
T3110 0585	5mm	150mm	10
T3110 055150	5.5mm	85mm	10
T3110 05585	5.5mm	150mm	10
T3110 06100	6mm	100mm	10
T3110 06150	6mm	150mm	10
T3110 065100	6.5mm	100mm	10
T3110 065150	6.5mm	150mm	10
T3110 07100	7mm	100mm	10
T3110 07150	7mm	150mm	10
T3110 08150	8mm	150mm	10
T3110 10150	10mm	150mm	10
T3110 12150	12mm	150mm	10
T3110 13150	13mm	150mm	10
T3110 14150	14mm	150mm	10
T3110 16150	16mm	150mm	10



Masonry Drill Bit - Set of 5

CONTENTS:

1 x drill bit, sizes: 4, 5.5, 6.5, 7 & 8mm.

Item Number	i	📦
T3111	Set of 5	5



Masonry Hex Drill Bit - Set of 5

CONTENTS:

1 x drill bit, sizes: 4, 5.5, 6.5, 7 & 8mm.

Item Number	i	📦
T3112	Set of 5	4mm



Concrete Drill Bits - Top Sellers Display

CONTENTS:

9 x drill bits, sizes: 7mm, 6 x drill bits, sizes 5 & 5.5mm and 4 x drill bits, sizes: 6, 6.5mm & 8mm.

Item Number	i	📦
T3110TSBOM	Stock & stand	1

METAL DRILL BITS

The new C.K 135° split point HSS drill bits are designed for the fast and effortless penetration of metal. Easy start, split point tips prevent 'drill walk', and ground flutes provide greater accuracy compared to rolled flutes for a cleaner cut.



135° Split Point HSS Drill Bits

DIN 338

Item Number	i	∅	X	Y	
T3100 01	Loose	1mm	12mm	34mm	10
T3100 01TD	Twin Pack	1mm	12mm	34mm	6
T3100 015	Loose	1.5mm	18mm	40mm	10
T3100 015TD	Twin Pack	1.5mm	18mm	40mm	6
T3100 02	Loose	2mm	24mm	49mm	10
T3100 02TD	Twin Pack	2mm	24mm	49mm	6
T3100 025	Loose	2.5mm	30mm	57mm	10
T3100 025TD	Twin Pack	2.5mm	30mm	57mm	6
T3100 03	Loose	3mm	33mm	61mm	10
T3100 03TD	Twin Pack	3mm	33mm	61mm	6
T3100 035	Loose	3.5mm	39mm	70mm	10
T3100 035TD	Twin Pack	3.5mm	39mm	70mm	6
T3100 04	Loose	4mm	43mm	75mm	10
T3100 04TD	Twin Pack	4mm	43mm	75mm	6
T3100 045	Loose	4.5mm	47mm	80mm	10
T3100 045D	Single Pack	4.5mm	47mm	80mm	6
T3100 05	Loose	5mm	52mm	86mm	6
T3100 05D	Single Pack	5mm	52mm	86mm	6
T3100 055	Loose	5.5mm	57mm	93mm	10
T3100 055D	Single Pack	5.5mm	57mm	93mm	6
T3100 06	Loose	6mm	57mm	93mm	10
T3100 06D	Single Pack	6mm	57mm	93mm	6
T3100 065	Loose	6.5mm	63mm	101mm	10
T3100 065D	Single Pack	6.5mm	63mm	101mm	6
T3100 07	Loose	7mm	69mm	109mm	10
T3100 07D	Single Pack	7mm	69mm	109mm	6
T3100 08	Loose	8mm	75mm	117mm	10
T3100 08D	Single Pack	8mm	75mm	117mm	6
T3100 09	Loose	9mm	81mm	125mm	10
T3100 09D	Single Pack	9mm	81mm	125mm	6
T3100 10	Loose	10mm	87mm	133mm	10
T3100 10D	Single Pack	10mm	87mm	133mm	6
T3100 11	Loose	11mm	94mm	142mm	10
T3100 11D	Single Pack	11mm	94mm	142mm	6
T3100 12	Loose	12mm	101mm	151mm	10
T3100 12D	Single Pack	12mm	101mm	151mm	6
T3100 13	Loose	13mm	101mm	151mm	10
T3100 13D	Single Pack	13mm	101mm	151mm	6



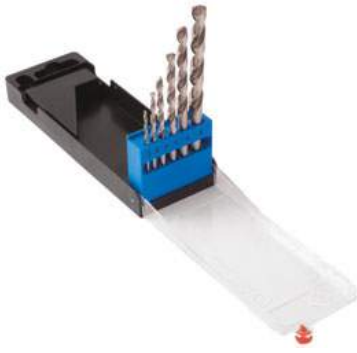

135° Split Point HSS Drill Bits - Set of 6

CONTENTS:
1 x drill bit, sizes: 2, 3, 4, 5, 6 & 8mm.

DIN 338

Item Number		
T3101	Set of 6	3



135° Titanium Nitride Coated HSS Drill - Set of 6

118° tip for the fast cutting of softer materials. Titanium nitride coated for extra wear protection.

CONTENTS:
1 x drill bit, sizes: 2, 3, 4, 5, 6 & 8mm.

Item Number		
T3293	Set of 6	3



135° Split Point HSS Drill Bits - Set of 13

CONTENTS:
1 x drill bit, sizes: 1.5, 2, 2.5, 3, 3.2, 3.5, 4, 4.5, 4.8, 5, 5.5, 6 & 6.5mm.

DIN 338

Item Number		
T3102	Set of 13	3



135° Titanium Nitride Coated HSS Drill - Set of 19

Titanium nitride coated for extra wear protection.

CONTENTS:
1 x drill bit, sizes: 1, 1.5, 2, 2.5, 3, 3.5, 4, 4.5, 5, 5.5, 6, 6.5, 7, 7.5, 8, 8.5, 9, 9.5 & 10mm.

Item Number		
T3291	Set of 19	3



135° Split Point HSS Drill Bits - Set of 19

CONTENTS:
1 x drill bit, sizes: 1, 1.5, 2, 2.5, 3, 3.5, 4, 4.5, 5, 5.5, 6, 6.5, 7, 7.5, 8, 8.5, 9, 9.5 & 10mm.

Item Number		
T3103	Set of 19	1



High Speed Steel Multi-Step Drill - TiN Coated

Centres, drills and deburrs sheet metal in one operation. HSS, precision ground for accurate drilling. Dual flute construction for faster drilling and longer life. Titanium nitride coated for extra wear protection.

Item Number		
T3013	6, 8, 10, 12, 14, 16, 18, 20, 22, 24, 26, 28, 30 & 32mm	1



High Speed Steel Cone Drills

Manufactured from HSS for long lasting performance. Dual flute construction for reduced drilling pressure, faster drilling and longer life. Self starting tip. Three flats on drive shaft for non slip drive in drill chuck.



Metal Drill Bits - Top Sellers Display

CONTENTS:

8 x drill bits, twin pack, sizes: 3 & 3.5mm, 6 x drill bits, twin pack, sizes: 2.5 & 4mm, 8 x drill bits, size: 5mm and 3 x drill bits, size: 6mm.

Item Number		
T3014	6, 8, 10, 12, 14, 16, 18, 20, 22, 24 & 26mm	1
T3015	16, 18, 20, 22, 24, 26, 28, 30 & 32mm	1

Item Number		
T3100SBOM	Stock & stand	1

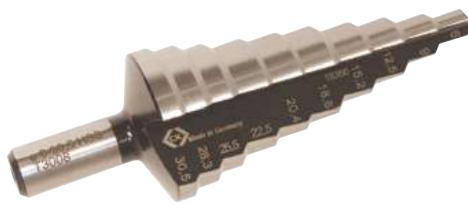

High Speed Steel Multi-Step Drill

Centres, drills and de-burrs thin sheet metal in one operation. Manufactured from HSS for long lasting performance. Dual flute construction for reduced drilling pressure, faster drilling and longer life. Self starting tip. Three flats on drive shaft for non slip drive in drill chuck.



Metal Drill Bits - Full Range Display

CONTENTS:

8 x drill bits, twin packs, sizes: 3 & 3.5mm, 6 x drill bits, twin packs, sizes: 1, 1.5, 2, 2.5 & 4mm, 8 x drill bits, size: 5mm, 6 x drill bits, sizes: 4.5 & 5.5mm and 3 x drill bits, sizes: 6, 6.5, 7, 8, 9, 10, 12 & 13mm.

Item Number		
T3011	6, 8, 10, 12, 14, 16, 18, 20, 22, 24, 26, 28, 30 & 32mm	1
T3012	12.5, 12.7, 15.2, 16.2, 18.6, 20.4, 22.5, 25.4, 28.3, 30.5 & 32.5mm	1
T3008	6, 9, 12.3, 15.2, 18.6, 20.4, 22.5, 25.4, 28.3 & 30.5mm	1
T3010 1	4, 6, 8, 10, 12, 14, 16, 18 & 20mm	1

Item Number		
T3100RBOM	Stock & stand	1

WOOD DRILL BITS

A range of twist and flat drill bits with precision ground cutting edges for fast and smooth drilling of hard and soft wood.



Fast4 Wood Drill Bits

4 blades offering 100% more cutting blade than a flat bit for faster drilling. Optimised flute geometry for faster waste removal. Precision ground cutting edges with outer spur blades for a smoother cut & cleaner breakout. Screw point allows accurate positioning and pulls the bit through with less effort.

Item Number	Ø	X	Y	i	📦
T2943-16	16mm	110mm	160mm	standard	10
T2943-20	20mm	110mm	160mm	standard	10
T2943-22	22mm	110mm	160mm	standard	10
T2943-25	25mm	110mm	160mm	standard	10
T2943-32	32mm	110mm	160mm	standard	10



Fast4 Wood Drill Bits - Set of 4

CONTENTS: 16, 20, 25 & 32mm

Item Number	i	📦
T2943S4	Set of 4	3



Fast4 Wood Drill Bits SDS-Plus

4 blades offering 100% more cutting blade than a flat bit for faster drilling. Optimised flute geometry for faster waste removal. Precision ground cutting edges with outer spur blades for a smoother cut & cleaner breakout. Screw point allows accurate positioning and pulls the bit through with less effort.

Item Number	Ø	X	Y	i	📦
T2944-16	16mm	110mm	160mm	SDS-Plus	10
T2944-20	20mm	110mm	160mm	SDS-Plus	10
T2944-22	22mm	110mm	160mm	SDS-Plus	10
T2944-25	25mm	110mm	160mm	SDS-Plus	10
T2944-32	32mm	110mm	160mm	SDS-Plus	10



Fast4 drill bits - Full range display

CONTENTS:

5 x drill bits, size: 25mm, 3 x drill bits, size: 20mm and 2 x drill bits, sizes: 16, 22 & 32mm.

Item Number	i	📦
T2943RBOM	Standard, stock & stand	1
T2944RBOM	SDS-Plus, stock & stand	1



Wood Drill Bits

Chrome vanadium steel for long life performance. Brad point for accurate drill starts. Spur ground external edge for clean hole cutting.

Item Number	Ø	X	Y	📦
T3035 03	3mm	33mm	61mm	10
T3035 04	4mm	43mm	75mm	10
T3035 05	5mm	52mm	86mm	5
T3035 06	6mm	60mm	97mm	5
T3035 08	8mm	75mm	117mm	5
T3035 10	10mm	87mm	133mm	5
T3035 12	12mm	96mm	151mm	5
T3035 13	13mm	96mm	151mm	5
T3035 14	14mm	97mm	151mm	5
T3035 16	16mm	100mm	160mm	5

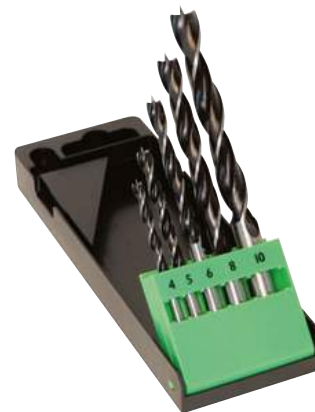

Wood Drill Bit - Set of 5

CONTENTS:

5 x drill bit, sizes: 4, 5, 6, 8 & 10mm.

Item Number	i	📦
T3040	Set of 5	3



Wood Drill Bits - Top sellers display

CONTENTS:

6 x drill bits, sizes: 3, 4 & 5mm.

3 x drill bits, sizes: 6, 8 & 10mm.

Item Number		
T3035TSBOM	Stock & stand	1



Auger Bits - Top sellers display

CONTENTS:

2 x auger bits, sizes: 10, 20 & 25mm and 1 x auger bit, sizes: 13, 16 & 22mm.

Item Number		
T3031TSBOM	Stock & stand	1



Auger Wood Drill Bits

Professional quality high carbon steel, hardened and precision ground for fast hole cutting. Spur lip for clean hole results. Screw tip for precise hole starts. Combination shank suitable for hand and power drills.



Flat Wood Bit - Extension Drive

Extension drive shaft for flat bits with E6.3 drive.

Item Number	\emptyset	X	Y	
STANDARD	-	-	-	-
T3031 06	6mm	90mm	160mm	6
T3031 08	8mm	100mm	170mm	6
T3031 10	10mm	120mm	190mm	6
T3031 13	13mm	120mm	190mm	6
T3031 16	16mm	130mm	200mm	6
T3031 20	20mm	140mm	210mm	6
T3031 22	22mm	140mm	210mm	6
T3031 25	25mm	140mm	210mm	6
T3031 30	30mm	140mm	210mm	6
T3031 32	32mm	140mm	210mm	6
LONG	-	-	-	-
T3034 10	10mm	220mm	300mm	6
T3034 13	13mm	220mm	300mm	6
T3034 16	16mm	220mm	300mm	6
T3034 20	20mm	220mm	300mm	6
T3034 22	22mm	220mm	300mm	6
T3034 25	25mm	220mm	300mm	6

Item Number		
T2940-2	300mm	3



Countersink Bit

Manufactured from high speed steel. hardened and tempered for long life. Suitable for use with hand or power drills on hard or softwood and plastics.

Item Number		
T2601S 3760	3/8 x 60°	6
T2601S 5090	1/2 x 90°	6



Flat Wood Drill Bits

HSS, hardened for long life performance. Brad pointed for accurate drill starts. Ground wing spur for cleanhole cutting.

Item Number	Ø	X	Y	
STANDARD	-	-	-	-
T2942-06	6mm	130mm	160mm	5
T2942-08	8mm	130mm	160mm	5
T2942-10	10mm	130mm	160mm	5
T2942-12	12mm	130mm	160mm	5
T2942-13	13mm	130mm	160mm	5
T2942-14	14mm	130mm	160mm	5
T2942-16	16mm	130mm	160mm	5
T2942-20	20mm	130mm	160mm	5
T2942-22	22mm	130mm	160mm	5
T2942-25	25mm	130mm	160mm	5
T2942-28	28mm	130mm	160mm	5
T2942-32	32mm	130mm	160mm	5
T2942-38	38mm	130mm	160mm	5
LONG	-	-	-	-
T2942-12400	12mm	370mm	400mm	5
T2942-16400	16mm	370mm	400mm	5
T2942-20400	20mm	370mm	400mm	5
T2942-25400	25mm	370mm	400mm	5
T2942-32400	32mm	370mm	400mm	5



Flat Wood Bit - Set of 6

CONTENTS:

6 x wood bits, sizes: 10, 13, 16, 20, 22 & 25mm.

Item Number		
T2942P	Set of 6	5



Flat Bits - Top sellers display

CONTENTS:

2 x flat bits, sizes: 20 & 25mm, 3 x flat bits, sizes: 13, 16 & 22mm and 1 x flat bit, size: 32mm.

Item Number		
T2942TSBOM	Stock & stand	1



Flat Bits Long - Stocked display stand

CONTENTS:

3 x flat bits, sizes: 12mm x 400mm, 16mm x 400mm, 20 x 400mm, 4 x flat bits, sizes: 25mm x 400mm, and 2 x flat bit, size: 32mm x 400mm.

Item Number		
T2942LS	Stock & stand	

MULTIPURPOSE DRILL BITS

Tungsten carbide tipped drills specially designed for drilling through concrete, brick, cement, stone, metal & ceramics.



Universal Drill Bit - Set of 5

CONTENTS:

5 x universal drill bit, sizes: 4, 5, 6, 8 & 10mm

Item Number	i	📦
T3063	Set of 5	3



Masonry, Metal & Wood Drill Bit - Set of 16

CONTENTS:

1 x brick drill bit, sizes: 4, 5.5, 6.5, 7 & 8mm, 1 x metal drill bit, sizes: 2, 3, 4, 5, 6 & 8mm and 1 x wood drill bit, sizes: 4, 5, 6, 8 & 10mm.

Item Number	i	📦
T3064B	Set of 16	10



Drill Saw - Tin - Twin Pack

Titanium nitride coated HSS for strength and durability. Drills and cuts to create any size or shape hole. Cuts through wood/plastic up to 5mm, aluminium up to 4mm and metal up to 3mm thick.

Item Number	∅	📦
T3193T	6mm	5

HOLESAWS

Superior cutting performance:

High speed varipitch tooth configuration.

Extended working life:

Premium grade 8% cobalt alloy steel construction.

Suitable for cutting:

Aluminium, steel, cast iron, wood and brass.



Superior Performance



Extreme Durability

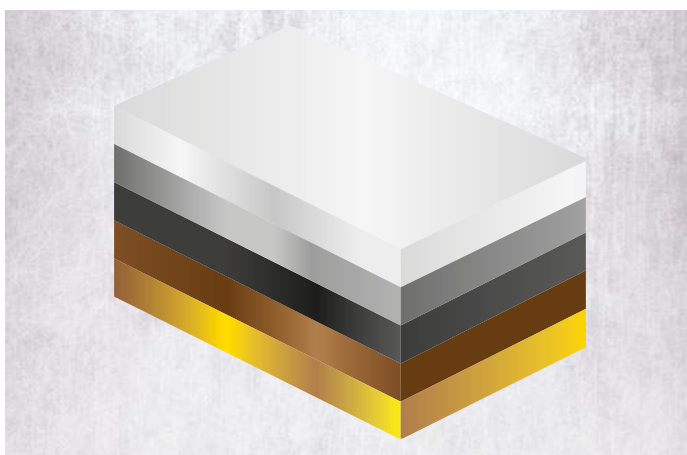

Multi Purpose

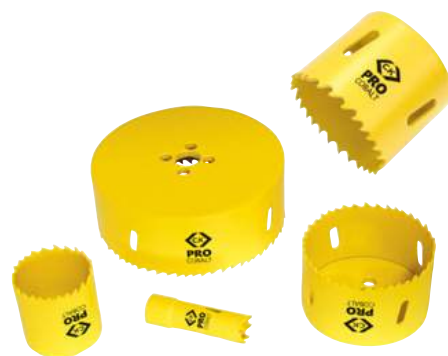

ProCobalt Holesaws

Professional quality holesaw constructed from premium grade 8% cobalt alloy steel with hardened vari-pitch teeth for fast clean cutting of holes in steel, stainless steel, die cast metals, nail embedded wood, hardwood floors, plywood, plastics etc.

Item Number	Ø	
424001	16mm 5/8"	10
424002	19mm 3/4"	10
424003	20mm 25/32"	10
424005	22mm 7/8"	10
424006	25mm 1"	10
424007	29mm 1.1/8"	10
424008	32mm 1.1/4"	10
424010	38mm 1.1/2"	10
424011	40mm 1.9/16"	10
424012	41mm 1.5/8"	10
424013	43mm 1.11/16"	10
424014	44mm 1.3/4"	10
424015	48mm 1.7/8"	10
424016	51mm 2"	10
424017	54mm 2.1/8"	10
424018	57mm 2.1/4"	10
424019	60mm 2.3/8"	10
424020	64mm 2.1/2"	10
424021	65mm 2.9/16"	10
424022	67mm 2.5/8"	10
424023	68mm 2.11/16"	10
424024	70mm 2.3/4"	10
424025	73mm 2.7/8"	10
424026	76mm 3"	10
424027	79mm 3.1/8"	10
424028	83mm 3.1/4"	10
424029	86mm 3.3/8"	10
424030	89mm 3.1/2"	10
424031	92mm 3.5/8"	10
424032	95mm 3.3/4"	10
424033	102mm 4"	10
424034	105mm 4.1/8"	10
424035	111mm 4.3/8"	10
424036	114mm 4.1/2"	10
424050	127mm 5"	10
424060	152mm 6"	10



Holesaw Kit - 6 Piece

CONTENTS:
1 x holesaw, sizes 40, 5, 65, 67 & 68mm and quick release arbor 32-114mm (11mm shaft).

Item Number	i	
424044	6 Piece	10



Downlight Holesaw Kit - 6 Piece Set

CONTENTS:
1 x holesaw, sizes: 65, 70, 76 & 83mm, quick release arbor 32-114mm (11mm shaft) and hexagon key 4mm.

Item Number	i	
424046	6 Piece Set	10



Holesaw Kit - 9 Piece

CONTENTS:
1 x holesaw, sizes: 22, 29, 35, 44, 51 & 64mm, arbor 14-30mm (8mm shaft), locking arbor 32-114mm (11mm shaft) and hexagon key 4mm.

Item Number	i	
424043	9 Piece	10



Electricians Holesaw Kit - 9 Piece

CONTENTS:
1 x holesaw, sizes: 16, 20, 25, 32, 38 & 51mm, arbor 14-30mm (8mm shaft), quick release arbor 32-114mm (11mm shaft) and hexagon key 4mm.

Item Number	i	
424045	9 Piece	10



SHEET STEEL HOLESAWS

Faster:

Cuts sheet steel faster than standard holesaws.

Smoother:

Smoother cutting action reduces burring.

Tougher:

8% cobalt alloy steel construction and slimline design prevents tooth burnout.



Sheet Steel Holesaws

Specifically designed for the cutting of sheet metals. Cuts sheet steel faster than standard holesaws. Smoother cutting action reduces burring. 8% cobalt alloy steel construction and slimline design prevents tooth burnout.

Item Number	Ø	📦
T3202 016	16mm	6
T3202 020	20mm	6
T3202 022	22mm	6
T3202 025	25mm	6
T3202 032	32mm	6
T3202 038	38mm	6



Sheet Steel Holesaw - 3 Piece Set

CONTENTS:

20, 25 & 32mm.

Item Number	i	📦
T3213	3 Piece Set	6



Holesaws & Accessories - Range Display

CONTENTS:

1 x holesaw, sizes: 16, 19, 20, 22, 25, 29, 32, 38, 40, 44, 48, 51, 54, 57, 60, 64, 65, 67, 70, 73, 76, 79, 83, 89, 92, 95, 102, 105, 111 & 114mm, 1 x arbor 14-30mm (8mm shaft), 1 x arbor 14-30mm (11mm shaft), 1 x quick release arbor 32-114mm (11mm shaft), 1 x locking arbor 32-114mm (11mm shaft), 1 x SDS arbour 14-30mm, 1 x SDS quick release arbour 32-114mm, 1 x replacement pilot drill (for 424037, 424047 & 424048), 1 x replacement pilot drill (for 424038, 424039 & 424040) and 1 x extension drive.

Item Number	i	📦
400002	Stock & stand	1



Sheet Steel Holesaw Display

CONTENTS:

2 x 16mm, 2 x 20mm, 2 x 22mm, 2 x 25mm, 2 x 32mm and 2 x 28mm.

Item Number		
T3202R	Stock & backing card	1



Pilot Drill Assembly

Replacement Pilot Drill for T3202 Holesaws

Item Number	
T3212	6



Hole Enlarging Adapter

Allows the nesting of one holesaw inside another for concentric enlarging of existing holes. Double threaded to accept any size of holesaw.

Item Number	
T3216	6

QUICK CHANGE ARBORS

Rapid Release system:

Enables fast and tool free holesaw changeover.

Universal Fitting:



Compatible with most brands of holesaws.

Suitable for holesaws from:

16 - 152mm.



Quick Change Arbor

Item Number		
T3214	Set contents: Arbor, large & small adapter	6
T3215 1	Adapters for holesaws up to 30mm	6
T3215 2	Adapters for holesaws over 30mm	6



Locking Arbor - For 32-114mm Holesaws

Heavy duty hole saw arbor for use with C.K holesaws from 32mm - 114mm. Fixing pins are locked in place with a screw down collar securing the holesaw for heavy duty use. 11mm hexagonal drive shaft. Supplied with replaceable 1/4" HSS pilot drill.

Item Number		
424040	11mm	10



Quick Release SDS-Plus Arbor - For 32-114mm Holesaws

Quick-release hole saw arbor for use with C.K holesaws from 32mm - 114mm. Fixing pins are spring loaded for easy withdrawal making holesaw changes fast and efficient. SDS Plus drive shaft. Supplied with replaceable 1/4" HSS pilot drill.

Item Number		
424048	SDS-Plus	10



Quick Release Arbor - For 32-114mm Holesaws

Quick-release hole saw arbor for use with C.K holesaws from 32mm - 114mm. Fixing pins are spring loaded for easy withdrawal making holesaw changes fast and efficient. 11mm hexagonal drive shaft. Supplied with replaceable 1/4" HSS pilot drill.

Item Number		
424039	11mm	10



SDS-Plus Arbor - For 14-30mm Holesaws

Hole saw arbor for use with C.K holesaws up to 30mm. SDS Plus drive shaft. Supplied with replaceable 1/4" HSS pilot drill.

Item Number		
424047	SDS-Plus	10



Arbor for 14-30mm Holesaws

Hole saw arbor for use with C.K holesaws up to 30mm. Hexagonal drive shaft. Supplied with replaceable 1/4" HSS pilot drill.

Item Number		
424037	8mm	10
424038	11mm	10



Replacement Pilot Drill



Replacement HSS pilot drill bit for C.K holesaw arbor 424037.

Item Number		
424041	For Arbors 424037, 424047 & 424048	10
424042	For Arbors 424038, 424039, 424040 & T3214	10



Extension Drive 300mm - For 11m Arbor

300mm Extension bar for all C.K 11mm hexagonal shaft arbors. Complete with shaft locking grub screw.

Item Number			
424049	11mm	300mm	10



Quick Change Arbor Display

CONTENTS:

3 x Quick Change Arbor Kits, 3 x Holesaw Adapter for Holesaws up to 30mm and 3 x Holesaw Adapter for Holesaws over 30mm.

Item Number		
T3214R	Stock & backing card	1

BLUE STEEL IMPACT SCREWDRIVER BITS

Manufactured from specially formulated V8 steel alloy for extreme toughness, and featuring torsion control technology to withstand the stresses of high torque applications, C.K Blue Steel Impact Bits provide a vastly extended working life.



Torsion Control Technology

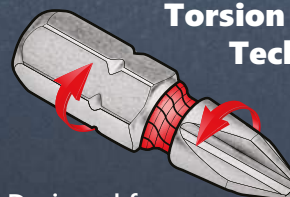

Designed for high torque applications



Blue Steel Impact Screwdriver Bits - PZ

25mm bit.

Item Number			
Loose	-	-	-
T4560 PZ1	PZ1	25mm	10
T4560 PZ2	PZ2	25mm	10
T4560 PZ3	PZ3	25mm	10
Carded Triple Pack	-	-	-
T4560 PZ1D	PZ1	25mm	6
T4560 PZ2D	PZ2	25mm	6
T4560 PZ3D	PZ3	25mm	6



Blue Steel Impact Screwdriver Bits - PZ

Trade Pack.

Item Number				
T4560 PZ2D15	x 15	PZ2	25mm	6
T4560 PZ2LD10	x 10	PZ2	50mm	6



Blue Steel Impact Screwdriver Bits - PZ

50mm bit.

Item Number			
Loose	-	-	-
T4560 PZ1L	PZ1	50mm	10
T4560 PZ2L	PZ2	50mm	10
Carded Triple Pack	-	-	-
T4560 PZ1LD	PZ1	50mm	6
T4560 PZ2LD	PZ2	50mm	6
T4560 PZ3LD	PZ3	50mm	6



Blue Steel Impact Screwdriver Bits - PH

25mm bit.

Item Number			
Loose	-	-	-
T4560 PH1	PH1	25mm	10
T4560 PH2	PH2	25mm	10
T4560 PH3	PH3	25mm	10
Carded Triple Pack	-	-	-
T4560 PH2D	PH2	50mm	6



Blue Steel Impact Screwdriver Bits - PH



50mm bit.

Item Number			
Loose	-	-	-
T4560 PH2L	PH2	50mm	10
Carded Triple Pack	-	-	-
T4560 PH2LD	PH2	50mm	6



Blue Steel Impact Screwdriver Bits



25mm bit - Loose.

Item Number			
T4560 SL45	4.5mm	25mm	10
T4560 SL55	5.5mm	25mm	10
T4560 SL65	6.5mm	25mm	10



Blue Steel Impact Screwdriver Bits



25mm bit - Loose.

Item Number			
T4560 HEX25	2.5mm	25mm	10
T4560 HEX30	3.0mm	25mm	10
T4560 HEX40	4.0mm	25mm	10
T4560 HEX50	5.0mm	25mm	10
T4560 HEX60	6.0mm	25mm	10



Blue Steel Impact Screwdriver Bits



25mm bit (Standard) - Loose.

Item Number			
T4560 TX05	TX05	25mm	10
T4560 TX06	TX06	25mm	10
T4560 TX07	TX07	25mm	10
T4560 TX08	TX08	25mm	10
T4560 TX09	TX09	25mm	10
T4560 TX10	TX10	25mm	10
T4560 TX15	TX15	25mm	10
T4560 TX20	TX20	25mm	10
T4560 TX25	TX25	25mm	10
T4560 TX27	TX27	25mm	10
T4560 TX30	TX30	25mm	10
T4560 TX40	TX40	25mm	10



Blue Steel Impact Screwdriver Bits



25mm bit - Loose.

Item Number			
T4560 ROB1	ROB1	25mm	10
T4560 ROB2	ROB2	25mm	10
T4560 ROB3	ROB3	25mm	10



Blue Steel Impact Screwdriver Bits

25mm bit (Tamperproof) - Loose.

Item Number			
T4560 TXTP10	TX10	25mm	10
T4560 TXTP15	TX15	25mm	10
T4560 TXTP20	TX20	25mm	10
T4560 TXTP25	TX25	25mm	10
T4560 TXTP30	TX30	25mm	10



Blue Steel Impact Bit -Set of 10- PZ/PH

CONTENTS:
PZ1 x2, PZ2 x5, PZ3 x1,
PH2 x1 and Screwdriver Bit Holder x1.

Item Number			
T4510	Set of 10	25mm	20



Blue Steel Impact Bit - Set of 6 - PZ

CONTENTS:
PZ1 x2, PZ2 x3 and PZ3 x1.

Item Number	i	←→	📦
T4511	Set of 6	50mm	20



Blue Steel Impact Bit - Set of 6 - PH

CONTENTS:
PH1 x2, PH2 x3 and PH3 x1.

Item Number	i	←→	📦
T4512	Set of 6	50mm	20



Blue Steel Impact Bit - Set of 6 - TX

CONTENTS:
TX15 x1, TX20 x2, TX25 x2 and TX30 x1

Item Number	i	←→	📦
T4513	Set of 6	50mm	20



Blue Steel Impact Screwdriver Bits - Top Sellers Display

CONTENTS:
5 x screwdriver bits, carded triple packs, PZ size: 2 x 25mm
3 x screwdriver bits, carded triple packs, PZ size: 1 x 25, 2 x 50 & 3 x 25mm and 1 x screwdriver bits, box of 15, PZ, size 2.

Item Number	i	📦
T4560TSBOM	Stock & stand	1

SCREWDRIVER BITS



S2 Steel Screwdriver Bits

50mm bit.

Item Number			
Loose	-	-	20
T4545 1	MOD1	50mm	20
T4545 2	MOD2	50mm	20
Carded Twin Pack	-	-	10
422001	MOD1 & 2	50mm	10



S2 Steel Screwdriver Bits

25mm bit - Loose Titanium Nitride coated for extra wear protection.

Item Number			
T4557TIN 10	TX10	25mm	10
T4557TIN 15	TX15	25mm	10
T4557TIN 20	TX20	25mm	10
T4557TIN 25	TX25	25mm	10
T4557TIN 30	TX30	25mm	10
T4557TIN 40	TX40	25mm	10



Screwdriver Bit - Set of 7 - PZ

CONTENTS:

PZ1 x1, PZ2 x4, PZ3 x1 and Screwdriver Bit Holder x1..

Item Number			
T4517	Set of 7	25mm	12



Screwdriver Bit - Set of 7 - PH

CONTENTS:

PH1 x1, PH2 x4, PH3 x1 and Screwdriver Bit Holder x1.

Item Number			
T4518	Set of 7	25mm	12



Screwdriver Bit - Set of 7 - TX

CONTENTS:

TX10 x1, TX15 x1, TX20 x1, TX25 x1, TX30 x1, TX40 x1 and Screwdriver Bit Holder x1.

Item Number			
T4501	Set of 7	25mm	12



Screwdriver Bit - Set of 31 - Mixed

CONTENTS:

PZ1 x1, PZ2 x4, PZ3 x1, TX10 x2, TX15 x4, TX20 x4, TX25 x2, TX30 x2, TX40 x1, PH1 x1, PH2 x2, SL4.0 x1, SL5.5 x1, SL6.5 x1, HEX4 x1, HEX5 x1, HEX6 x1 and Screwdriver Bit Holder x1.

Item Number			
T4502	Set of 31	25mm	6



Screwdriver Bit - Set of 7 - Mixed

CONTENTS:
SL5.5 x1, SL6.5 x1, PZ1 x1, PZ2 x1, PH1 x1, PH2 x1 and Screwdriver Bit Holder x1.

Item Number			
T4583C	Set of 7	25mm	20



Screwdriver Bit - Set of 41 - Mixed

CONTENTS:
PH1 x2, PH2 x4, PH3 x2, PZ1 x4, PZ2 x8, PZ3 x4, 4mm x2, 5.5mm x2, 6mm x2, 8mm x2, TX15 x1, TX20 x1, TX25 x1, TX30 x1, 3mm x1, 4mm x1, 5mm x1, 6mm x1 and Screwdriver Bit Holder x1.

Item Number			
T4509	Set of 41	25mm	6



Screwdriver Bit - Set of 7 - PZ

Titanium Nitride coated for extra wear protection.

CONTENTS:
PZ1 x1, PZ2 x4, PZ3 x1 and Screwdriver Bit Holder x1.

Item Number			
T4569TINC	Set of 7	25mm	20



- Spanner
- Torq Set
- Tri-Wing
- Clutch

Screwdriver Security Bit - Set of 41 - Mixed

CONTENTS:
PH0 x1, PH1 x1, PH2 x3, PH3 x1. PZ0 x1, PZ1 x1, PZ2 x1, PZ3 x1. Slotted sizes 4mm x1, 5mm x1, 6mm x1, 8mm x1. Spline sizes 4 x1, size 5 x1, size 6 x1, size 8 x1. Spanner sizes 4 x1, size 6 x1, size 8 x1, size 10 x1. Torq set sizes 6 x1, size 8 x1, size 10 x1. TX8 x1, TX10 x1, TX15 x1, TX20 x1. TX25 x1, TX27 x1, TX30 x1, TX40 x1. Tri-wing sizes 1 x1, size 2 x1, size 3 x1, size 4 x1. Clutch sizes 1 x1, size 2 x1, size 3x1. Screwdriver bit holder.

Item Number			
T4508	Set of 41	25mm	6



Screwdriver Bit - Set of 8 - PZ/PH

CONTENTS:

PZ0 x1, PZ1 x1, PZ2 x1, PZ3 x1 and PZ0 x1, PZ1 x1, PZ2 x1, PZ3 x1.

Item Number	i	↔	📦
T4522	Set of 8	25mm	6



Screwdriver Bit - Set of 8 - TX Tamperproof

CONTENTS:

TX08 x1, TX10 x1, TX15 x1, TX20 x1, TX25 x1, TX27 x1, TX30 x1 & TX40 x1.

Item Number	i	↔	📦
T4527	Set of 8	25mm	6

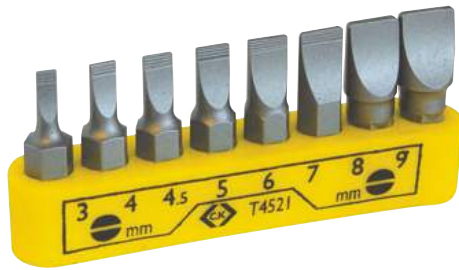

Screwdriver Bit - Set of 8 - Slotted

CONTENTS:

3.0mm x1, 4.0 x1, 4.5mm x1, 5.0mm x1, 5.5mm x1, 6.0mm x1, 7.0mm x1, 8.0mm x1 & 9.0mm x1.

Item Number	i	↔	📦
T4521	Set of 8	25mm	6



Screwdriver Bit - Set of 8 - Hexagon

CONTENTS:

1.5mm x1, 2.0mm x1, 2.5mm x1, 3.0mm x1, 4.0mm x1, 5.0mm x1, 5.5mm x1 & 6.0mm x1.

Item Number	i	↔	📦
T4524	Set of 8	25mm	6



Screwdriver Bit - Set of 8 - TX

CONTENTS:

TX08 x1, TX10 x1, TX15 x1, TX20 x1, TX25 x1, TX27 x1, TX30 x1 & TX40 x1.

Item Number	i	↔	📦
T4523	Set of 8	25mm	6



Screwdriver Bit - Set of 8 - Hexagon Tamperproof

CONTENTS:

2.0mm x1, 2.5mm x1, 3.0mm x1, 4.0mm x1, 5.0mm x1, 5.5mm x1, 6.0mm x1, 7.0mm x1.

Item Number	i	↔	📦
T4528	Set of 8	25mm	6



Screwdriver Bit - Set of 33 - Mixed

CONTENTS:

Slotted sizes 3mm x1, 4mm x1, 4.5mm x1, 5mm x1, 5.5mm x1, 6mm x1, 7mm x1, 8mm x1, 9mm x1, TX08 x1, TX10 x1, TX15 x1, TX20 x1, TX25 x1, TX27 x1, TX30 x1, TX40 x1, Hex sizes 1.5mm x1, 2mm x1, 2.5mm x1, 3mm x1, 4mm x1, 5mm x1, 5.5mm x1, 6mm x1, PH0 x1, PH1 x1, PH2 x1, PH3 x1, PZ0 x1, PZ1 x1, PZ2 x1, PZ3 x1 and Screwdriver Bit Holder x1.

Item Number	i	↔	📦
T4520	Set of 33	25mm	6



Screwdriver Bit - Set of 10 - Long

CONTENTS:

4.5mm x1, 7mm x1, PH1 x1, PH2 x1, PH3 x1, PZ1 x1, PZ2 x1, PZ3 x1 and TX15 x1, TX20 x1.

Item Number	i	↔	📦
T4525	Set of 10	100mm	6



Screwdriver Bit - Set of 27 - Mixed

CONTENTS: Slotted sizes 4mm x1, 5mm x1, 6mm x1, 7mm x1, PZ1 x1, PZ2 x1, PZ3 x1, PH1 x1, PH2 x1, PH3 x1, Hex sizes 3mm x1, 4mm x1, 5mm x1, 6mm x1, TX10 x1, TX15 x1, TX20 x1, TX25 x1, TX30 x1, TX40 x1, Screwdriver Bit Holder x1, Drill/driver sizes: 2.5mm PZ1 x2, 3mm PZ2 x2, 4mm PZ3 x1 and Quick change chuck x1.

Item Number	↔	📦
T4519	25mm	6



Magnetic Nut Drivers - Set of 7

CONTENTS:

7mm x1, 8mm x1, 10mm x1, 11mm x1, 13mm x1, 1/4" x1, 3/8" x1.

Item Number	i	📦
T4514	Set of 7	14



Magnetic Nut Driver

For fast and convenient driving of 8mm hex head screw fixings. Forged alloy steel for strength and durability.

Item Number	i	🔗	📦
T4598	Loose	8mm	10
T4598C	Carded	8mm	10



Damaged Screw Remover

Designed for the fast removal of damaged non hardened screws. Hardened high speed steel with hexagon shaft for use with reversible drill. Pack contains two sizes for screws 6 – 10 & 12 – 14.

Item Number		
422003	Set of 2	12



Screwdriver Bit Holder - Locking

Locking mechanism securely retains the bit in place. Quick release mechanism allows fast & convenient bit changes. E6.3 drive.

Item Number		
T4564D	60mm	6

SCREWDRIVER BITS HOLDERS



Screwdriver Bit Holder

Strong & corrosion resistant stainless steel sleeve. Magnetic base and the c-ring securely retains the bit in place. E6.3 drive.

Item Number		
T4570	60mm	10
T4570 100	100mm	6
T4570 200	200mm	6



Screwdriver Bit Holder - Screw Grip

Magnetic base retains the bit in place. Magnetic collar holds the screw in place. E6.3 drive.

Item Number		
T4567D	70mm	6



Screwdriver Bit Holder - SDS Plus

Strong & corrosion resistant stainless steel sleeve. Magnetic base retains the bit in place. SDS Plus drive shaft.

Item Number		
T4564SDSC	74mm	20



Screwdriver Bit Holder - Pivot Joint

Magnetic base securely retains the bit in place. Pivoting head for when straight line access isn't possible. Lockable collar for use as a straight bit holder. E6.3 drive.

Item Number		
T4504	100mm	25



Keyless Chuck 1/4" - Hex Drive

1/4" hex to 3 jaw chuck converter. E6.3 drive.

Item Number		
T2463	6mm / 1/4"	6



Triton XLS Screwdriver Bit

Large softgrip Tri-Lobe handle for high torque applications. Strong & corrosion resistant stainless steel sleeve. Magnetic base and c-ring securely retains the bit in place.

Item Number		
T4516	6mm / 1/4"	12



Screwdriver Bit Holder Hand Driver

High quality chrome vanadium steel shaft hardened, tempered and chrome plated. High strength stainless steel magnetic bit holder for 1/4" bits. Shatterproof acetate wipe clean handle.

Item Number	
T4581	6

JIGSAW BLADES



Jigsaw Blades (5 pack) - 50mm

Thin, Metal Straight Cuts.

Item Number			BOSCH		
T0865A	2.5mm	1.5-3mm	T118A	Pack of 5	5



Jigsaw Blades (5 pack) - 75mm

Wood, Fast Coarse Cuts.

Item Number			BOSCH		
T0865B	2.5mm	5-60mm	T111C	Pack of 5	5



Jigsaw Blades (5 pack) - 75mm

Wood, Precise Cuts.

Item Number			BOSCH		
T0865C	2.5mm	4-30mm	T101B	Pack of 5	5



Jigsaw Blades (5 pack) - 50mm

Thicker Metal, Straight Cuts.

Item Number			BOSCH		
T0865H	1.2mm	3-60mm	T118B	Pack of 5	5



Jigsaw Blades (5 pack) - 75mm

Wood Laminates, Down Cuts.

Item Number			BOSCH		
T0865R	2.5mm	4-30mm	T101BR	Pack of 5	5



Jigsaw Blades (5 pack) - 75mm

Wood, Fast Clean Cuts.

Item Number			BOSCH		
T0865L	4mm	6-60mm	T101D	Pack of 5	5



Jigsaw Blades (5 pack) - 75mm

Wood, Extra Clean Curved Cuts.

Item Number			BOSCH		
T0865T	2.5mm	4-30mm	T244D	Pack of 5	5



Jigsaw Blades (5 pack) - 95mm

Wood, Fast Extra Clean Cuts.

Item Number			BOSCH		
T0865P	4mm	8-75mm	-	Pack of 5	5



Jigsaw Blades (5 pack) - 110mm

Universal.

Item Number			BOSCH		
T0865W	1.8-2.5mm	3-100mm	-	Pack of 5	5



Jigsaw Blades (5 pack) - 75mm

Wood, Fast Double Cuts.

Item Number			BOSCH		
T0865X	2.0mm	3-60mm	-	Pack of 5	5



Jigsaw Blades - Range display

CONTENTS:

3 x jigsaw blade packs, types: A, B, C, L, R, T, W, X & Y.

Item Number		
T0865RBOM	Stock & stand	1

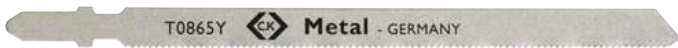

Jigsaw Blades (5 pack) - 110mm

Metal & Sandwich Materials.

Item Number			BOSCH		
T0865Y	1.2mm	1.5-3mm	T318A	Pack of 5	5

HOSE CONNECTORS

162-164

HOSE ACCESSORIES

164-165

HOSE PIPES

165-167

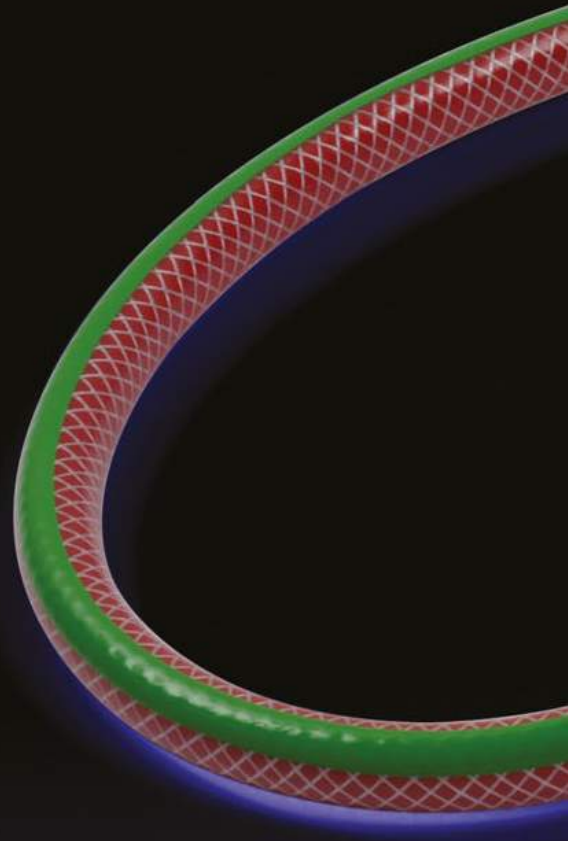

WATERING SYSTEMS





WATER SYSTEMS

The range of C.K hose connectors is precision engineered to be long lasting and leak free. The fittings are solid brass, so are much more hard wearing than plastic systems and are rust resistant. They are compatible with all popular makes of hoses of both 1/2" and 3/4" bores.

- 1 Solid brass - tough and corrosion resistant
- 2 Ball bearing locking - secure and hardwearing
- 3 Threaded clamp for a secure fit to hosepipe

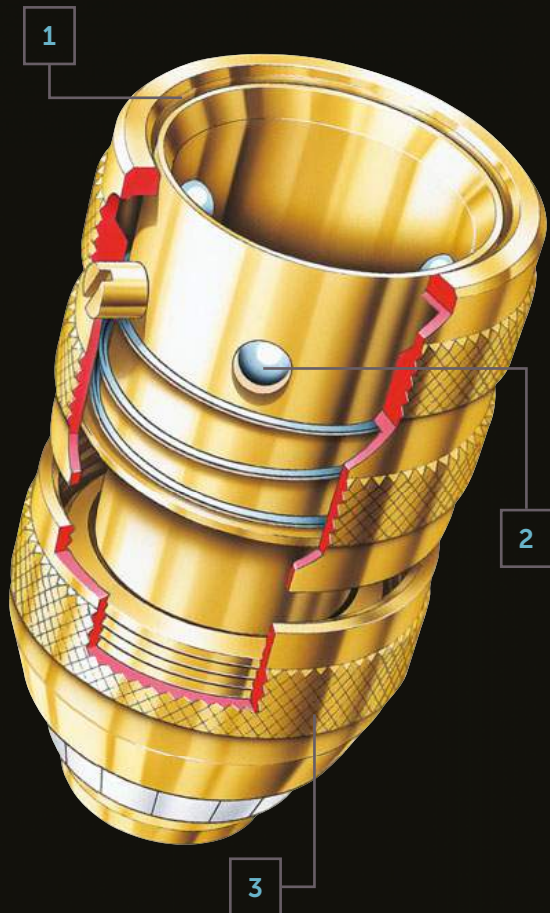

HOSE CONNECTORS



Hose Connector - Male

Item Number	Ø	
G7904	1/2"	6
G7934	3/4"	6



Hose Connector - Female

Item Number	Ø	
G7903	1/2"	6
G7933	3/4"	6



Hose Connector - Male & Female

Item Number	Ø	
G7905	1/2"	6



Hose connector - Double Male

Item Number	Ø	Icon
G7907	1/2"	6



Hose Connector - Triple Male

Item Number	Ø	Icon
G7907Y	1/2"	6



Hose Connector - Water Stop

Automatic water cut off feature allows the interchange of accessories such as sprinklers, nozzles, spray guns, etc.

Item Number	Ø	Icon
G7913	1/2"	6



Tap Connector - Threaded Female

Tap connector for threaded taps.

Item Number	Ø	Icon
G7915 50	1/2"	6
G7915 62	5/8"	6
G7915 75	3/4"	6



Tap Connector - Threaded Male

Ideal for converting a female threaded tap or other equipment such as jet washers to connect to a female hose coupling.

Item Number	Ø	Icon
G7916 50	1/2"	6
G7916 75	3/4"	6



Tap Connector - 2 Way

For 3/4" external-threaded taps. Two outlets each featuring a cut off valve that can be individually closed for convenience.

Item Number	Icon
G7918	6



Tap Connector - Push-on

Tap connector for smooth taps. (Not suitable for high water pressures).

Item Number	i	📦
G7919	Standard bore (10 - 20mm)	3
G7928	Large bore (20 - 30mm)	3



Hose Repairer

Secure screw down hose connector for permanently joining two hoses or rejoining a hose when a damaged section has been cut out.

Item Number	∅	📦
G7924	1/2"	6
G7932	3/4"	6

HOSE ACCESSORIES



Adjustable Spray Nozzle

Item Number	📦
G7912	6



Adjustable Spray Gun

Ergonomic design for comfort. Lockable on/off trigger for convenience.

Item Number	📦
G7943	3



Hose Connector Display

CONTENTS:

12 x hose connectors: female (1/2").
 6 x hose connectors: male (1/2"), male & female, double male, triple male & water stop (1/2"), 6 x tap connectors: threaded female (1/2"), threaded female (5/8") & threaded female (3/4"), 3 x tap connectors: threaded male (1/2"), threaded male (3/4"), two-way (3/4"), push-on (standard bore) & push-on (large bore), 6 x hose repairers (1/2") and 6 x adjustable spray guns. 6 x adjustable spray nozzles.

Item Number		
G7900ALS	Stock, stand & header	1



Rose Spray

Gentle spray pattern for damage free watering of delicate plants. On/off volume control.

Item Number		
G7945	900mm / 36"	1



Lawn Sprinkler - Oscillating

Covers 200m² at a 5 bar pressure. Adjustable to 4 modes of spread: full, right, left or centre.

Item Number	
G7756BI	1

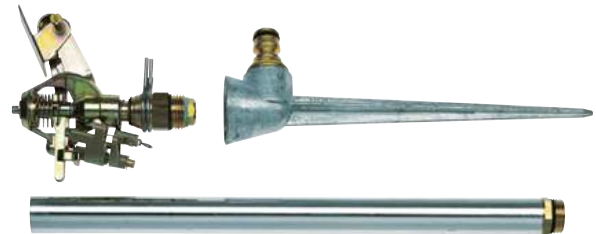

Lawn Sprinkler - Pulse Jet

Covers 450m² at a minimum pressure of 1.2 bar. Adjustable watering arc for full circle or partial segment coverage.

Item Number	
G7755BI	1



Spare 'O' Rings

Item Number		
G7980	Packet of 20	6

HOSE PIPES



Eco-Flex Hose Pipes

Quality 1/2" bore hose pipe ideal for general gardening/household use. Patented inner ribbed construction for greater kink resistance. Polyester reinforcement and PVC outer for extra strength and durability. Burst pressure 25 bar.

Item Number	↔	🏷️	📦
G7620 15	15m	1.8kg	10
G7620 30	30m	3.4kg	5

Multi-Flex Hose Pipes 1/2"

High quality, triple layered, polyester reinforced for extra strength & resistance to twisting and stretching. Abrasion resistant PVC outer layer for long life. UV stable. Burst pressure 28 bar.

Item Number	↔	∅	📦
G7621 15	15m	13mm / 1/2"	1
G7621 30	30m	13mm / 1/2"	1
G7621 50	50m	13mm / 1/2"	1



Pro-Flex Hose Pipes - 1/2" & 3/4"

Item Number	↔	∅	📦
G7625 15	15m	13mm / 1/2"	1
G7625 30	30m	13mm / 1/2"	1
G7625 50	50m	13mm / 1/2"	1
G7625 75	75m	13mm / 1/2"	1
G7626 15	15m	19mm / 3/4"	1
G7626 30	30m	19mm / 3/4"	1
G7626 50	50m	19mm / 3/4"	1

PRO-FLEX HOSE PIPES

1/2" & 3/4"



- 1 Premium quality, triple layered, polyester reinforced for extra strength & resistance to twisting and stretching
- 2 Heavy duty, abrasion resistant PVC outer layer for superior elasticity at low temperatures
- 3 UV stable
- 4 Burst pressure 35 bar



**SENSOPLUS ESD
PLIERS & CUTTERS**

172-176

XONIC ESD

197-198

OTHER

205

**PRECISION
PLIERS & CUTTERS**

177-181

PRECISION SCREWDRIVERS

199-201

ECOTRONIC ESD

182-184

**PRECISION CERAMIC
TRIMMERS**

201-202

CARBOFIB ESD

184-185

PLASTIC TRIMMERS

202

PRECISION TWEEZERS

185-191

WIRE STRIPPERS

203

PRECISION ESD TWEEZERS

191-194

MIRRORS

204

TRITON ESD

194-196

SOLDERING

205

ESD & PRECISION





ESD & PRECISION TOOLS



WHAT IS ESD?

ESD stands for Electro Static Discharge.

The C.K ESD & Precision range is designed specifically for electronics professionals and technicians that require products of the highest quality for ultra fine work.

Electrostatic energy can build up rapidly on a person or object. If two electrically charged objects are brought into contact with each other, a spark may jump from one object to the other in a fast electrostatic discharge.

This rapid discharge of electrostatic energy can cause damage to electronic components, particularly during the assembly and maintenance of electronic equipment.

C.K ESD tools ensure that electrostatic energy is released in a controlled manner thereby preventing sparks from developing.

PRECISION BOX JOINT



MIRROR POLISHED SURFACE



SPOT WELDED DOUBLE LEAF SPRINGS



The C.K ESD range is fully compliant with IEC 61340-5-1 ensuring safe use on sensitive equipment.

CUTTING EDGES

The geometry of the cutting blade determines both the performance and lifetime of the product. A sharper cutting edge reduces 'cutting shock', the energy transmitted to the wire during the cutting process that can cause damage to sensitive components. There is a trade-off however, the sharper the cutting edges, the quicker the blade will wear. The cutting capacity will also be reduced.

KEY

MB	Mini Bevel cut
F	Full Flush cut
EF	Extra Full Flush cut
SM	Smooth jaws
SE	Serrated jaws
CF	Carbon-fibre tips and SA-steel
SA	Stainless steel (No. 4435 / AISI 316)
S	Stainless steel
C	Carbon steel, hardened
SA ESD	Stainless steel, ESD-safe black, epoxy coating
○	Piano Ømm AWG
●	Hard Ømm AWG
◐	Medium/Hard Ømm AWG
◑	Soft Ømm AWG





SENSOPLUS ESD DISSIPATIVE PRECISION PLIERS & CUTTERS

- 1 Special alloy steel, drop forged, hardened and tempered for exceptional strength and durability
- 2 Precision box joint construction for permanent, adjustment free jaw alignment
- 3 Induction hardened jaws for outstanding long term performance
- 4 Mirror polished surface eliminates the risk of damage from flaking chrome
- 5 Spot welded double leaf springs for consistent, repetitive action
- 6 Ergonomically designed dual component handles for increased comfort and control
- 7 Fully ESD compliant for safe use on sensitive electronic components



SENSOPLUS ESD PLIERS & CUTTERS



3779D ESD Side Cutters

Tungsten carbide blades for outstanding cutting life.

IEC 61340 5.1 & 5.2

Item Number					
T3779D 115	2.0 / 12	1.0 / 18	0.6 / 22	125mm / MB	1



3787D ESD Side Cutters

Tungsten carbide blades for outstanding cutting life.

IEC 61340 5.1 & 5.2

Item Number					
T3787DF 115	1.8 / 13	0.8 / 20	0.4 / 22	125mm / F	1



3760D ESD Oblique Cutters

Tungsten carbide blades for outstanding cutting life.

IEC 61340 5.1 & 5.2

Item Number					
T3760DF 110	2.0 / 12	1.0 / 18	0.6 / 22	120mm / F	1



3773D ESD Side Cutters

IEC 61340 5.1 & 5.2

Item Number					
T3773D 115	1.5 / 15	1.0 / 18	0.4 / 26	125mm / MB	1
T3773DF 115	1.5 / 15	1.0 / 18	-	125mm / F	1
T3773DEF115	1.5 / 15	0.8 / 20	-	125mm / EF	1



3781D ESD Side Cutters

IEC 61340 5.1 & 5.2

Item Number					
T3781D 115	1.5 / 15	1.0 / 18	0.3 / 28	125mm / MB	1
T3781DF 115	1.5 / 15	1.0 / 18	-	125mm / F	1
T3781DEF115	1.5 / 15	0.8 / 20	-	125mm / EF	1



3880D ESD Side Cutters

IEC 61340 5.1 & 5.2

Item Number					
T3880DF 110	1.5 / 15	0.8 / 20	-	120mm / F	1
T3880DEF 110	1.0 / 18	0.6 / 22	-	120mm / EF	1



3780D ESD Side Cutters

IEC 61340 5.1 & 5.2

Item Number					
T3780DF 110	1.5 / 15	0.8 / 20	-	120mm / F	1
T3780DEF 110	1.0 / 18	0.6 / 22	-	120mm / EF	1



3782D ESD Side Cutters

Wire catch facility to prevent waste material causing damage to sensitive equipment.

IEC 61340 5.1 & 5.2

Item Number					
T3782D 115	1.5 / 15	1.0 / 18	0.4 / 26	125mm / MB	1
T3782DEF 115	1.5 / 15	0.8 / 20	-	125mm / EF	1



3778D ESD Oblique Cutters

IEC 61340 5.1 & 5.2

Item Number					
T3778DF	1.6 / 14	1.0 / 18	0.3 / 28	120mm / F	1



3766D ESD Side Cutters

IEC 61340 5.1 & 5.2

Item Number					
T3766DF 110	1.5 / 15	0.8 / 20	-	120mm / F	1
T3766DEF 110	1.5 / 15	0.6 / 22	-	120mm / EF	1
T3766DEF 120	1.0 / 18	0.6 / 22	-	125mm / EF	1



3871D ESD Oblique Tip Cutters

Very slim, pointed jaws.

IEC 61340 5.1 & 5.2

Item Number					
T3871DF 120	0.8 / 20	0.6 / 22	-	130mm / F	1



3799D ESD Oblique Cutters

Straight head.

IEC 61340 5.1 & 5.2

Item Number					
T3799DF 110	1.2 / 16	1.0 / 18	0.4 / 26	120mm / F	1
T3799DEF 110	1.0 / 18	0.8 / 20	-	120mm / EF	1



3775D ESD Side Cutters

IEC 61340 5.1 & 5.2

Item Number					
T3775D	2.0 / 12	1.5 / 15	0.7 / 21	120mm / MB	1



3786D ESD Oblique Tip Cutters

IEC 61340 5.1 & 5.2

Item Number					
T3786DF 120	0.8 / 20	0.6 / 22	-	130mm / F	1



3784D ESD Top Cutters

Laid-on joint.

IEC 61340 5.1 & 5.2

Item Number					
T3784DF	0.8 / 20	0.6 / 22	-	130mm / F	1



3776D ESD Top Cutters

IEC 61340 5.1 & 5.2

Item Number					
T3776DEF 115	2.0 / 12	1.6/14	-	115mm / EF	1



3767D ESD Snipe Nose Pliers

Bent nose.

IEC 61340 5.1 & 5.2

Item Number		
T3767D 120	130mm / SM	1



3772D ESD Snipe Nose Pliers

IEC 61340 5.1 & 5.2

Item Number		
T3772D 120	130mm / SM	1
T3772 1D120	130mm / SE	1



3769D ESD Snipe Nose Pliers

Bent nose.

IEC 61340 5.1 & 5.2

Item Number		
T3769D 150	155mm / SE	1



3777D ESD Snipe Nose Pliers

IEC 61340 5.1 & 5.2

Item Number		
T3777D 150	155mm / SE	1



3770D ESD Flat Nose Pliers

IEC 61340 5.1 & 5.2

Item Number		
T3770D 120	130mm / SM	1
T3770 1D120	130mm / SE	1



3783D ESD Needle Nose Pliers

IEC 61340 5.1 & 5.2

Item Number	i	
T3783D	155mm / SM	1



3771D ESD Round Nose Pliers

IEC 61340 5.1 & 5.2

Item Number	i	
T3771D 120	130mm / SM	1



ESD Pliers Set - 6 Piece

CONTENTS:

Side cutter T3773D, Side cutter T3880DF, Side cutter T3766DF, Oblique cutter T3786DF, Snipe nose plier T3772D and Flat nose plier T3770D.



Item Number	
T3703D	1



Zip Wallet

Item Number	i	
T3703DL	Empty zip wallet	1

ESD Tool Kit - 14 Piece

CONTENTS:

Side cutter T3773D, Snipe nose plier T3772D, Positioning tweezer T2334, Precision tweezer T2343 and 1 x screwdriver, slotted, sizes: 1.5 x 60, 1.8 x 60, 2.5 x 60, 2.5 x 75, 3.0 x 100 & 4.0 x 100mm; PH, sizes: 000 x 60, 00 x 60, 0 x 60 & 1 x 80mm.

IEC 61340 5.1 & 5.2

Item Number	i	
T3707DX	14 piece hand tool kit	1



CLASSIC PRECISION PLIERS & CUTTERS

- 1 Special alloy steel, drop forged, hardened and tempered for exceptional strength and durability
- 2 Precision box joint construction for permanent, adjustment free jaw alignment
- 3 Induction hardened jaws for outstanding long term performance
- 4 Mirror polished surface eliminates the risk of damage from flaking chrome
- 5 Spot welded double leaf springs for consistent, repetitive action
- 6 PVC handles for comfort and grip



CLASSIC™

PRECISION PLIERS & CUTTERS



CONTENTS:

Side cutter T3773, Side cutter T3780F, Oblique cutter T3799F, Snipe nose plier T3772 and Snipe nose.

Item Number		
T3703	Empty zip wallet	1



3779 Side Cutters

Tungsten carbide blades for outstanding cutting life.

Item Number					
T3779	2.0 / 12	1.0 / 18	0.6 / 22	125mm / MB	1



3775 Side Cutters

Item Number					
T3775	2.0 / 12	1.5 / 15	0.7 / 21	135mm / MB	1
T3775EF	2.0 / 12	1.3 / 18	-	135mm / EF	1



3773 Side Cutters

Item Number					
T3773	1.5 / 15	1.0 / 18	0.4 / 26	115mm / MB	1
T3773F	1.5 / 15	1.0 / 18	-	115mm / F	1
T3773EF	1.5 / 15	0.8 / 20	-	115mm / EF	1



3780 Side Cutters

Item Number					
T3780F	1.5 / 15	0.8 / 20	-	110mm / F	1
T3780EF	1.5 / 15	0.6 / 22	-	110mm / EF	1



3880 Side Cutters

Item Number					
T3880F	1.5 / 15	0.8 / 20	-	110mm / F	1



3774 Side Cutters

Laid-on joint.

Item Number					
T3774	1.5 / 15	1.0 / 18	0.4 / 26	120mm / MB	1



3781 Side Cutters

Item Number					
T3781	1.5 / 15	1.0 / 18	0.3 / 28	115mm / MB	1



3778 Oblique Cutters

Wide head, long blades.

Item Number					
T3778F	1.6 / 14	1.2 / 16	0.5 / 24	120mm / F	1



3799 Oblique Cutters

Straight head.

Item Number					
T3799F	1.2 / 16	1.0 / 18	0.4 / 26	110mm / F	1



3772 Snipe Nose Pliers

Item Number		
T3772	120mm / SM	1
T3772 1	120mm / SE	1



3776 Top Cutters

Wide head, long blades.

Item Number					
T3776F	1.6 / 14	1.2 / 16	0.5 / 24	115mm / F	1
T3776EF 5	2.0 / 12	1.6 / 14	-	130mm / EF	1



3777 Snipe Nose Pliers

Long nose.

Item Number		
T3777	145mm / SE	1



3786 Oblique Tip Cutters

Item Number					
T3786F 4	0.8 / 20	0.6 / 22	-	120mm / FF	1



3767 Snipe Nose Pliers

Bent nose.

Item Number		
T3767	130mm / SM	1



3769 Snipe Nose Pliers

Bent nose.

Item Number	i	📦
T3769	145mm / SE	1



3783 Needle Nose Pliers

Item Number	i	📦
T3783	145mm / SM	1



3770 Flat Nose Pliers

Item Number	i	📦
T3770	120mm / SM	1



3771 Round Nose Pliers

Item Number	i	📦
T3771	120mm / SM	1



3789 Flat Nose Pliers

Item Number	i	📦
T3789	145mm / SM	1



3796 Wire Stripping Pliers

Laid-in joint.

Item Number	∅	i	📦
T3796 5	0.1 - 0.8mm	140mm	1



ECOTRONIC ESD DISSIPATIVE PLIERS & CUTTERS

- 1 Fully ESD compliant for safe use on sensitive electronic components
- 2 Strong and secure riveted joint
- 3 Black oxidised finish to protect against corrosion
- 4 Ergonomic dual component handles for increased comfort and control



Pliers Set - 6 Piece

CONTENTS:

Side cutter T3773, Side cutter T3780F, Oblique cutter T3799F, Snipe nose plier T3772, Snipe nose plier T3767 and Flat nose plier T3770.

Item Number		
T3703	6 piece pliers set	1

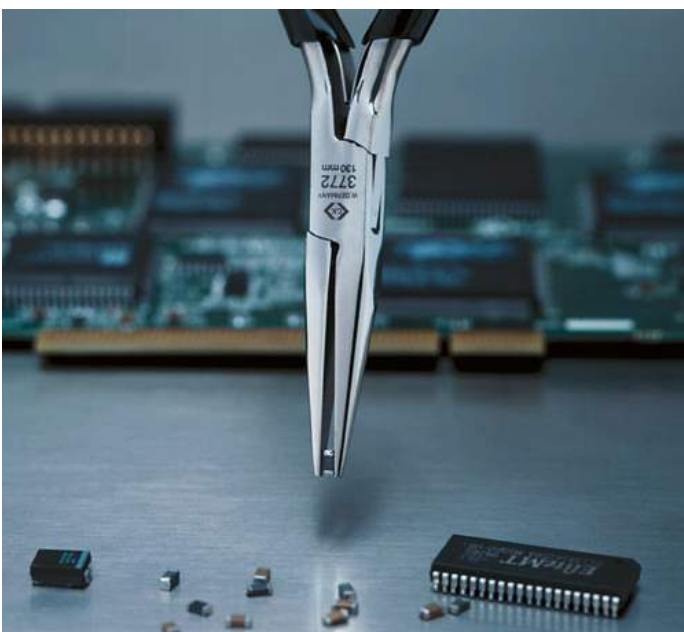



ECOTRONIC ESD



3883 ESD Side Cutters

Micro, tapered cutting head.

IEC 61340 5.1 & 5.2

Item Number			
T3883	1.3 / 16	132mm / EF	6



3886 ESD Side Cutters

Slim, tapered and relieved head.

IEC 61340 5.1 & 5.2



Item Number	
T3886	6



3884 ESD Side Cutters

Reverse action cutting blades. Cutting DIP pins on integrated circuits.

IEC 61340 5.1 & 5.2

Item Number			
T3884	1.3 / 16	132mm / EF	6



3887 ESD Side Cutters

IEC 61340 5.1 & 5.2



Item Number			
T3887	1.6 / 14	136mm / EF	6



3885 ESD Side Cutters

Slim, tapered cutting head.

IEC 61340 5.1 & 5.2



Item Number			
T3885	1.3 / 16	139mm / EF	6



3888 ESD Side Cutters

Tapered & Relieved head.

IEC 61340 5.1 & 5.2

Item Number			
T3888	1.6 / 14	135mm / EF	6



3889 ESD Snipe Nose Pliers

Long nose.
IEC 61340 5.1 & 5.2

Item Number		
T3889	152mm / SE	6



3892 ESD Snipe Nose Pliers

Bent tips.
IEC 61340 5.1 & 5.2

Item Number		
T3892	152mm / SE	6



3890 ESD Snipe Nose Pliers

Short nose.
IEC 61340 5.1 & 5.2

Item Number		
T3890	145mm / SM	6



3893 ESD Wire Stripping Pliers

Six pre-set blade pairs: 0.2, 0.3, 0.4, 0.5, 0.8mm.
IEC 61340 5.1 & 5.2

Item Number			
T3893	3 / 8	168mm	6



3891 ESD Flat Nose Pliers

IEC 61340 5.1 & 5.2

Item Number		
T3891	145mm / SM	6



3894 ESD Wire Stripping Pliers

Six pre-set blade pairs: 0.4, 0.5, 0.6, 0.8, 1.3mm.
IEC 61340 5.1 & 5.2

Item Number			
T3894	3 / 8	152mm	6



CARBOFIB ESD DISSIPATIVE TWEZZERS

- 1 Carbon fibre tips allow for safe handling of highly sensitive electrical components
- 2 High grade, stainless steel bow - acid and corrosion resistant
- 3 Precision welded joint for consistent, repetitive action
- 4 Fully ESD compliant for safe use on sensitive electronic components
- 5 Anti-magnetic to prevent electro-magnetic damage
- 6 Heat resistant up to 270°C for safe use



3895 ESD Wire Stripping Pliers

Six pre-set blade pairs: 0.8, 1.0, 1.3, 1.6, 2.0, 2.6mm.

IEC 61340 5.1 & 5.2

Item Number			
T3895	3 / 8	152mm	6

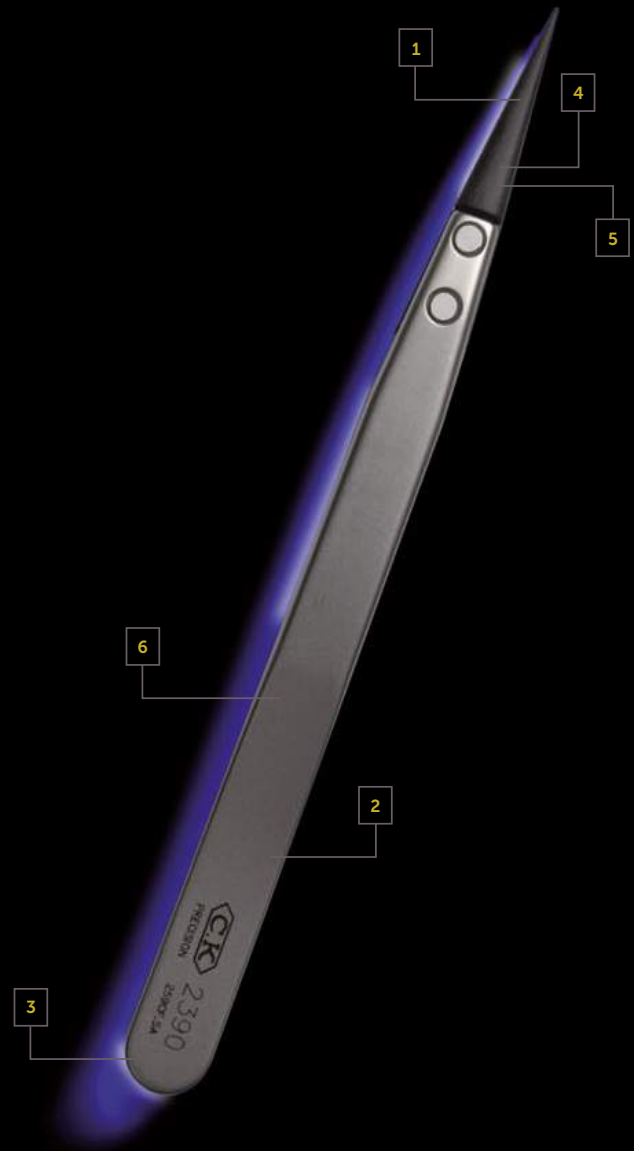

CARBOFIB ESD



2390 ESD Positioning Tweezers

Fine tips.

IEC 61340 5.1 & 5.2

Item Number			TYPE	
T2390	130mm	CF	259CF	1



2391 ESD Positioning Tweezers

Fine, extra slim tips.

IEC 61340 5.1 & 5.2

Item Number			TYPE	
T2391	130mm	CF	5CF	1



2392 ESD Positioning Tweezers

Round tips, 2mm wide.

IEC 61340 5.1 & 5.2

Item Number			TYPE	
T2392	130mm	CF	249CF	1



**PRECISION
TWEEZERS**

- 1 Manufactured using high grade, stainless steel - acid and corrosion resistant
- 2 Anti-magnetic to prevent electro-magnetic damage
- 3 Precision welded joint for consistent, repetitive action
- 4 Fine polished for a non-reflective matt finish

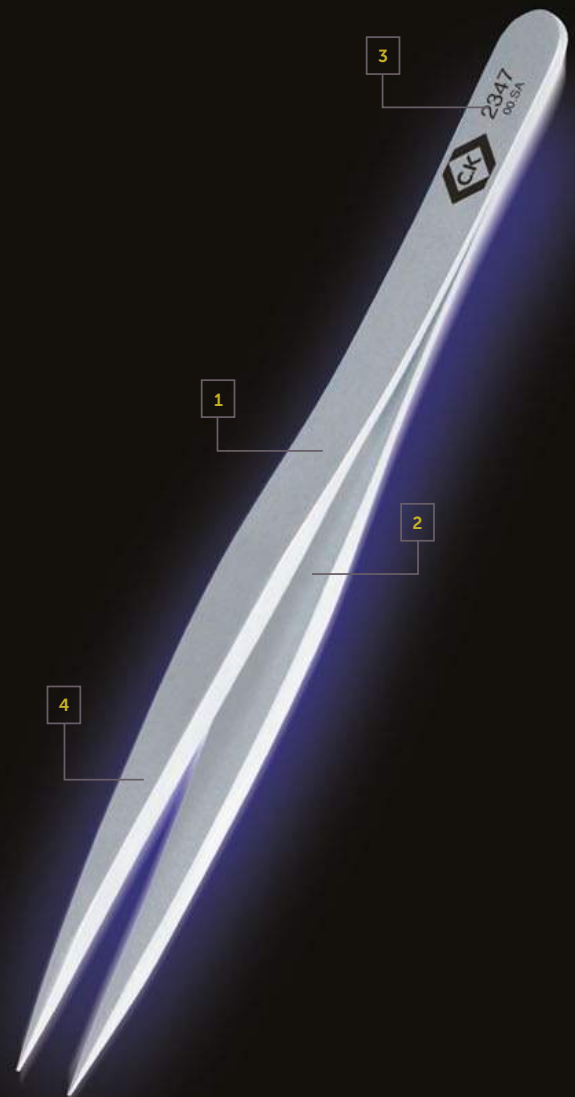

precision

PRECISION TWEEZERS



2346 Precision Tweezers

Straight, fine tips.

Item Number	←→	i	TYPE	📦
T2346	127mm	SA	AA.SA	1



2330 Precision Tweezers

Superfine tips, angled at 60°.

Item Number	←→	i	TYPE	📦
T2330	110mm	SA	5B.SA	1



2347 Precision Tweezers

Strong, thick, flat edges, straight.

Item Number	←→	i	TYPE	📦
T2347	123mm	SA	00.SA	1



2331 Precision Tweezers

Superfine tips, offset & angled at 60°.

Item Number	←→	i	TYPE	📦
T2331	115mm	SA	5C.SA	1



2348 Precision Tweezers

Flat, sharp, fine tips.

Item Number	←→	i	TYPE	📦
T2348	122mm	SA	2.SA	1



2341 Precision Tweezers

Superfine tips, straight.

Item Number	←→	i	TYPE	📦
T2341	110mm	SA	5B.SA	1



2340 Precision Tweezers

Fine, sharp tips, straight.

Item Number			TYPE	
T2340	110mm	SA	3C.SA	1



2381 Precision Tweezers

Flat, blunt tips, finely milled inside.

Item Number			TYPE	
T2381	120mm	SA	OOD.SA	1



2343 Precision Tweezers

Fine tips, straight.

Item Number			TYPE	
T2343	130mm	SA	MM.SA	1



2359 Positioning Tweezers

Fine, bent tips, fine cross-cut inside.

Item Number			TYPE	
T2359	150mm	SA	22.SA	1



2339 Precision Tweezers

Fine tips, curved.

Item Number			TYPE	
T2339	110mm	SA	7.SA	1



2360 Positioning Tweezers

Flat, round tips, straight.

Item Number			TYPE	
T2360	120mm	SA	2A.SA	1



2364 Flat tip Tweezers

Spatula square flat tips.

Item Number	←→	i	TYPE	📦
T2364	105mm	SA	127.SA	1



2336 Positioning Tweezers

Grooved tips angled at 30°. For cylindrical devices up to 1mm Ø.

Item Number	←→	i	TYPE	📦
T2336	120mm	SA	SM115.SA	1



2349 Cross pattern Tweezers

Reverse action. For SOT-packages, monolithic chip capacitors, etc.

Item Number	←→	i	TYPE	📦
T2349	120mm	SA	X104.SA	1



2351 Positioning Tweezers

Tips round inside. For cylindrical devices up to 1mm Ø.

Item Number	←→	i	TYPE	📦
T2351	115mm	SA	582.SA	1



2334 Positioning Tweezers

For SOT-packages, monolithic chip capacitors, etc.

Item Number	←→	i	TYPE	📦
T2334	120mm	SA	SM104.SA	1



2354 Positioning Tweezers

Tips round inside. For cylindrical devices up to 2mm Ø.

Item Number	←→	i	TYPE	📦
T2354	115mm	SA	578.SA	1



2316 Precision Tweezers

Fine, straight tips.

Item Number			
T2316	105mm	SA (18/10)	1



2319 Precision Tweezers

Fine, straight extra long tips.

Item Number				
T2319	120mm	S	Note item is not anti-magnetic	1



2317 Precision Tweezers

Fine, bent tips.

Item Number			
T2317	105mm	SA (18/10)	1



2301 Universal Tweezers

Fine, blunt tips, 2mm wide, finely milled inside. Polished and fine nickel plated.

Item Number				
T2301	115mm	C		1



2318 Precision Tweezers

Fine, straight extra long tips.

Item Number			
T2318	130mm	SA (18/10)	1



2302 Universal Tweezers

Fine, blunt tips, 2mm wide, finely milled inside. Polished and black coated.

Item Number				
T2302	115mm	C		1



2307 Universal Tweezers

Blunt tips, 3.5mm wide, finely milled inside. Polished and fine nickel plated.

Item Number	↔	i	📦
T2307	145mm	C	1



2309 Universal Tweezers

Blunt tips, 2mm wide, fine cross cut inside. Polished and fine nickel plated.

Item Number	↔	i	📦
T2309	140mm	C	1



2308 Universal Tweezers

Blunt tips, 3.5mm wide, finely milled inside. Polished and black coated.

Item Number	↔	i	📦
T2308	145mm	C	1



2314 Universal Tweezers

Fine, blunt tips, bent, finely milled inside. With guide pin. Polished and fine nickel plated.

Item Number	↔	i	📦
T2314	150mm	C	1



2308A Universal Tweezers

Blunt tips, 3.5mm wide, finely milled inside. Polished and PVC coated.

Item Number	↔	i	📦
T2308A	145mm	C	1



2315 Universal Tweezers



Fine, blunt tips, bent, finely milled inside. With guide pin. Polished and black coated.

Item Number	↔	i	📦
T2315	155mm	C	1



2327 Radio Tweezers

Fine, blunt tips, 2mm wide, straight. Finely milled inside. Polished and fine nickel plated.

Item Number			
T2327	155mm	C	1



2345A Ceramic Tweezers



Fine, straight tips.

Item Number			TYPE	
T2345A	140mm	CER	73 MZ SA	1



2328 Radio Tweezers



Fine, blunt tips, 2mm wide, bent. Finely milled inside. Polished and fine nickel plated.

Item Number			
T2328	155mm	C	1



2313A Cross Pattern Tweezers

Reverse action. Soldering tweezers with finger pads to protect against heat. Fine, bent tips, 2.5mm wide. Polished and fine nickel plated.

Item Number			
T2313A	160mm	C	1



PRECISION ESD TWEEZERS

- 1 Manufactured using high grade, stainless steel - acid and corrosion resistant
- 2 ESD-safe, black epoxy coating with a surface resistance of 10^5 - 10^6
- 3 Anti-magnetic to prevent electro-magnetic damage
- 4 Precision welded joint for consistent, repetitive action
- 4 Fine polished, matt finish on the tips



precision ESD

PRECISION ESD TWEEZERS



2340D ESD Precision Tweezers

Extremely fine, sharp, straight tips.

IEC 61340 5.1 & 5.2

Item Number	←→	i	TYPE	📦
T2340D	110mm	SA ESD	3C. SA ESD	1



2347D ESD Precision Tweezers

Strong, thick, flat edges, straight.

IEC 61340 5.1 & 5.2

Item Number	←→	i	TYPE	📦
T2347D	122mm	SA ESD	00.SA ESD	1



2341D ESD Precision Tweezers

Superfine tips, straight.

IEC 61340 5.1 & 5.2

Item Number	←→	i	TYPE	📦
T2341D	110mm	SA ESD	5.SA ESD	1



2348D ESD Precision Tweezers

Flat, sharp, fine tips.

IEC 61340 5.1 & 5.2

Item Number	←→	i	TYPE	📦
T2348D	120mm	SA ESD	2.SA ESD	1



2346D ESD Precision Tweezers

Straight, fine tips.

IEC 61340 5.1 & 5.2

Item Number	←→	i	TYPE	📦
T2346D	127mm	SA ESD	AA.SA ESD	1



2360D ESD Precision Tweezers

Flat, fine, round tips. For handling delicate or small components.

IEC 61340 5.1 & 5.2

Item Number	←→	i	TYPE	📦
T2360D	123mm	SA ESD	2A.SA ESD	1



2361D ESD Precision Tweezers

Extra fine tips, curved and strong.

IEC 61340 5.1 & 5.2

Item Number			TYPE	
T2361D	120mm	SA ESD	7A.SA ESD	1



2368D ESD Precision Tweezers

Slim, long, superfine tips. Provides extended reach and access in confined areas.

IEC 61340 5.1 & 5.2

Item Number			TYPE	
T2368D	140mm	SA ESD	SS.SA ESD	1



2362D ESD Positioning Tweezers

For positioning and soldering 1mm wide components, 45° tips.

IEC 61340 5.1 & 5.2

Item Number			TYPE	
T2362D	120mm	SA ESD	12.SA ESD	1



2369D ESD Precision Tweezers

Slim, straight, fine tips.

IEC 61340 5.1 & 5.2

Item Number			TYPE	
T2369D	120mm	SA ESD	1.SA ESD	1



2363D ESD Positioning Tweezers

Grooved tips for positioning and soldering 1mm wide components.

IEC 61340 5.1 & 5.2

Item Number			TYPE	
T2363D	120mm	SA ESD	13.SA ESD	1



2370D ESD Precision Tweezers

Flat, fine tips, curved. For handling delicate or small components. Tip angle facilitates wafer tray loading.

IEC 61340 5.1 & 5.2

Item Number			TYPE	
T2370D	117mm	SA ESD	2AB.SA ESD	1



TRITON ESD DISSIPATIVE SCREWDRIVERS

- 1 Ergonomic tri-lobe handle design for comfort and effective delivery of torque
- 2 Fully ESD compliant for safe use on sensitive electronic components
- 3 Toughened alloy steel blade for exceptional strength and durability
- 4 Black anti-peel finish eliminates the risk of damage from flaking chrome
- 5 Handle injection moulded directly to blade giving the ultimate bond for increased reliability and durability
- 6 Precision machined tip for an exact screw fit and damage free screwdriving



2379D ESD Precision Tweezers

Very sharp, fine tips.

IEC 61340 5.1 & 5.2

Item Number	←→	i	TYPE	☐
T2379D	120mm	SA ESD	3.SA ESD	1



2388D ESD Precision Tweezers

Extremely fine, straight tips.

IEC 61340 5.1 & 5.2

Item Number	←→	i	TYPE	☐
T2388D	110mm	SA ESD	4A.SA ESD	1



2389D ESD Precision Tweezers

Oblique, extra fine tips. For improved visibility whilst working.

IEC 61340 5.1 & 5.2

Item Number	←→	i	TYPE	☐
T2389D	120mm	SA ESD	5A.SA ESD	1

TRITON ESD



4725 ESD Slotted Screwdrivers

DIN ISO 2380, IEC 61340 5.1 & 5.2

Item Number					
T4725ESD 03	3mm 1/8"	75mm 3"	0.5mm 0.02"	70mm 2 3/4"	6
T4725ESD 04	3mm 1/8"	100mm 4"	0.5mm 0.02"	80mm 3 1/8"	6
T4725ESD 41	4mm 5/32"	100mm 4"	0.8mm 0.031"	90mm 3 1/2"	6
T4725ESD 05	5mm 3/16"	125mm 5"	0.8mm 0.031"	90mm 3 1/2"	6
T4725ESD 10	5mm 3/16"	250mm 10"	0.8mm 0.031"	90mm 3 1/2"	6

4722 ESD Phillips Screwdrivers

DIN ISO 2380, IEC 61340 5.1 & 5.2

Item Number					
T4722ESD 0	PH0	3.5mm 9/64"	60mm 2 3/8"	70mm 2 3/4"	6
T4722ESD 1	PH1	5.0mm 3/16"	80mm 3 1/8"	90mm 3 1/2"	6
T4722ESD 13	PH1	5.0mm 3/16"	300mm 12"	90mm 3 1/2"	6
T4722ESD 2	PH2	6.0mm 7/32"	100mm 4"	100mm 4"	6
T4722ESD 23	PH2	6.0mm 7/32"	300mm 12"	100mm 4"	6



4723 ESD PZD/SDV® Screwdrivers

DIN ISO 2380, IEC 61340 5.1 & 5.2

Item Number					
T4723ESD 0	PZ0	3.5mm 9/64"	60mm 2 3/8"	70mm 2 3/4"	6
T4723ESD 1	PZ1	5.0mm 3/16"	80mm 3 1/8"	90mm 3 1/2"	6
T4723ESD 2	PZ2	6.0mm 7/32"	100mm 4"	100mm 4"	6

4718 ESD Screwdrivers - TX Tamperproof

IEC 61340 5.1 & 5.2

Item Number					
T4718ESD 08	T 08	3.0mm 1/8"	70mm 2 3/4"	80mm 3 1/8"	6
T4718ESD 0820	T 08	3.0mm 1/8"	200mm 8"	80mm 3 1/8"	6
T4718ESD 09	T 09	3.0mm 1/8"	70mm 2 3/4"	80mm 3 1/8"	6
T4718ESD 10	T 10	3.0mm 1/8"	80mm 3 1/8"	90mm 3 1/2"	6
T4718ESD 1030	T 10	3.0mm 1/8"	300mm 12"	90mm 3 1/2"	6
T4718ESD 15	T 15	3.5mm 9/64"	80mm 3 1/8"	90mm 3 1/2"	6
T4718ESD 1530	T 15	3.5mm 9/64"	300mm 12"	90mm 3 1/2"	6
T4718ESD 20	T 20	4.0mm 5/32"	90mm 3 1/2"	90mm 3 1/2"	6



4583 ESD Bit Holder

IEC 61340 5.1 & 5.2

Item Number				
T4582ESD	E6.3 1/4"	125mm 5"	100mm 4"	6



4730 ESD Screwdriver Set - 5 Piece TX

For Torx® Tamperproof screws.

CONTENTS:
1 x TX, sizes: 8, 9, 10, 15 & 20.

Item Number	
T4730ESD	3



4741 ESD Screwdriver Set - 5 Piece SL/PZ

CONTENTS:
1 x slotted, sizes: 3 x 75, 3 x 100 & 5 x 135mm and 1 x PZ, sizes: 0 x 60, 1 x 80 & 2 x 100mm.

Item Number	
T4741ESD	3



4741S ESD Screwdriver Set - 6 Piece SL/PH

CONTENTS:
1 x slotted, sizes: 3 x 75, 3 x 100 & 5 x 125mm and 1 x PH, sizes: 0 x 60, 1 x 80 & 2 x 100mm.

Item Number	
T4741SESD	3



4797 ESD Screwdriver Set - 6 Piece SL/PH/TX

Long reach screwdrivers.

CONTENTS:
1 x slotted, size: 5 x 250mm, 1 x PH, sizes: 1 x 300 & 2 x 300mm and 1 x TX, sizes: 8 x 200, 10 x 300 & 15 x 300mm.

Item Number	
T4797ESD	3



XONIC ESD DISSIPATIVE PRECISION SCREWDRIVERS

- 1 Ergonomically designed handle with hollow rotating cap for ease of use and precise control
- 2 Premium quality alloy steel blade for exceptional strength and durability
- 3 Precision machined tip for an exact screw fit and damage free screwdriving
- 4 Black anti-peel tips eliminates the risk of damage from flaking chrome
- 5 Fully ESD compliant for safe use on sensitive electronic components



XONIC ESD



4880X ESD Slotted Screwdrivers

IEC 61340 5.1 & 5.2

Item Number					
T4880XES08	0.8mm 1/32"	60mm 2 3/8"	0.20mm 0.008"	97mm 3 13/16"	10
T4880XES12	1.2mm 3/64"	60mm 2 3/8"	0.25mm 0.010"	97mm 3 13/16"	10
T4880XES15	1.5mm 1/16"	60mm 2 3/8"	0.30mm 0.012"	97mm 3 13/16"	10
T4880XES18	1.8mm 5/64"	60mm 2 3/8"	0.30mm 0.012"	97mm 3 13/16"	10
T4880XES256	2.5mm 3/32"	60mm 2 3/8"	0.40mm 0.016"	97mm 3 13/16"	10
T4880XES257	2.5mm 3/32"	75mm 3"	0.40mm 0.016"	97mm 3 13/16"	10
T4880XES310	3.0mm 1/8"	100mm 4"	0.50mm 0.020"	97mm 3 13/16"	10
T4880XES315	3.0mm 1/8"	150mm 6"	0.50mm 0.020"	97mm 3 13/16"	10
T4880XES410	4.0mm 5/32"	100mm 4"	0.60mm 0.024"	97mm 3 13/16"	10
T4880XES415	4.0mm 5/32"	150mm 6"	0.60mm 0.024"	97mm 3 13/16"	10



4875X ESD PZD/SDV® Screwdrivers

IEC 61340 5.1 & 5.2

Item Number					
T4875X ESD	PZ0	3.0mm 1/8"	60mm 2 3/8"	97mm 3 13/16"	10
T4875X ESD 1	PZ1	4.5mm 11/64"	80mm 3 1/8"	97mm 3 13/16"	10



4882X ESD Phillips Screwdrivers

IEC 61340 5.1 & 5.2

Item Number					
T4882X000ES	PH000	2.5mm 3/32"	60mm 2 3/8"	97mm 3 13/16"	10
T4882X00ESD	PH00	2.5mm 3/32"	60mm 2 3/8"	97mm 3 13/16"	10
T4882X0 ESD	PH0	3.0mm 1/8"	60mm 2 3/8"	97mm 3 13/16"	10
T4882X1 ESD	PH1	4.5mm 11/64"	80mm 3 1/8"	97mm 3 13/16"	10



4877X ESD Torx® Screwdrivers

IEC 61340 5.1 & 5.2

Item Number					
T4877XESD04	T 04	2.5mm 3/32"	50mm 2"	97mm 3 13/16"	10
T4877XESD05	T 05	2.5mm 3/32"	50mm 2"	97mm 3 13/16"	10
T4877XESD06	T 06	3.5mm 9/64"	50mm 2"	97mm 3 13/16"	10
T4877XESD07	T 07	3.5mm 9/64"	50mm 2"	97mm 3 13/16"	10
T4877XESD08	T 08	3.5mm 9/64"	60mm 2 3/8"	97mm 3 13/16"	10



4838X ESD Ball Ended Hexagon Screwdriver

IEC 61340 5.1 & 5.2

Item Number					
T4838XESD15	1.5 1/16"	50mm 2"	2.5mm 3/32"	97mm 3 13/16"	30
T4838XESD20	2.0 5/64"	50mm 2"	2.5mm 3/32"	97mm 3 13/16"	30
T4838XESD25	2.5 1/18"	60mm 2 3/8"	3.0mm 1/8"	97mm 3 13/16"	30
T4838XESD30	3.0 1/8"	60mm 2 3/8"	3.5mm 9/64"	97mm 3 13/16"	30



4840X ESD Nut Driver

IEC 61340 5.1 & 5.2

Item Number					
T4840XESD32	3.2mm 1/8"	60mm 2 3/8"	4mm 5/32"	97mm 3 13/16"	30
T4840XESD35	3.5mm 9/64"	60mm 2 3/8"	4mm 5/32"	97mm 3 13/16"	30
T4840XESD40	4.0mm 5/32"	60mm 2 3/8"	4mm 5/32"	97mm 3 13/16"	30
T4840XESD45	4.5mm 11/64"	60mm 2 3/8"	4mm 5/32"	97mm 3 13/16"	30
T4840XESD50	5.0mm 3/16"	60mm 2 3/8"	4mm 5/32"	97mm 3 13/16"	30
T4840XESD55	5.5mm 7/32"	60mm 2 3/8"	4mm 5/32"	97mm 3 13/16"	30



4883X ESD Screwdriver Set - 7 Piece SL/PH

CONTENTS:

1 x slotted, sizes: 2.5 x 75, 3.0 x 100, 3.0 x 150, 4.0 x 100 & 4.0 x 150mm and 1 x PH, sizes: 0 x 60 & 1 x 80mm.

Item Number	
T4883XESD	1



4884X ESD Screwdriver Set - 4 Piece SL/PH

CONTENTS:

1 x slotted, sizes: 1.8 x 60, 3 x 100 & 4 x 150mm and 1 x PH, size: 0 x 60mm.

Item Number	
T4884X ESD	1



XONIC PRECISION SCREWDRIVERS





- 1 Ergonomically designed handle with hollow rotating cap for ease of use and precise control
- 2 Premium quality chrome vanadium steel blade for exceptional strength and durability
- 3 Precision machined tip for an exact screw fit and damage free screwdriving
- 4 Black anti-peel tips eliminates the risk of damage from flaking chrome
- 5 Tip type colour coding for easy identification



PRECISION SCREWDRIVERS



4880X Slotted Screwdrivers

Item Number					
T4880X 08	2.5mm 3/32"	60mm 2 3/8"	0.20mm 0.008"	97mm 3 13/16"	10
T4880X 12	2.5mm 3/32"	60mm 2 3/8"	0.20mm 0.008"	97mm 3 13/16"	10
T4880X 15	2.5mm 3/32"	60mm 2 3/8"	0.25mm 0.10"	97mm 3 13/16"	10
T4880X 18	2.5mm 3/32"	60mm 2 3/8"	0.30mm 0.012"	97mm 3 13/16"	10
T4880X 256	2.5mm 3/32"	60mm 2 3/8"	0.40mm 0.016"	97mm 3 13/16"	10
T4880X 257	2.5mm 3/32"	75mm 3"	0.40mm 0.016"	97mm 3 13/16"	10
T4880X 310	3.0mm 1/8"	100mm 4"	0.50mm 0.020"	97mm 3 13/16"	10
T4880X 315	3.0mm 1/8"	150mm 6"	0.50mm 0.020"	97mm 3 13/16"	10
T4880X 410	4.0mm 5/32"	100mm 4"	0.80mm 0.031"	97mm 3 13/16"	10
T4880X 415	4.0mm 5/32"	150mm 6"	0.80mm 0.031"	97mm 3 13/16"	10



4882X Phillips Screwdrivers

Item Number					
T4882X 000	PH000	2.5mm 3/32"	60mm 2 3/8"	97mm 3 13/16"	10
T4882X 00	PH00	2.5mm 3/32"	60mm 2 3/8"	97mm 3 13/16"	10
T4882X 0	PH0	3.0mm 1/8"	60mm 2 3/8"	97mm 3 13/16"	10
T4882X 1	PH1	4.5mm 11/64"	80mm 3 1/8"	97mm 3 13/16"	10

XONIC™



4877X Torx® Screwdrivers

Item Number					
T4877X 04	T 04	2.5mm 3/32"	50mm 2"	97mm 3 13/16"	10
T4877X 05	T 05	2.5mm 3/32"	50mm 2"	97mm 3 13/16"	10
T4877X 06	T 06	3.5mm 9/64"	50mm 2"	97mm 3 13/16"	10
T4877X 07	T 07	3.5mm 9/64"	50mm 2"	97mm 3 13/16"	10
T4877X 08	T 08	3.5mm 9/64"	60mm 2 3/8"	97mm 3 13/16"	10
T4877X 09	T 09	4.0mm 5/32"	60mm 2 3/8"	97mm 3 13/16"	10
T4877X 10	T 10	4.0mm 5/32"	80mm 3 1/8"	97mm 3 13/16"	10
T4877X 15	T 15	4.0mm 5/32"	80mm 3 1/8"	97mm 3 13/16"	10



4880X/5 Screwdriver Set - 5 Piece SL/PH

CONTENTS:

1 x slotted, sizes: 2.5 x 75, 3.0 x 100 & 4.0 x 100mm and 1 x PH, sizes: 00 x 60 & 0 x 60mm.

Item Number	
T4880X/5	6



4883X Screwdriver Set - 7 Piece SL/PH

CONTENTS:

1 x slotted, sizes: 2.5 x 75, 3 x 100, 3 x 150, 4 x 100 & 4 x 150mm and 1 x PH, sizes: 0 x 60 & 1 x 80mm.

Item Number	
T4883X	1



4884X Screwdriver Set - 4 Piece SL/PH

CONTENTS:

1 x slotted, sizes: 1.8 x 60, 3.0 x 100 & 4.0 x 150mm and 1 x PH size: 0 x 60mm.

Item Number	
T4884X	1



4874X Screwdriver Set - 7 Piece Hexagon

CONTENTS:

1 x hexagon, sizes: 0.7 x 50, 0.9 x 50, 1.3 x 50, 1.5 x 50, 2.0 x 50, 2.5 x 60 & 3.0 x 60mm.

Item Number	
T4874X	1



4877PX Screwdriver Set - 7 Piece TX

For Torx® screws.

CONTENTS:

1 x TX, sizes: 6, 7, 8, 9, 10, 15 & 20.

Item Number	
T4877PX	10



PRECISION CERAMIC TRIMMERS

- 1 Zirconia ceramic tips - safe trimming of highly sensitive electrical components, highly acid resistant (other than Hydrofluoric), solder repellent and electrically non-conductive
- 2 Heat resistant up to 1000°C for safe use
- 3 Non-magnetic to prevent electro-magnetic damage



4852P Screwdriver Set - 4 Piece Slotted

CONTENTS:

1 x screwdriver, slotted, sizes: 1.0 x 15, 1.6 x 20, 2.0 x 22 & 2.4 x 25mm.

Item Number



T4852P

6



4854P Screwdriver Set - 6 Piece SL/PH

CONTENTS:

1 x screwdriver, slotted, sizes: 1.0 x 15, 1.6 x 20, 2.0 x 22 & 2.4 x 25mm and 1 x PH, sizes: 00 x 25 & 0 x 25mm.

Item Number



T4854P

6



4896 Screwdriver Set - 7 Piece SL/PH/TX

CONTENTS:

Screwdriver handle and 6 double ended interchangeable bits - Slotted 1.5, 2, 3, 4mm; PH000, PH00, PH0, PH1; TX05, TX06, TX07, TX08.

Item Number



T4896

6



precision

PRECISION CERAMIC TRIMMERS



4845 Slotted Trimmer Ceramic

Item Number					
T4845 09	0.9mm 0.35"	15mm 5/8"	0.4mm 0.016"	85mm 3 3/8"	10
T4845 13	1.3mm 0.51"	15mm 5/8"	0.4mm 0.016"	85mm 3 3/8"	10
T4845 18	1.8mm 0.71"	15mm 5/8"	0.4mm 0.016"	85mm 3 3/8"	10
T4845 26	2.6mm 0.102"	15mm 5/8"	0.4mm 0.016"	85mm 3 3/8"	10



4847 Phillips Trimmer Ceramic

Item Number					
T4847	PH 0	2.6mm .102"	15mm 5/8"	85mm 3 3/8"	10
T4847 0	PH 0 spec	2.6mm .102"	15mm 5/8"	85mm 3 3/8"	10

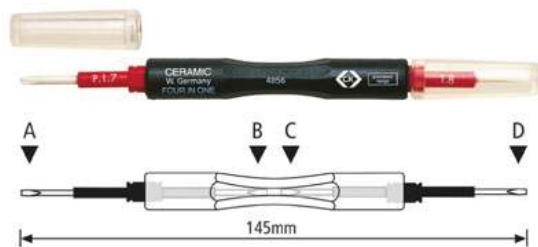

4856 4 in 1 Trimmer Ceramic

4 ceramic blades in 1 tool. 2 reversible inserts each with 2 ceramic blades. Transparent protection caps. Antistatic handle. With protection cap fitted, the blade inserts can be used as mini-alignment tools.

Item Number		
T4856	A: 0.9mm 0.35", B: PH 0 spec, C: 1.8mm 0.71" D: PH 0	10
T4856A	A: 0.9mm 0.35", B: PH 0 spec, C: 1.8mm 0.71" D: 2.6mm .102"	10

PLASTIC TRIMMERS

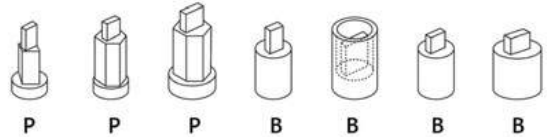

4844 Trimming Set Plastic - 7 Piece

P = Plastic B = Brass

Item Number					
T4844	-	-	-	-	1
-	1.2mm 0.047"	0.5mm 0.020"	65mm 2 1/2"	85mm 3 3/8"	-
-	1.5mm 0.047"	0.5mm 0.020"	65mm 2 1/2"	85mm 3 3/8"	-
-	2.4mm 0.094"	0.7mm 0.028"	65mm 2 1/2"	85mm 3 3/8"	-
-	1.0mm 0.039"	0.5mm 0.020"	65mm 2 1/2"	85mm 3 3/8"	-
-	2.0mm 0.079"	0.5mm 0.020"	65mm 2 1/2"	85mm 3 3/8"	-
-	1.5mm 0.059"	0.7mm 0.028"	65mm 2 1/2"	85mm 3 3/8"	-
-	2.5mm 0.098"	0.7mm 0.028"	65mm 2 1/2"	85mm 3 3/8"	-



4857 Trimming Set Plastic - 10 Piece

Set of economy single ended trimming tools with 10 different heads for the delicate trimming of electronic equipment. Manufactured from moulded/thermoplastic material. Display packed.

Item Number			
T4857	-	-	3
-	0.7 x 1.0mm	1.4mm Square	-
-	0.5 x 1.3mm	1.8mm Hex	-
-	0.8 x 2.3mm	2.5mm Hex	-
-	0.7 x 2.0mm	4.0mm Dia	-
-	0.7 x 2.4mm	5.0mm Dia	-
-	1.3mm	3.0mm Dia	-
-	0.7 x 1.0mm	3.0mm Dia	-
-	0.8 x 1.3mm	3.0mm Dia	-
-	0.8 x 1.8mm	3.0mm Dia	-
-	0.7 x 2.4mm	4.0mm Dia	-

WIRE STRIPPERS



3759 Wire Stripper

Adjustable to 6 sizes.

Item Number	Ø	
330012	0.25, 0.30, 0.40, 0.60, 0.80mm	1



3755 Wire Stripper

For fibre optic wire.

Item Number	Ø	
T3755 060	0.60mm	1



3756 Wire Stripper

For PVC, teflon and similar.

Item Number	Ø	
T3756 20	0.20mm	1
T3756 30	0.30mm	1
T3756 40	0.40mm	1
T3756 50	0.50mm	1
T3756 80	0.80mm	1



MIRRORS



5911 Inspection Mirror

Fixed head. Stainless steel handle.

Item Number	↔	∅	📦
T5911 20	164mm	20mm	6



5913 Telescopic Inspection Mirror - Long

Telescopic shaft with swivel head and pocket clip.

Item Number	↔	∅	📦
T5913 32	180 - 520mm	32mm	6



5912 Telescopic Inspection Mirror

Telescopic shaft with swivel head and pocket clip.

Item Number	↔	∅	📦
T5912 38	125 - 685mm	38mm	6
T5912 55	125 - 560mm	55mm	6



5914 Telescopic Inspection Mirror - Extra Long

Telescopic shaft with swivel head.

Item Number	↔	∅	📦
T5914 55	250 - 780mm	55mm	6

SOLDERING



950 Soldering Iron

High quality, heavy duty construction for professional use. VDE and GS certified long life tips - suitable for use with lead free solder. Replacement tip sets for C.K soldering irons contain one pointed and one chisel end.

Item Number			
495009	soldering iron 25W	3-pin plug	1
495010	soldering iron 40W	3-pin plug	1
495011	soldering iron 25W	2-pin plug	1
495012	soldering iron 40W	2-pin plug	1
495013	-	Spare tip set for 25W	1
495014	-	Spare tip set for 40W	1



6103A ESD Desoldering Tool

High capacity pump with 14.5cm³ volume. Body made from antistatic high quality glass fibre reinforced nylon. Heat resistant & conductive carbon fibre tip. Suction pressure can be increased or decreased by turning the spring around.

Item Number			
T6103A	210mm 8 1/4"	Desoldering tool	6
T6104A	-	Spare nozzle	6

OTHER



2371 ESD PLCC Extractor

For PLCC-components (20-124 pins). Fully ESD compliant for safe use on sensitive electronic components. Hardened stainless steel hooks. Self opening for repetitive action. Non overlapping handles.

IEC 61340 5.1 & 5.2

Item Number		
T2371	100mm 4"	6



1123 ESD Ball Pen

Item Number	
Z1123	1



1355 Magnetic Pickup/Pen

Item Number	
T1355	12

HAND TORCHES

208-209

FLOODLIGHTS

209

INSPECTION LIGHTS

209

TORCHES & LAMPS



HAND TORCHES



LED Rechargeable Hand Torch Set - 300 Lumens

High Power 300 Lumen Cree XM-L T6 LED. 3 Lighting modes: high, dimmed & flash. One-handed rapid slide focus mechanism - spot (x1) to flood (x6). Beam intensifying plano-convex optical lens. Robust high grade aluminium body. Water & dirt resistant. Battery life: high - 3.5hrs, dimmed - 8hrs.

IPX4

Item Number		
T9530R	131 x 34mm	6



LED Hand Torch - 120 Lumens

High Power 120 Lumen Cree XR-E Q5 LED. 3 Lighting modes: high, dimmed, flash. One-handed rapid slide focus mechanism - spot (x1) to flood (x10). Beam intensifying plano-convex optical lens. Robust high grade aluminium body. Water & dirt resistant. Battery life: high - 6hrs, dimmed - 16hrs.

IPX4

Item Number		
T9510	107 x 30mm	6



LED Hand Torch - 150 Lumens

High Power 150 Lumen Cree XR-E Q5 LED. 3 Lighting modes: high, dimmed, flash. One-handed rapid slide focus mechanism - spot (x1) to flood (x30). Beam intensifying plano-convex optical lens. Robust high grade aluminium body. Water & dirt resistant. Battery life: high - 5hrs, dimmed - 14hrs.

IPX4

Item Number		
T9520	133 x 40mm	6

LED HAND TORCH 150 LUMENS



The versatile T9520 hand torch has a remarkable 250m spot beam range and extremely broad x30 flood beam.



- 1 High Power 150 Lumen Cree XR-E Q5 LED
- 2 3 Lighting modes: high, dimmed, flash
- 3 One-handed rapid slide focus mechanism - spot (x1) to flood (x30)
- 4 Beam intensifying plano-convex optical lens
- 5 Robust high grade aluminium body
- 6 Water & dirt resistant, tested to IPX4
- 7 Battery life: high - 5hrs, dimmed - 14hrs





LED Hand Torch - 100 Lumens

High Power 100 Lumen Cree XP-E R3 LED. 3 Lighting modes: high, dimmed, flash. One-handed rapid slide focus mechanism - spot (x1) to flood (x6). Beam intensifying plano-convex optical lens. Robust high grade aluminium body. Water & dirt resistant. Battery life: high - 3hrs, dimmed - 7hrs.

IPX4

Item Number		
T9505	98 x 26mm	6

INSPECTION LIGHTS



8 LED Pocket Inspection Light

8 Super bright LEDs. Wide flood beam. 180° rotating magnetic pocket clip. Water & dirt resistant. Battery life: 8hrs.

IPX4

Item Number		
T9410	160 x 26mm	6

FLOODLIGHTS



10W Rechargeable LED Flood Light - 600 Lumens

High Performance 600 Lumen Epistar COB LED. Power: 10W. Wide 120° flood beam. Magnetic base. Vertical and horizontal rotation. Water & dirt resistant. Battery life: 3hrs.

IP65

Item Number		
T9710R	147 x 168 x 240mm	1



Inspection Lamps

Heavy duty steel cage & glass for damage protection. Rubber grip for safe handling. Suspension hook for convenience. 5m cable for long reach access. Max 60W 240v screw-in bulb (not included).

CE

Item Number		
T5901	UK 3 pin plug	1
T5901A	Euro 2 pin plug	1



Inspection Lights

Sealed 240v 8W fluorescent lamp with suspension hook for convenience. 5m cable for long reach access.

CE

Item Number		
T5902	UK 3 pin plug	2
T5902A	Euro 2 pin plug	2

Head Office:

United Kingdom
Carl Kammerling International Ltd.
Pwllheli, LL53 5LH

Tel: +44 (0)1758 701070
Fax: +44 (0)1758 704777
email: sales@cki.uk.com

UK Customer Services:

Tel: +44 (0)1758 704704
Fax: +44 (0)1758 704705
email: sales@cki.uk.com

Republic of Ireland

Tel: 1-800818 660
Fax: 1-800818 659
email: dublin-sales@cki.uk.com

www.carlkammerling.com

Carl Kammerling International's
Distribution Partners:

Germany and Rest Of World
Carl Kämmerling GmbH & Co. KG
Bendahler Str. 110,
42285 Wuppertal

Tel: +49 (0) 202.89030
Fax: +49 (0) 202.890322
email: info@cki.de.com

France

Tel: +33 (0) 810 000044
Fax: +33 (0) 810 000357
email: info@cki.de.com

Independents of America

15 York Street
Building 9, Suite 102
Biddeford, ME 04005

Tel: +1 (207) 286 8400
Fax: +1 (207) 286 8500
email: icronin@independentsofamerica.com

Carl Kammerling International Ltd. reserves the right to alter products and / or specifications without prior notice. Prices are correct at time of printing E. & O.E. All trademarks are acknowledged. All photographs are for guidance only and do not necessarily represent the products illustrated.

©2017. Published by Carl Kammerling International Ltd. No part of this publication may be produced without prior permission from Carl Kammerling International Ltd.

M4000ENG 10k / 03-17

X-ON Electronics

Largest Supplier of Electrical and Electronic Components

Click to view similar products for [Screwdrivers, Nut Drivers & Socket Drivers](#) category:

Click to view products by [CK Tools](#) manufacturer:

Other Similar products are found below :

[272012M](#) [27850](#) [CE-16-03400-00-HNDLE-TORQ](#) [323451-000](#) [HMM-HH](#) [WUVT-1-120AC-P](#) [00-8987-YWPP](#) [32024](#) [XW4Z-00B](#)
[49-22-4073](#) [96025](#) [96030](#) [96560](#) [96430](#) [31830](#) [92270](#) [96012](#) [96436](#) [96536](#) [92064](#) [72820](#) [96520](#) [92040](#) [96416](#) [96570](#) [72823](#) [96525](#) [96720](#)
[31832](#) [92020](#) [96523](#) [96510](#) [96427](#) [92073](#) [92052](#) [72905](#) [72741](#) [72663](#) [32061](#) [30751](#) [130203/TA](#) [KLEIN TOOLS SCREWDRIVER 4-IN-1](#)
[612020B](#) [35-045](#) [6951](#) [83](#) [9058](#) [9977](#) [EMF](#) [PTE6](#)