

Industrial Audible Signal 106 dB (A) Series YA40



- > Max sound output 106 db (A) / 1 m
- > IP65 rated as standard
- > 32 selectable tones meeting international regulations
- > Flame retardant ABS enclosure
- > Stainless steel fixings
- > 2 stage alarm
- > Independently selectable second stage
- > Low current consumption
- > Robust, reliable and simple to install









14569E00

E5

Yodalarm range
Compact multi-purpose audible signalling device designed for use in industrial applications.

Approvals

Certificates	
	UL 464
	C22.2 No. 205-M1983
 0086-CPR-96705	BS EN 54-3 : 2001 incorporates amendment A 1 : 2002 + A 2 : 2006
 KM 91259	BS EN 54-3 : 2001 incorporates amendment A 1 : 2002 + A 2 : 2006
	EN54-3 : 2001 + A1 : 2002 + A2 : 2006 VdS 2504 (12/96), VdS 2203 (03/01), VdS 2344 (12/05), Cert No. G28702
	Marine Equipment Directive MED Module B BSI/MED/A.1/3.53/590299, Module D BSI/MED/PC/590302

Industrial Audible Signal 106 dB (A)

Series YA40



Selection Table

Version	Enclosure colour	Rated operational voltage	Order number	Art. no.	Weight kg
YA40 Sounder, BS EN 54-3 + MED, standard devices	red normal (RN)	24 V DC	YA40/D/RN/WR	204330	0.250
		115 V AC	YA40/L/RN/WR	204354	0.350
		230 V AC	YA40/N/RN/WR	204364	0.350
YA40 Sounder, UL certification	red normal (RN)	24 V DC	YA40/D/RN/UL	204869	0.250
		115 V AC	YA40/L/RN/UL	211983	0.350
		230 V AC	YA40/N/RN/UL	211984	0.350
YA40 Sounder, VDS certification	red normal (RN)	24 V DC	YA40/D/RN/WR/VDS	211985	0.250
YA40 Sounder, general purpose	red normal (RN)	24 V AC	YA40/I/RN/WR	245154	0.350

Note Other voltages and variants are available. Please contact your local sales office for more details

Technical Data

Electrical data

Rated operational voltage	24 or 48 V DC 115 or 230 V AC	
Current consumption	24 V DC	37 mA
	48 V DC	30 mA
	115 V AC	27 mA
	230 V AC	21 mA
	24 V AC	120 mA
	at tone 1	
Operational parameters	+ or - 10% of nominal	
Line monitoring	3 wire, 2 stage or 2 wire, single stage: monitor via reverse polarity 2 wire, 2 stage i.e. bi-polar inputs: monitor via threshold (applied voltage < 1 V)	

Acoustic data

Volume	max. 106 dB (A)
Volume control	18 dB (A) adjustment
Sound stages	2, independently selectable tones
Sound selection	via DIL switch

Ambient conditions

Operating temperature range	Standard variants:	-25 ... +55 °C
	VDS certified variants:	-25 ... +40 °C
	UL certified variants:	-35 ... +66 °C
	24 V AC variants:	-25 ... +55 °C
Storage temperature	-40 ... +70 °C	
Max. relative humidity	93% ± 3 at 40 °C	

Mechanical data

Material	
Enclosure	flame retardant ABS
Assembly parts	stainless steel fixings
Labels	polyester foil, adhesive
Degree of protection	IP65 (IEC60529)

Mounting / Installation

Assembly	Should be mounted to a reasonably flat wall or bulkhead of suitable material using the internal fixing holes. The recommended fixing screws are dia. 4.5 mm max. x 20 mm long. To maintain the integrity of the weather seal, the cable entry must be fitted using a suitable sealed gland.
Connection	V DC variants separate input and output 2,5mm ² terminals V AC variants 2,5mm ² terminals

Industrial Audible Signal 106 dB (A) Series YA40



Dimensional Drawings (All Dimensions in mm [inches]) - Subject to Alterations

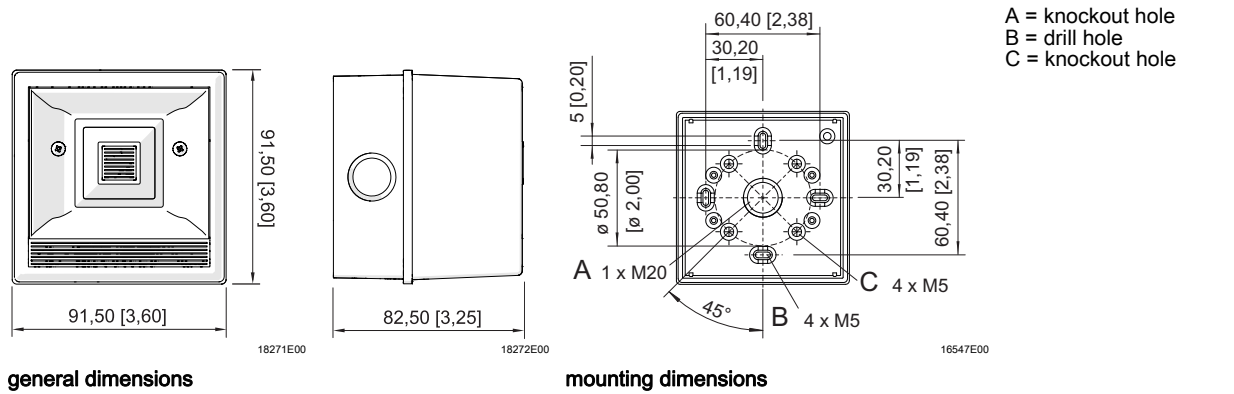

We reserve the right to make alterations to the technical data, dimensions, weights, designs and products available without notice. The illustrations cannot be considered binding.

X-ON Electronics

Largest Supplier of Electrical and Electronic Components

Click to view similar products for Clifford & Snell manufacturer:

Other Similar products are found below :

[204330](#) [204434](#) [204436](#) [204540](#) [204570](#) [204646](#) [204678](#) [204717](#) [204720](#) [204735](#) [204738](#) [YA50/N/RF/WR](#) [207067](#) [204994](#) [204364](#)
[204407](#) [204507](#) [204835](#) [204697](#) [YL40/D50/R/RN/WR](#) [FL40/D50/R/RN](#) [YA50/D/RF/WR](#) [205101](#) [204955](#) [205026](#) [205047](#) [204881](#) [204588](#)
[YL40/N50/A/RN/WR](#) [204382](#) [YL40/N50/R/RN/WR](#) [204815](#) [FL60/C/D50/A/EU](#) [FL40/D50/A/RN](#) [YL60/C/D50/R/EU](#) [YL40/D50/A/RN/WR](#)
[YL50/N50/R/RF/WR](#) [YA30/D/RF/WR](#) [YA30/N/RF/WR](#) [YL50/N50/A/RF/WR](#) [YL50/D50/A/RF/WR](#) [YL50/L50/R/RF/WR](#)
[YL50/D50/R/RF/WR](#) [YA40/D/RN/WR](#)