

# Industrial Audible Signal 106 dB (A) Series YA40



- > Max sound output 106 db (A) / 1 m
- > IP65 rated as standard
- > 32 selectable tones meeting international regulations
- > Flame retardant ABS enclosure
- > Stainless steel fixings
- > 2 stage alarm
- > Independently selectable second stage
- > Low current consumption
- > Robust, reliable and simple to install









14569E00

E5

**Yodalarm range**  
Compact multi-purpose audible signalling device designed for use in industrial applications.

### Approvals

Certificates	
	UL 464
	C22.2 No. 205-M1983
 0086-CPR-96705	BS EN 54-3 : 2001 incorporates amendment A 1 : 2002 + A 2 : 2006
 KM 91259	BS EN 54-3 : 2001 incorporates amendment A 1 : 2002 + A 2 : 2006
	EN54-3 : 2001 + A1 : 2002 + A2 : 2006 VdS 2504 (12/96), VdS 2203 (03/01), VdS 2344 (12/05), Cert No. G28702
	Marine Equipment Directive MED Module B BSI/MED/A.1/3.53/590299, Module D BSI/MED/PC/590302

# Industrial Audible Signal 106 dB (A)

## Series YA40



### Selection Table

Version	Enclosure colour	Rated operational voltage	Order number	Art. no.	Weight kg
YA40 Sounder, BS EN 54-3 + MED, standard devices	red normal (RN)	24 V DC	<b>YA40/D/RN/WR</b>	<b>204330</b>	0.250
		115 V AC	<b>YA40/L/RN/WR</b>	<b>204354</b>	0.350
		230 V AC	<b>YA40/N/RN/WR</b>	<b>204364</b>	0.350
YA40 Sounder, UL certification	red normal (RN)	24 V DC	<b>YA40/D/RN/UL</b>	<b>204869</b>	0.250
		115 V AC	<b>YA40/L/RN/UL</b>	<b>211983</b>	0.350
		230 V AC	<b>YA40/N/RN/UL</b>	<b>211984</b>	0.350
YA40 Sounder, VDS certification	red normal (RN)	24 V DC	<b>YA40/D/RN/WR/VDS</b>	<b>211985</b>	0.250
YA40 Sounder, general purpose	red normal (RN)	24 V AC	<b>YA40/I/RN/WR</b>	<b>245154</b>	0.350

Note Other voltages and variants are available. Please contact your local sales office for more details

### Technical Data

#### Electrical data

Rated operational voltage	24 or 48 V DC 115 or 230 V AC	
Current consumption	24 V DC	37 mA
	48 V DC	30 mA
	115 V AC	27 mA
	230 V AC	21 mA
	24 V AC	120 mA
	at tone 1	
Operational parameters	+ or - 10% of nominal	
Line monitoring	3 wire, 2 stage or 2 wire, single stage: monitor via reverse polarity 2 wire, 2 stage i.e. bi-polar inputs: monitor via threshold (applied voltage < 1 V)	

#### Acoustic data

Volume	max. 106 dB (A)
Volume control	18 dB (A) adjustment
Sound stages	2, independently selectable tones
Sound selection	via DIL switch

#### Ambient conditions

Operating temperature range	Standard variants:	-25 ... +55 °C
	VDS certified variants:	-25 ... +40 °C
	UL certified variants:	-35 ... +66 °C
	24 V AC variants:	-25 ... +55 °C
Storage temperature	-40 ... +70 °C	
Max. relative humidity	93% ± 3 at 40 °C	

#### Mechanical data

Material	
Enclosure	flame retardant ABS
Assembly parts	stainless steel fixings
Labels	polyester foil, adhesive
Degree of protection	IP65 (IEC60529)

#### Mounting / Installation

Assembly	Should be mounted to a reasonably flat wall or bulkhead of suitable material using the internal fixing holes. The recommended fixing screws are dia. 4.5 mm max. x 20 mm long. To maintain the integrity of the weather seal, the cable entry must be fitted using a suitable sealed gland.
Connection	V DC variants separate input and output 2,5mm <sup>2</sup> terminals V AC variants 2,5mm <sup>2</sup> terminals

# Industrial Audible Signal 106 dB (A) Series YA40



## Dimensional Drawings (All Dimensions in mm [inches]) - Subject to Alterations

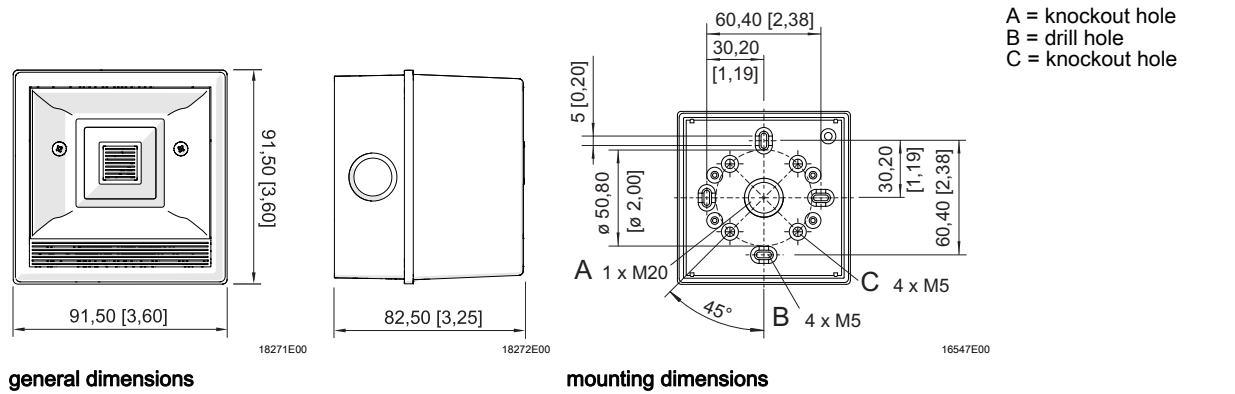

We reserve the right to make alterations to the technical data, dimensions, weights, designs and products available without notice. The illustrations cannot be considered binding.

## **X-ON Electronics**

Largest Supplier of Electrical and Electronic Components

*Click to view similar products for [Clifford & Snell](#) manufacturer:*

Other Similar products are found below :

[204330](#) [204434](#) [204436](#) [204540](#) [204570](#) [204646](#) [204678](#) [204717](#) [204720](#) [204735](#) [204738](#) [YA50/N/RF/WR](#) [207067](#) [204994](#) [204364](#)  
[204407](#) [204507](#) [204835](#) [204697](#) [YL40/D50/R/RN/WR](#) [FL40/D50/R/RN](#) [YA50/D/RF/WR](#) [205101](#) [204955](#) [205026](#) [205047](#) [204881](#) [204588](#)  
[YL40/N50/A/RN/WR](#) [204382](#) [YL40/N50/R/RN/WR](#) [204815](#) [FL60/C/D50/A/EU](#) [YL60/C/D50/R/EU](#) [FL40/D50/A/RN](#) [YL40/D50/A/RN/WR](#)  
[YL50/N50/R/RF/WR](#) [YA30/D/RF/WR](#) [YA30/N/RF/WR](#) [YL50/N50/A/RF/WR](#) [YL50/D50/A/RF/WR](#) [YL50/L50/R/RF/WR](#)  
[YL50/D50/R/RF/WR](#) [YA40/D/RN/WR](#)