

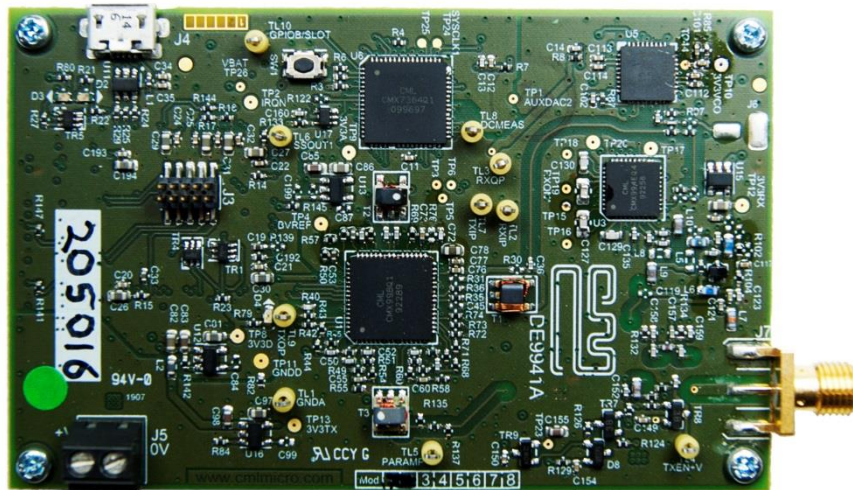

**Features**

- Demonstration of SDR wireless data modem supporting multiple bit rates and modulation schemes
- Direct Conversion Receiver (CMX994E) and Cartesian Feedback Loop Transmitter (CMX998)
- 1W Transmitter Operation
- Designed to meet EN 302 561 / EN 300 113
- Provides a demonstration platform for the CMX7364 Multi-mode High Performance Wireless Data Modem
- On-board PLL and VCO for 350 to 400 MHz Operation
- On-board STM32 ARM microcontroller and script handler + USB interface
- Small size – 87mm x 55mm



**1 Brief Description**

The DE9941A is a small demonstration platform for the CMX994E Direct Conversion Receiver, the CMX998 Cartesian Loop Transmitter and the CMX7364 Multi-mode High Performance Wireless Data Modem. The small form factor of the demonstration/evaluation platform is possible due to the compact nature of the CML IC solutions. The DE9941A can be used to demonstrate Tx and Rx performance with multi-level QAM, FSK and GMSK type modulation. Together with the on-board ARM host controller, a full transceiver can be demonstrated using a Function Image™ and control scripts.

The DE9941A provides a Fractional-N PLL and VCO to provide local oscillator signals for the CMX994E and CMX998. The on-board ARM microcontroller, together with the control scripts, gives the user the ability to program the RF synthesiser to the correct operating frequencies. The design also includes a 1W power amplifier, harmonic filter and Tx/Rx switch. The RF performance is designed to be compliant with EN 302 561 / EN 300 113 and all the circuits are provided with power-down capability to allow standby functionality.

The design is aimed to be low cost, with a minimum number of component types/values.

## CONTENTS

<u>Section</u>		<u>Page</u>
<b>1</b>	<b>Brief Description .....</b>	<b>1</b>
<b>2</b>	<b>Block Diagram.....</b>	<b>4</b>
<b>3</b>	<b>Preliminary Information .....</b>	<b>5</b>
3.1	Laboratory Equipment.....	5
3.1.1	Power Supply.....	5
3.2	Handling Precautions .....	5
3.2.2	Contents - Unpacking.....	5
3.3	Approvals.....	5
<b>4</b>	<b>Quick Start.....</b>	<b>6</b>
4.1	Setting-Up.....	6
4.1.1	ES9941A Software and Driver Installation .....	7
4.2	Configuration.....	8
4.2.1	Tx Configuration.....	8
4.2.2	Rx Configuration.....	8
4.3	Operation .....	8
<b>5</b>	<b>Signal Lists.....</b>	<b>9</b>
<b>6</b>	<b>Circuit Schematics and Board Layouts .....</b>	<b>10</b>
<b>7</b>	<b>Detailed Description .....</b>	<b>11</b>
7.1	Hardware Description .....	11
7.1.1	Harmonic Filter.....	11
7.1.2	Tx/Rx Switch .....	11
7.1.3	Coupler.....	11
7.1.4	Power Amplifier.....	11
7.1.5	Transmitter.....	11
7.1.6	Receiver.....	12
7.1.7	Local Oscillator.....	12
7.1.8	Reference Oscillator .....	12
7.1.9	Power Supply.....	12
7.1.10	Inductors.....	12
7.1.11	Adjustments and Controls External/Internal LO.....	12
7.2	Software Description.....	12
7.3	Application Information .....	12
7.3.1	GUI Description .....	12
7.3.2	Function Image Load .....	13
7.3.3	Scripts Handler Tab .....	13
7.3.4	Typical Receiver Results with CMX7364 FI-4 .....	20
7.3.5	Typical Transmit Performance with CMX7364 FI-4.....	25
7.4	Troubleshooting .....	32
7.4.1	Receiver Operation.....	32
7.4.2	Transmitter Operation .....	32
<b>8</b>	<b>Performance Specification .....</b>	<b>33</b>
8.1	Electrical Performance .....	33
8.1.1	Absolute Maximum Ratings .....	33
8.1.2	Operating Limits .....	33
8.1.3	Operating Characteristics.....	34

<u>Table</u>	<u>Page</u>
Table 1 Connector List.....	9
Table 2 Test Points.....	9
Table 3 DE9941A Channel Table.....	14
Table 4 Sensitivity levels (mean power) for different gross (on-air) bit rates in a 25kHz channel.....	21
Table 5 4-QAM Rx Adjacent Channel Rejection with a FM Interferer at +/-25kHz Offset.....	22
Table 6 16-QAM Rx Adjacent Channel Rejection with FM Interferer at +/-25kHz offset.....	23
Table 7 64-QAM Rx Adjacent Channel Rejection with a FM Interferer at +/-25kHz offset.....	23
Table 8 Co-channel Performance for different gross (on-air) bit rates.....	23
Table 9 Rx Intermodulation Performance for 4-QAM in Enhanced IP3 mode.....	24
Table 10 4-QAM Rx Spurious Response and Blocking Performance.....	25
Table 11 Tx Performance at 366.5MHz with different QAM and Channel Filter Types.....	25
Table 12 Summary of 16-QAM Tx Output Power and ACP Performance.....	26
Table 13 Receiver - Possible Errors.....	32
Table 14 Transmitter - Possible Errors.....	32

<u>Figure</u>	<u>Page</u>
Figure 1 Block Diagram.....	4
Figure 2 Typical Evaluation Connections for DE9941A.....	7
Figure 3 PCB Layout: top.....	10
Figure 4 PCB Layout: bottom.....	10
Figure 5 Function Image Load.....	13
Figure 6 Setup Script Channel No Selection.....	15
Figure 7 Setup Script User Prompt to Ensure Rx Input is OFF to Allow Rx DC Calibration.....	15
Figure 8 Setup Script User Prompt to Check Rx Performance.....	16
Figure 9 Setup Script User Prompt to Check Tx Null Condition.....	16
Figure 10 Setup Script Log Screen after Script has completed.....	17
Figure 11 Rx Script User Prompt to Enable AGC.....	18
Figure 12 Tx Script User Prompt to Select Modulation Type to Send (4, 16, 32 or 64).....	18
Figure 13 Rx Script Log Screen Following Successful Reception.....	19
Figure 14 Tx Script Log Screen Following Successful Transmission.....	19
Figure 15 Typical ber_results.txt file Output From the Rx.....	20
Figure 16 Rx Sensitivity with 4-QAM, 16-QAM and 64-QAM at 18 ksymbols/s.....	21
Figure 17 Rx Sensitivity at Different Frequencies with 4-QAM, 18 ksymbols/s.....	22
Figure 18 4-QAM, 16-QAM and 64-QAM Co-Channel Performance.....	24
Figure 19 16-QAM, 18 ks/s, ACP Performance at 350.05MHz.....	26
Figure 20 16-QAM, 18 ks/s, ACP Performance at 366.5MHz.....	26
Figure 21 16-QAM, 18 ks/s, ACP Performance at 399.55MHz.....	27
Figure 22 16-QAM, 9.6 ks/s, ACP Performance at 366.5MHz.....	27
Figure 23 16-QAM, 40 ks/s, ACP Performance at 366.5MHz.....	27
Figure 24 16-QAM, 18 ks/s, Constellation and EVM at 366.5MHz.....	28
Figure 25 16-QAM, 9.6 ks/s, Constellation and EVM at 366.5MHz.....	28
Figure 26 16-QAM, 40 ks/s, Constellation and EVM at 366.5MHz.....	28
Figure 27 Wideband Plots of Tx at 350.05MHz.....	29
Figure 28 Wideband Plots of Tx at 366.5MHz.....	29
Figure 29 Wideband Plots of Tx at 399.55MHz.....	29
Figure 30 Ramp-up and Ramp-down Profile (QAM).....	30
Figure 31 Tx Spectral Purity in Transient Mode, 200kHz Span (QAM).....	30
Figure 32 Tx Spectral Purity in Transient Mode, 1MHz Span (QAM).....	30
Figure 33 Tx Spectral Purity in Transient Mode, 10MHz Span (QAM).....	31

It is always recommended that you check for the latest product datasheet version from the Products page of the CML website: [www.cmlmicro.com].

### History

Version	Changes	Date
1	First Issue	April 2020

## 2 Block Diagram

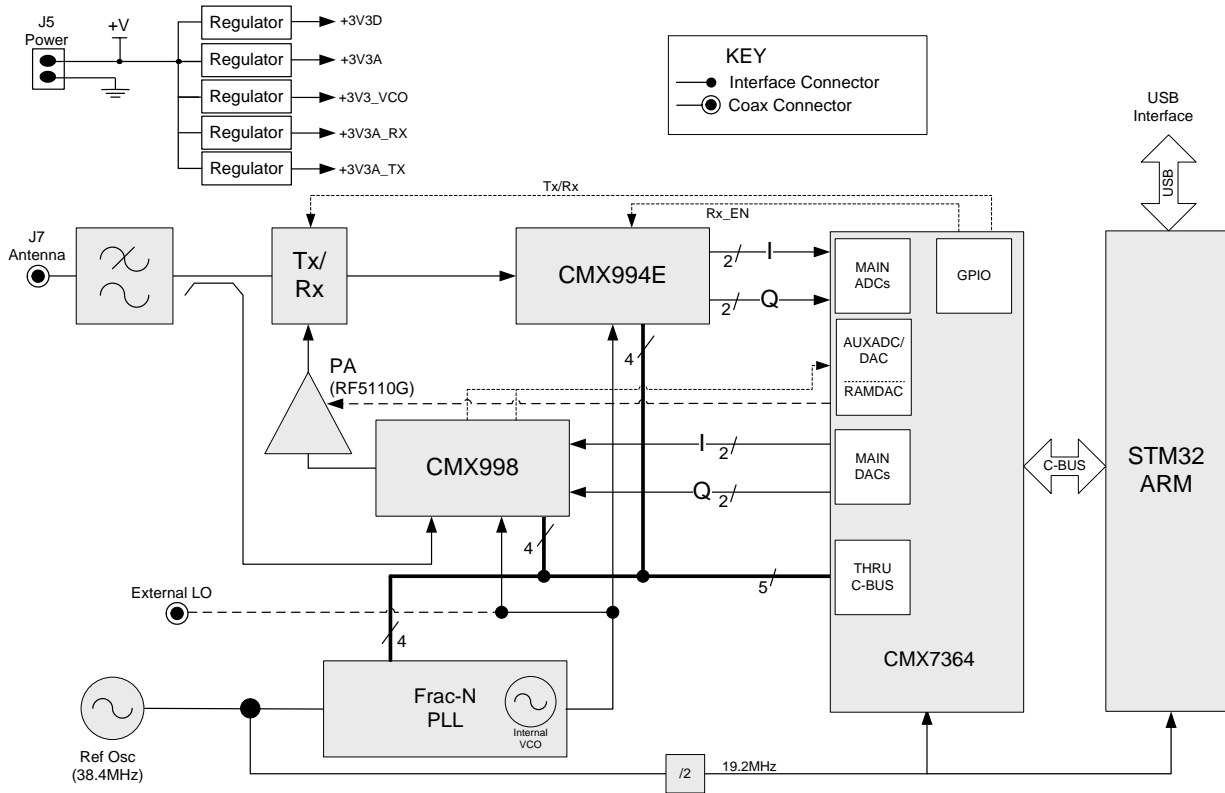

Figure 1 Block Diagram

### 3 Preliminary Information

The DE9941A provides a RF platform for demonstration and evaluation of the CMX7364 Multi-mode High Performance Wireless Data Modem, with the use of the CMX994E Direct Conversion Receiver and the CMX998 Cartesian Feedback Loop Transmitter. A 1W power amplifier has been included plus Fractional-N PLL with integral VCO for stand-alone operation.

The DE9941A is designed to be used with the ES9941A software package running on a PC which provides controller functionality via the USB interface. This software allows scripts to be used to control the CMX7364. All RF circuits are controlled via the CMX7364 C-BUS interface. Various scripts are available for use with the DE9941A (see section 7.3.1). Alternatively users may implement their own host controller solution on the ARM (STM32) microcontroller.

#### 3.1 Laboratory Equipment

The following laboratory equipment is needed to use this demonstration/evaluation kit:

- Power Supply
- Spectrum Analyser
- RF Signal Generator
- Oscilloscope
- Personal Computer + USB interface

For more detailed design or investigation work, additional RF test equipment may be required.

##### 3.1.1 Power Supply

The supply input voltage to the PCB is nominally 4.5V (3.6V to 4.8V acceptable). On-board regulators are provided to generate all voltage rails used on the PCB (3.3V). The 4.5V supply should be rated at 2A.

**NOTE:** Care should be exercised with the supplies as they are not protected for reverse polarity. The 4.5V supply directly feeds the power amplifier and it should not exceed 5.0V for nominal operating limits.

#### 3.2 Handling Precautions

Like most evaluation kits, this product is designed for use in office and laboratory environments. The following practices will help ensure its proper operation.

##### 3.2.1 SSD Devices



**This product uses low-power CMOS circuits that can be damaged by electrostatic discharge. Partially-damaged circuits can function erroneously, leading to misleading results. Observe ESD precautions at all times when handling this product.**

##### 3.2.2 Contents - Unpacking

Please ensure that you have received all of the items on the separate information sheet (EK9941A-375) and notify CML within seven working days if the delivery is incomplete.

#### 3.3 Approvals

This product is not approved to any EMC or other regulatory standard. Users are advised to observe local statutory requirements, which may apply to this product and the radio frequency signals that may emanate from it.

## 4 Quick Start

This section provides instructions for users who wish to experiment immediately with this Evaluation Kit at 350 to 400 MHz. A more complete description of the kit and its uses appears later in this document. The user should read the appropriate CMX7364, CMX994E and CMX998 Datasheets before using the DE9941A board.

This Quick Start configuration assumes that the user has installed the ES9941A Windows GUI software which provides the interface between DE9941A and a controlling PC. The script language used is the same as the PE0003. The PE0003 Script Language Reference document is available from the Design Resources area of the PE0003 product page on the CML website.

### 4.1 Setting-Up

The following procedure is recommended:

1. Connect the boards as shown in Figure 2. J7 should be connected to either an RF signal generator or spectrum analyser via a suitable 50Ω attenuator. If testing the transmitter, the RF output J7 should be connected to a suitable 50Ω load.  
**THE USE OF AN EXTERNAL 50Ω LOAD IS ESSENTIAL TO PREVENT POSSIBLE DAMAGE TO THE RF POWER AMPLIFIER STAGE.**
2. Connect the PC to the DE9941A USB interface connector J4, note that this will apply power to board via the USB interface.
3. Apply power to the DE9941A, note that connecting the USB interface will apply power sufficient for Rx operation but not Tx operation. For Tx operation a power supply capable of 2A is required.
4. Install the ES9941A software when prompted.
5. The CMX7364 fitted to the DE9941A must be loaded with the required Function Image™. This can be done using the GUI. Programming of the RF PLL IC, the CMX994E and the CMX998 is via the GUI using a suitable script, for which examples are available (see section 7.3.1).

The board is now ready for operation.

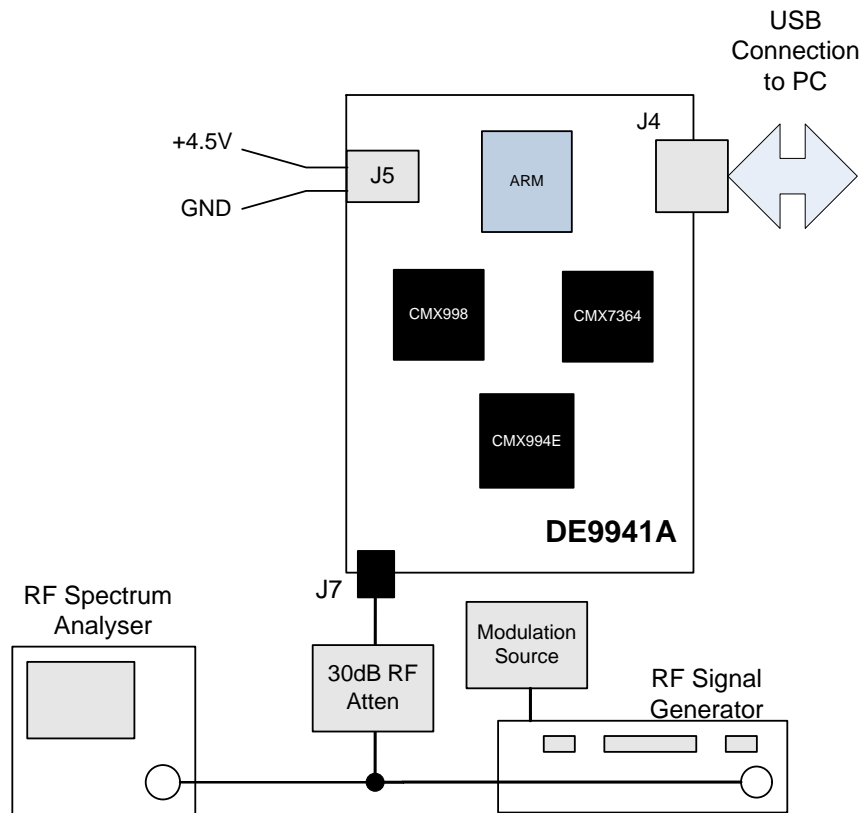

Figure 2 Typical Evaluation Connections for DE9941A

#### 4.1.1 ES9941A Software and Driver Installation

When connecting the DE9941A for the first time the Windows 10 driver for the STM microcontroller should be automatically installed. If any problems are experienced the STM32 Virtual Com Port driver can be downloaded from the STM website. The GUI is available to download from the CML website. The script language is described in the PE0003 User Manual.

## 4.2 Configuration

The CMX7364 must be loaded with a Function Image (FI) to initialise the device and determine the modulation type; FI-1.x supports GMSK/GFSK, FI-2.x supports multi-level FSK and FI-4.x supports 4/16/64-QAM. This User Manual focuses on FI-4.x because this fully utilises the Tx functionality due to QAM being a non-constant envelope modulation.

The following procedures allow the user to quickly set up the DE9941A for Rx or Tx operation.

### 4.2.1 Tx Configuration

The following steps will configure the DE9941A to transmit at 361.05MHz with a continuous 4-QAM PRBS modulated output. Set the applied signals and run the scripts (see section 7.3.1 for details on the scripts) in the order shown in the following table. Note: Ensure J7 is connected to a Spectrum analyser via a suitable 50Ω attenuator for Tx testing.

Note: Setting the CML device registers requires the use of the DE9941A host connected as above. The CML datasheets give details of the registers and commands.

Script/Command	Setting	Note
DE9941A-QAM-Setup	Script allows selection of: <ul style="list-style-type: none"> <li>Baud rate</li> <li>Rx Bandwidth</li> <li>Mod size</li> <li>Frequency</li> </ul>	At top of the script ensure: Baud rate 18 ksymbols/s, Rx_BW = 25, modulation = 4 and Channel No = 4 (Operating Frequency is 361.05MHz).
DE9941A-QAM-setup	Script automatically performs a full DC Calibration on the CMX998	User is prompted by script to check carrier null if required. If yes is selected the carrier null can be analysed. Note PA will be enabled at this point. The Tx output level should be <-25dBm, the output should be nulled unmodulated carrier.
Write \$103A to modem control register (\$6B)	Apply Tx PRBS	The Tx output will now be at full output power (circa +25dBm mean) continuously. Note: due to limited heatsinking in the compact design it is advised to avoid leaving the Tx in this state for long periods of time.

### 4.2.2 Rx Configuration

The following steps will configure the DE9941A to receive at 361.05MHz with a 1kHz tone IQ output. Set the applied signals and run the scripts (see section 7.3.1 for details on the scripts) as shown in the following table.

Note: Ensure that J7 is connected to a RF signal generator via a suitable 50Ω attenuator for Rx testing.

Setting the CML device registers requires the use of the DE9941A host connected as above. The CML datasheets give details of the registers and commands.

Signal/Script	Setting	Note
DE9941A-QAM-setup	Script allows selection of: <ul style="list-style-type: none"> <li>Baud rate</li> <li>Rx Bandwidth</li> <li>Mod size</li> <li>Frequency</li> </ul>	At top of the script ensure: Baud rate 18 ksymbols/s, Rx_BW = 25, modulation = 4 and Channel No = 4 (Operating Frequency is 361.05MHz).
ANTENNA (J7)	361.051MHz	The input level here may be user defined: for an input signal of -60dBm at J7, the typical single-ended output level would be ~410mV p-p at TL2. The output should be a 1kHz sine and cosine wave on I and Q when the configuration in this table is completed.
RXIP (TL2)	RXI output	The differential I signal can be measured at TL2 and the differential Q signal can be measured at TL3.

## 4.3 Operation

Following the configuration procedures given in sections 4.1 and 4.2 the DE9941A should be operating as a transmitter or receiver at 361.05MHz. Various evaluation tests can now be performed.



## 5 Signal Lists

Table 1 Connector List

CONNECTOR PINOUT				
Connector Ref.	Connector Pin No.	Signal Name	Signal Type	Description
J7	N/A	ANTENNA	RF	Tx Output or Rx Input
J5	2	+V	DC	4.5V Power supply input
J5	1	GNDA	DC	Power supply ground

Table 2 Test Points

TEST POINTS		
Test Point Ref.	Default Measurement	Description
TP1	-	AUXDAC2 – VCTCXO Control Voltage
TP2	-	IRQn on ARM
TP3	-	AUXADC1 – Tx Instability Detector Output
TP4	1.6V dc	CMX998 BVRef (Buffered Vref)
TP5	-	AUXADC3 – CMX998 Q Feedback Path Output
TP6	-	AUXADC4 – CMX998 I Feedback Path Output
TP7	-	AUXADC2 – CMX998 DC Meas – used for DC Calibration
TP8	3.3V dc	+3V3D - Digital Power Supply
TP9	3.3V dc	+3V3A - Analogue Power Supply
TP10	3.3V dc	+3V3_VCO - VCO and PLL Power Supply
TP11	0V	DGND - Digital Ground
TP12	3.3V dc	+3V3A_RX - Rx Analogue Power Supply
TP13	-	+3V3A_TX - Tx Analogue Power Supply
TP14	1.3 – 1.4VDC-	VCO Control Voltage
TP15	-	RXI+
TP16	-	RXI-
TP17	-	GPIOD/RXD
TP18	-	RXQ+
TP19	-	RXQ-
TP20	3.3V dc	CMX994E Vddio Power Supply Voltage
TP21	-	TXEN+V Tx/Rx PIN switch supply
TP22	-	AUXDAC1 - PARAMP PA control ramp
TP23	-	VAPC – PA control pins
TP24	-	CMX7364 – SYSCLK1
TP25	-	CMX7364 – SYSCLK2
TP26	-	VBAT – Back up voltage supply 1

Notes:

I/P	=	Input
O/P	=	Output
TP	=	Test Point

## 6 Circuit Schematics and Board Layouts

The DE9941A circuit schematic is available as separate high-resolution files, which can be downloaded from the CML website. The layout on each side of the pcb is shown in Figure 3 and Figure 4 below.

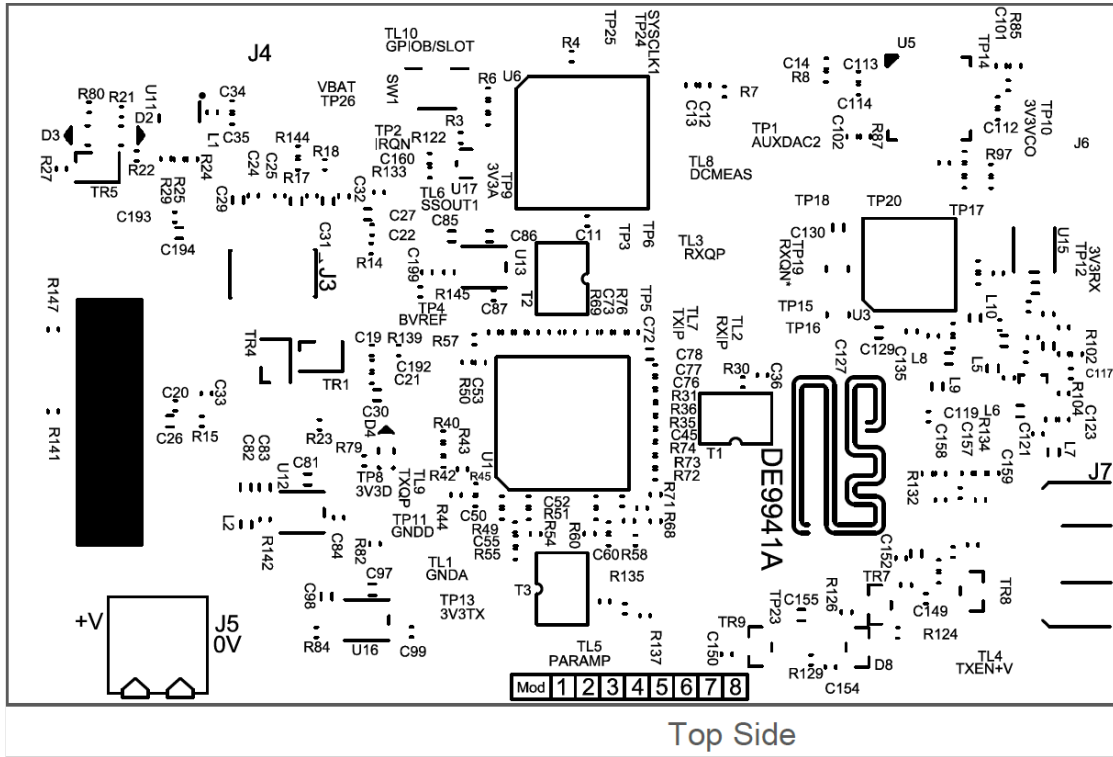

Figure 3 PCB Layout: top

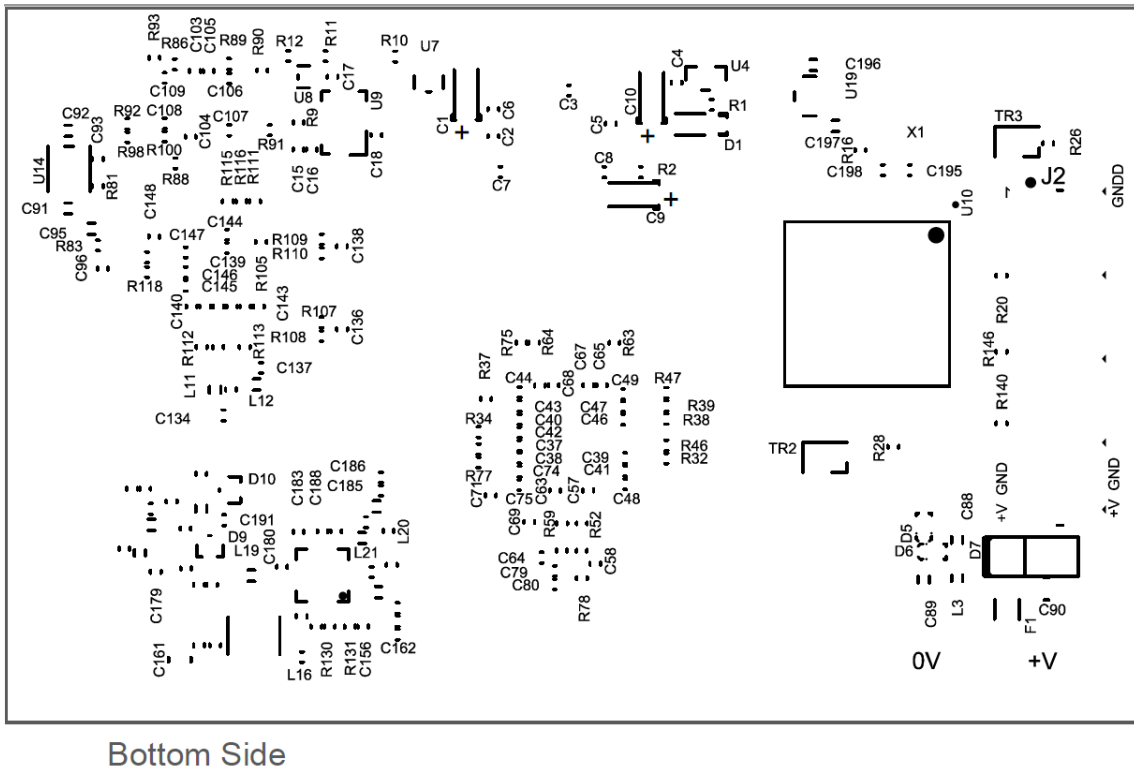

Figure 4 PCB Layout: bottom

## 7 Detailed Description

The DE9941A functionality includes:

- Nominal +4.5V Supply
- Direct Conversion Receiver
- Cartesian Feedback Loop Transmitter
- 1W Power Amplifier
- Fractional-N PLL with integrated VCO
- 38.4MHz VCTCXO
- Operation from 350 to 400 MHz
- USB Interface that allows the card to be connected to a host PC and allows control of all device functions, to support initial test and customer evaluation.
- Capability to demonstrate the performance of the CMX7364 Multi-mode High Performance Wireless Data Modem, for example 4/16/64-QAM, 2/4FSK and GMSK.

In summary, the DE9941A allows the user to experiment and investigate all aspects of the CMX7364 device using an RF platform based around the CMX994E Direct Conversion Receiver and the CMX998 Cartesian Feedback Loop Transmitter. The DE9941A is designed to allow user modification to support detailed investigation of the user's various applications. The evaluation platform also includes additional circuits that allow the user to use the, DE9941A in standalone mode for example a fractional-N PLL (U5) with integrated VCO.

### 7.1 Hardware Description

#### 7.1.1 Harmonic Filter

L17, L18 and associated components form a low-loss low pass filter with taps centred at the 2<sup>nd</sup> and 3<sup>rd</sup> Tx harmonics. This filter is common to the transmitter and receiver paths and is connected between the Tx/Rx switch and the antenna connector J7.

#### 7.1.2 Tx/Rx Switch

The Tx/Rx switch is a classic series-shunt switch using PIN diodes (D9 and D10) after a lumped quarter wave section. The diodes are activated in transmit via the GPIOC/TXD signal from the CMX7364. An additional diode is provided (at D10), in anti-parallel, to protect the LNA from extremely strong signals (e.g. a nearby transceiver). This branch of the switch then goes to the receiver input.

#### 7.1.3 Coupler

The coupler is a lumped coupler formed around one of the low pass sections of the harmonic filter (L17). The signal is coupled from this low pass section to another low pass section (L14) via very low value capacitors (C166 & C167). The coupling factor is ~ 31dB and the output of the coupler forms part of the feedback path to the CMX998 to create the Tx cartesian loop.

#### 7.1.4 Power Amplifier

The DE9941A includes a 1W Power Amplifier U2 (RF5110G) configured for 350 to 400 MHz operation and is capable of producing ~+25dBm (mean) output power with 16-QAM modulation.

The CMX7364 RAMDAC (AUXDAC1) output is connected to the PA control line via a diode and transistor (D8 and TR9) to provide sufficient current to the PA control pins.

#### 7.1.5 Transmitter

The transmitter is based on the CMX998 Cartesian Feedback Loop Transmitter (CFBL) IC plus the PA and coupler which complete the loop. The up-converter, down-converter and LO Input are matched with broadband baluns. The LO is at two times the final operating frequency (700 to 800 MHz). The CMX998 IQ differential inputs are provided straight from the CMX7364 main DAC's. The error amplifier is configured with a loop filter optimised for operation with the on-board power amplifier and for modulation bandwidths up to 50kHz.

The DCMEAS pin is connected to an AUXADC (2) on the CMX7364 to allow automatic DC calibration and the ability to control the PA from the CMX7364.

The CMX998 is controlled via the CMX7364 SPI-Thru port using chip select 1 (SSOUT1).

### 7.1.6 Receiver

The receiver uses the CMX994E Direct Conversion Receiver which is capable of supporting a range of digital radio systems of both constant envelope and linear modulation types. The CMX994E integrated LNA has been utilised with the output of the LNA matched directly to the IQ down conversion mixer. The mixer converts the received signal to IQ baseband format, where C129 and C130 combine with on-chip components to remove off-channel signals. The signal is then amplified before further filtering to remove adjacent channel signals (C127 and C128). The nominal maximum bandwidth of the adjacent channel filters is 16kHz and this is scaled by a factor of 2 or 4 in the other filter bandwidth states. A final amplifier stage completes the receiver line-up, providing differential IQ outputs directly to the CMX7364 Main ADCs.

The overall receiver gain and noise figure for the default configuration is  $\sim 63.5$ dB and  $\sim 6$ dB respectively. The Rx input third-order intercept point is  $\sim -2$  to  $-3$ dBm in normal mode and  $\sim +1$  to  $+2$  dBm in enhanced mode.

The LO input is at two times the final operating frequency.

The CMX994E is controlled via the CMX7364 SPI-Thru port using chip select 1 (SSOUT1).

### 7.1.7 Local Oscillator

The LO (Local Oscillator) for the Tx and the Rx is at two times the final operating frequency. The LMX2571 has been used to provide the LO, it integrates a Fractional N PLL, VCO, programmable dividers and output buffers. The LMX2571 also includes a partially integrated loop filter. The LMX2571 (U5) is controlled via the CMX7364 SPI Thru port and uses chip select 2 (SSOUT2).

If required an external LO source (J6 PCB pad) can be used instead of the on-board VCO.

### 7.1.8 Reference Oscillator

A 1.5ppm 38.4MHz VCTCXO (Golledge MP08120) is used as the reference for the Frac-N PLL and is divided by 2 for the CMX7364 (U6) and ARM (U10 - STM32).

### 7.1.9 Power Supply

The input to the PCB is nominally 4.5V (3.5V to 4.8V is acceptable). On-board regulators are provided to generate voltage rails used on the DE9941A.

### 7.1.10 Inductors

All inductors used in the RF sections of the design are manufactured by Coilcraft ([www.coilcraft.com](http://www.coilcraft.com)). Performance of the circuits with inductors from other manufacturers may vary.

### 7.1.11 Adjustments and Controls External/Internal LO

An external LO may be applied at J6 but R96 should be moved to position R97 and the LMX2571 powered down.

## 7.2 Software Description

Please refer to the PE0003 User Manual for detailed description of the script handler software (see [www.cmlmicro.com](http://www.cmlmicro.com) for more information). This is implemented on the on-board ARM microcontroller using the USB interface to a suitable PC running the ES9941A GUI. Section 7.3.1 gives detailed information about scripts developed for the DE9941A Evaluation kit.

## 7.3 Application Information

See section 4.1 for board setup details and section 4.2 for operating the DE9941A as a transmitter or receiver.

### 7.3.1 GUI Description

The GUI has a number of tabs as follows:

- C-BUS Control – allows single register write and read commands to the selected device (device 1 only should be used).
- C-BUS Ctrl Ext 1 and 2 – a set of register writes and reads can be configured, saved and recalled (device 1 only should be used).
- Function Image Load – user can browse to the FI location and load the FI to device 1. If the “Read Three Words” is ticked the FI version number will be displayed correctly.

- Script Handler – allows users to execute script files consisting of register write, read, and delay commands. Section 7.3.3 provides a description of some scripts provided to demonstrate the functionality of the DE9941A with FI-4.

### 7.3.2 Function Image Load

Using the Function Image Load tab the latest FI-4 firmware can be loaded. Figure 5 shows the GUI after a successful load of the FI.

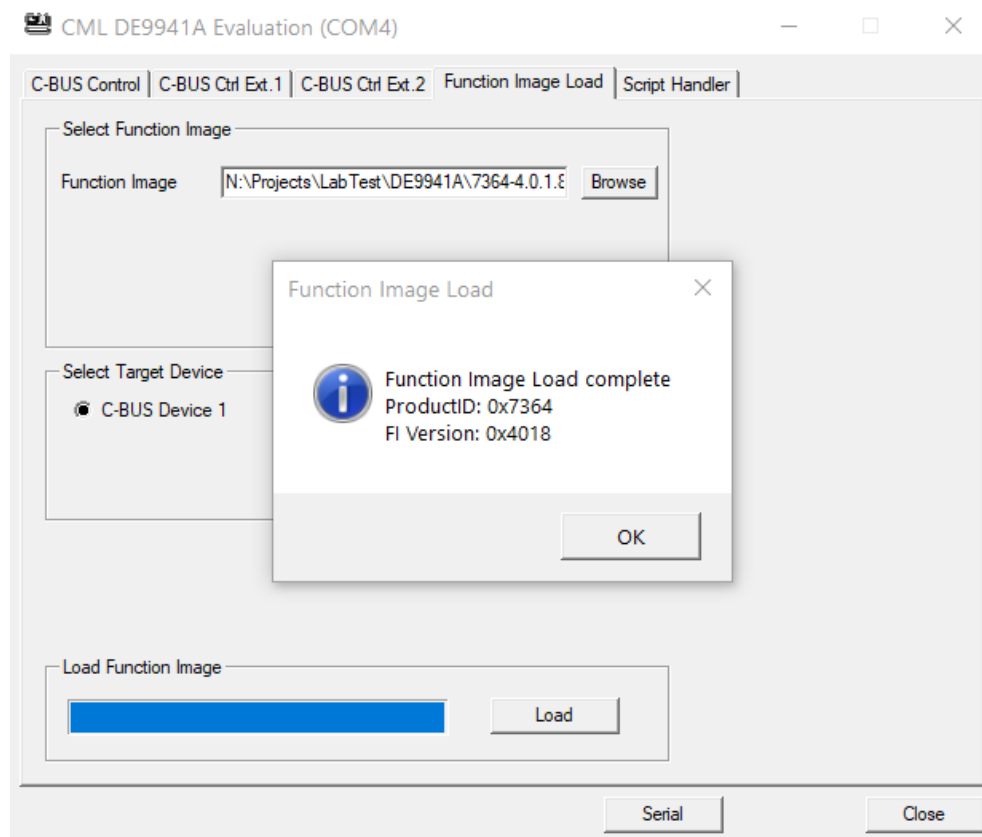

Figure 5 Function Image Load

### 7.3.3 Scripts Handler Tab

Scripts can be executed using the “Script Handler” tab - browse to the relevant scripts and then press Run.

The following scripts are available to support the DE9941A:

- DE9941A\_QAM\_Setup – Must be run first on the Tx and Rx device
- DE9941A\_QAM\_Test\_RX– BER Script to be run first on the Rx
- DE9941A\_QAM\_Test\_TX– Only used with the Tx device

The scripts assume that the user has two DE9941As, one for Tx and one for Rx, although the setup script can be used to check the static performance of the Rx and Tx if required. A brief description of the function of each script is given in the following sections.

**DE9941A\_QAM\_Setup**

At the top of this script there is a section which allows the user to adjust some variables: these are baud rate, Rx channel BW, modulation type and channel No. The baud rate can be set to 9.6 k, 18 k, and 40 k. Other baud rates can be used but the script is optimised for use with these three baud rates. The receiver ACR bandwidth can be changed using the variable Rx\_BW. Valid values are 12 for 12.5kHz system, 25 for 25kHz system and 50 for 50kHz system. The QAM modulation type can be set to 4, 16 and 64. The script includes a channel table which configures the LMX2571 over the entire operating range of 350.05MHz to 399.55MHz. The channel table is shown in Table 3.

**Table 3 DE9941A Channel Table**

Frequency (MHz)	Channel No
351.25	1
353.5	2
355.95	3
361.05	4
363.5	5
365.95	6
350.05	7
366.5	8
383.5	9
399.55	10

The script configures the CMX994E and CMX998. To ensure the best receiver performance is achieved it is necessary to train the Rx equaliser in the CMX7364; this has to be done with a good quality 4QAM input signal. The setup script has pre-trained equaliser filter values for the following three cases; 9.6 ks/s using the minimum ACR filter setting (12.5 kHz system), 18 ksymbols/s using the mid filter setting (25kHz system) and 40 ksymbols/s using the maximum filter setting (50kHz system). The trained equaliser filter will automatically be loaded depending on the Rx\_BW setting. The setup script performs a DC calibration of the CMX994E, the user is prompted to turn any input signal off while this is done so that the best result is achieved. The script log screen will tell the user what final value has been programmed in the extended DC offset register (\$17) of the CMX994E.

The setup script also sets up and executes a full DC calibration of the transmitter (CMX998). It also configures the high gain calibration condition for any subsequent DC calibrations performed on the transmitter.

The setup script also gives the user the ability to analyse the Rx performance typically described in section 4.2.2 and the Tx performance as described in section 4.2.1. See screenshots of the GUI in Figure 6 to Figure 10 which show the user prompts that occur during the execution of the setup script.

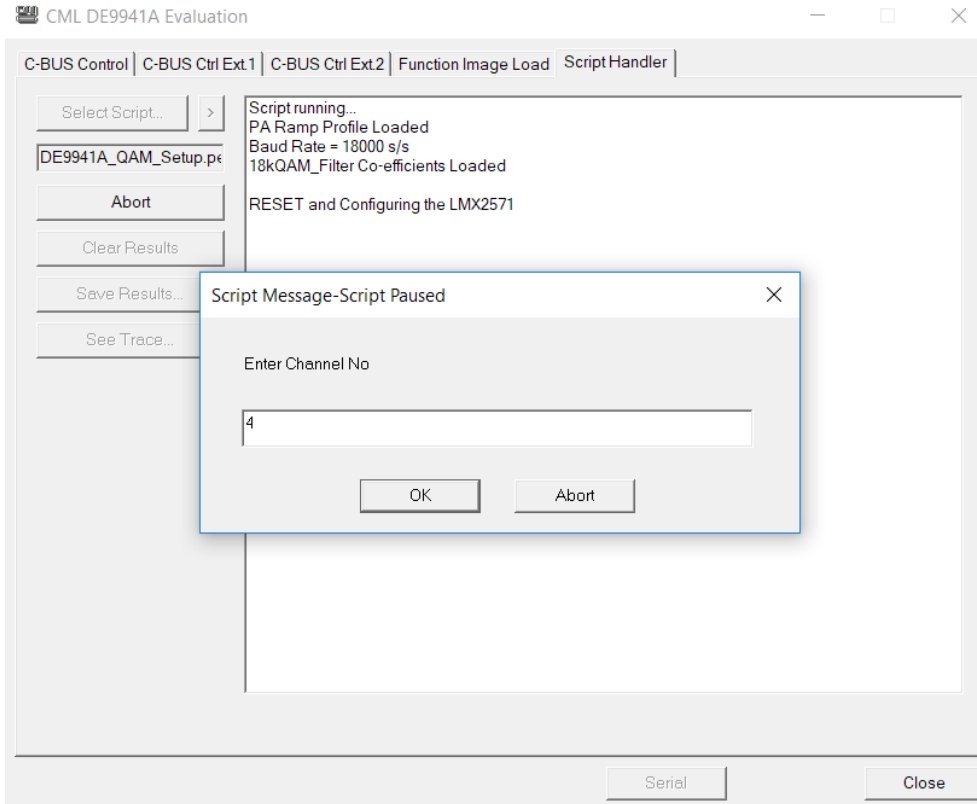

Figure 6 Setup Script Channel No Selection

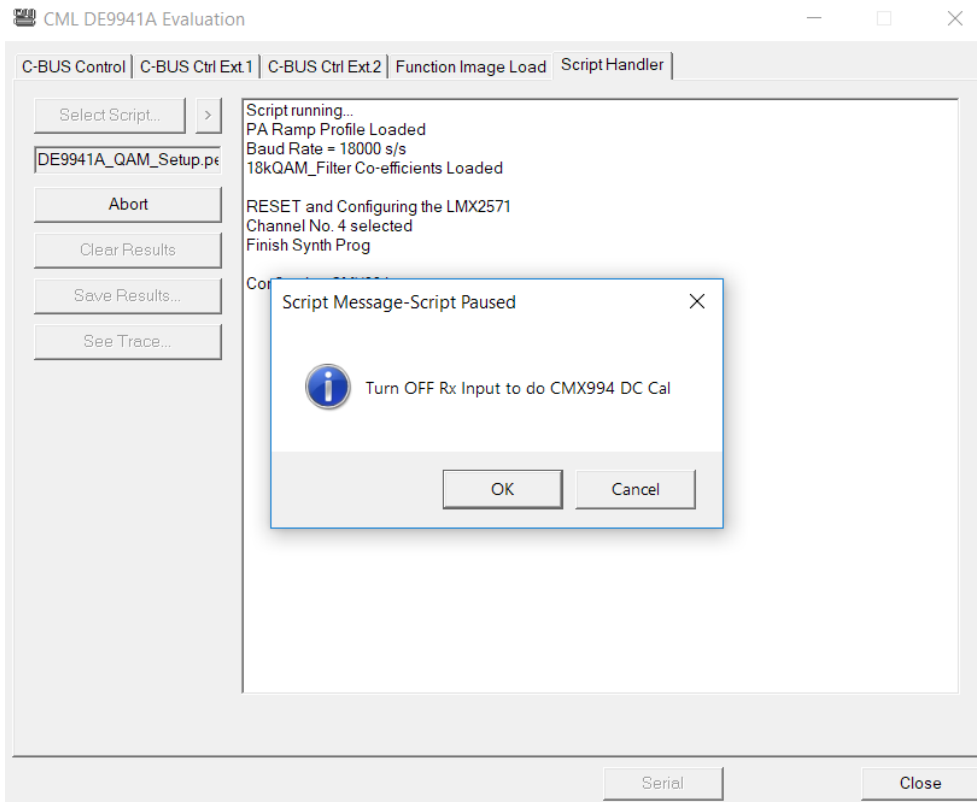

Figure 7 Setup Script User Prompt to Ensure Rx Input is OFF to Allow Rx DC Calibration

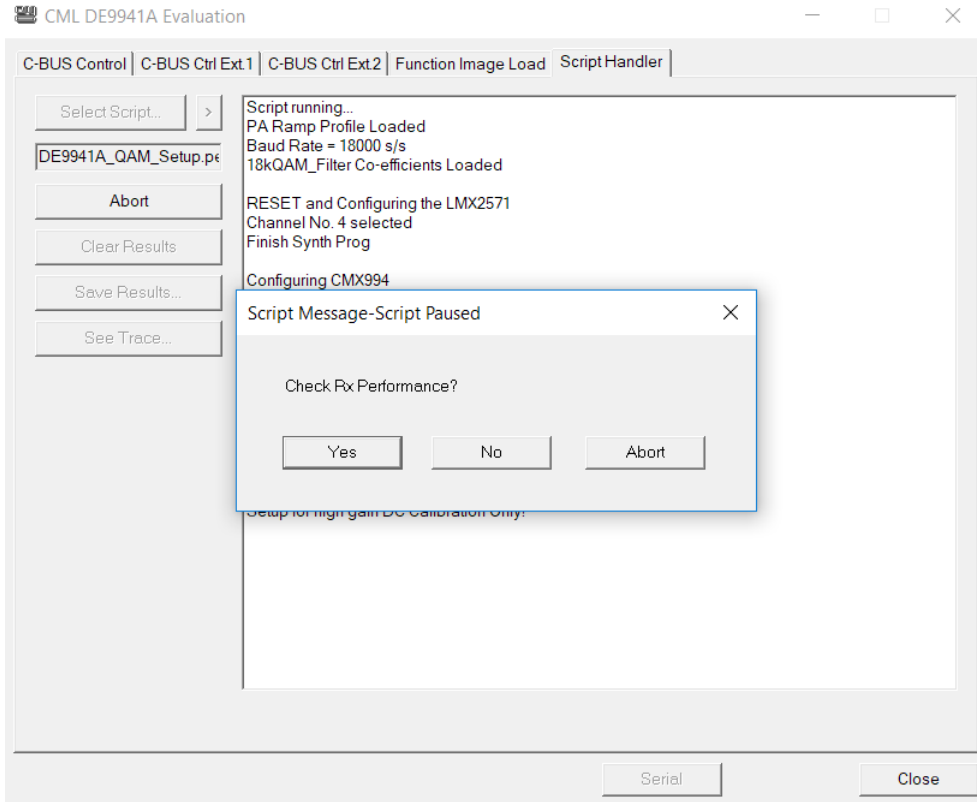

Figure 8 Setup Script User Prompt to Check Rx Performance

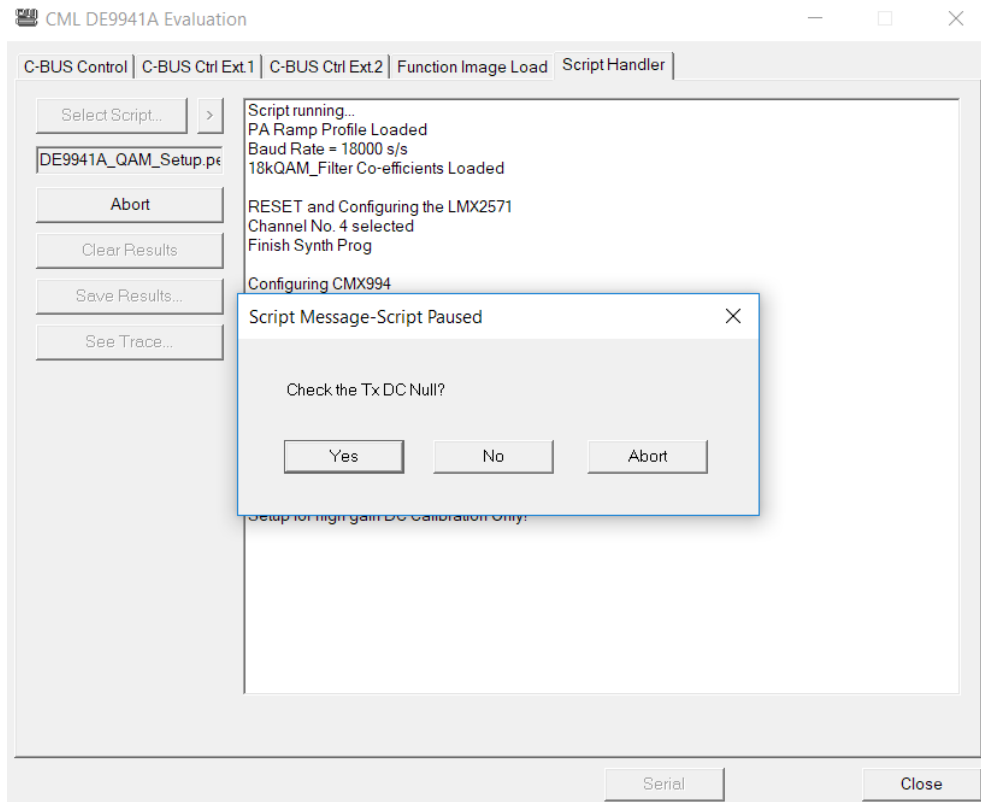

Figure 9 Setup Script User Prompt to Check Tx Null Condition



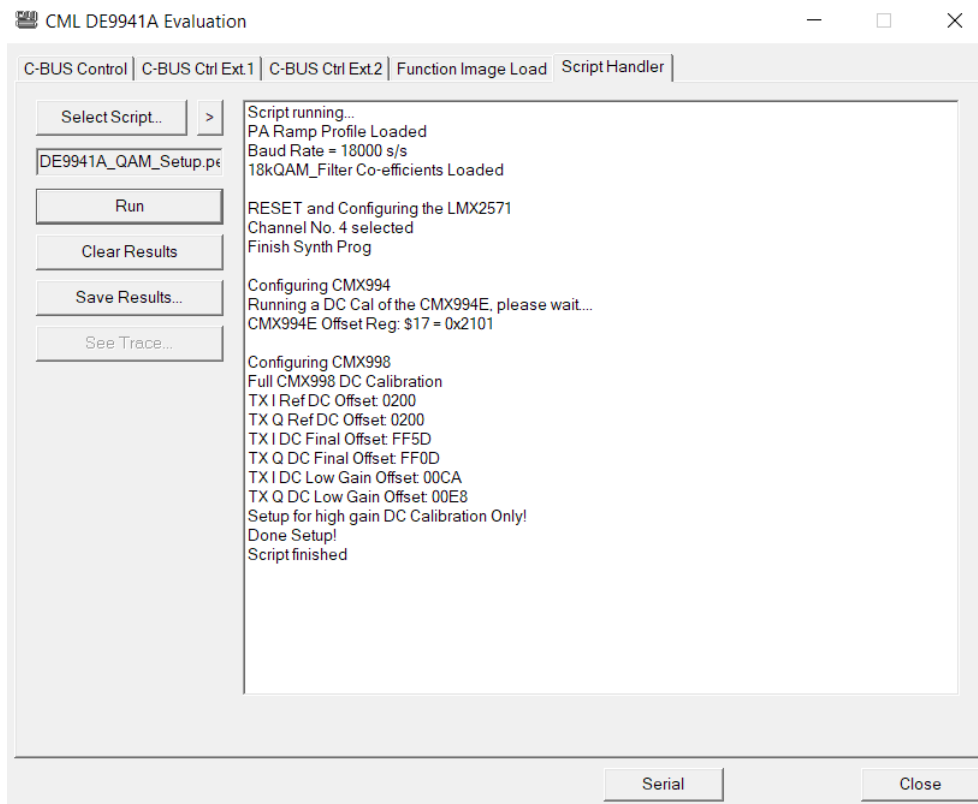

Figure 10 Setup Script Log Screen after Script has completed

#### ***DE9941A\_QAM\_RX and DE9941A\_QAM\_TX***

At the top of the scripts the user can select whether to test with raw or coded data (0 = raw/non-coded and 1 = coded) and how many bursts to do the test over.

Based on a back-to-back test the Rx script is run first and it will prompt the user if they want to enable AGC, see Figure 11. The Tx script is then run and the user will be prompted to choose the desired modulation type to be sent, this can be 4, 16, 32 or 64 QAM, see Figure 12 which shows a screenshot of the Tx script prompt.

Following successful reception and transmission the log screens shown in Figure 13 and Figure 14 can be observed. The results of the complete test are also written to a text file (ber\_results.txt) in the same directory as the scripts are stored; a screenshot of a typical txt file output is shown in Figure 15. From this the user can see confirmation of the test scenario alongside the reported EVM (signal quality), frequency offset, BE (bit errors per burst), A (AGC setting; 7 = max gain to 0 = min gain), RSSI (in dBm), IQ DC offsets and T (timer) per bursts plus the total errors.

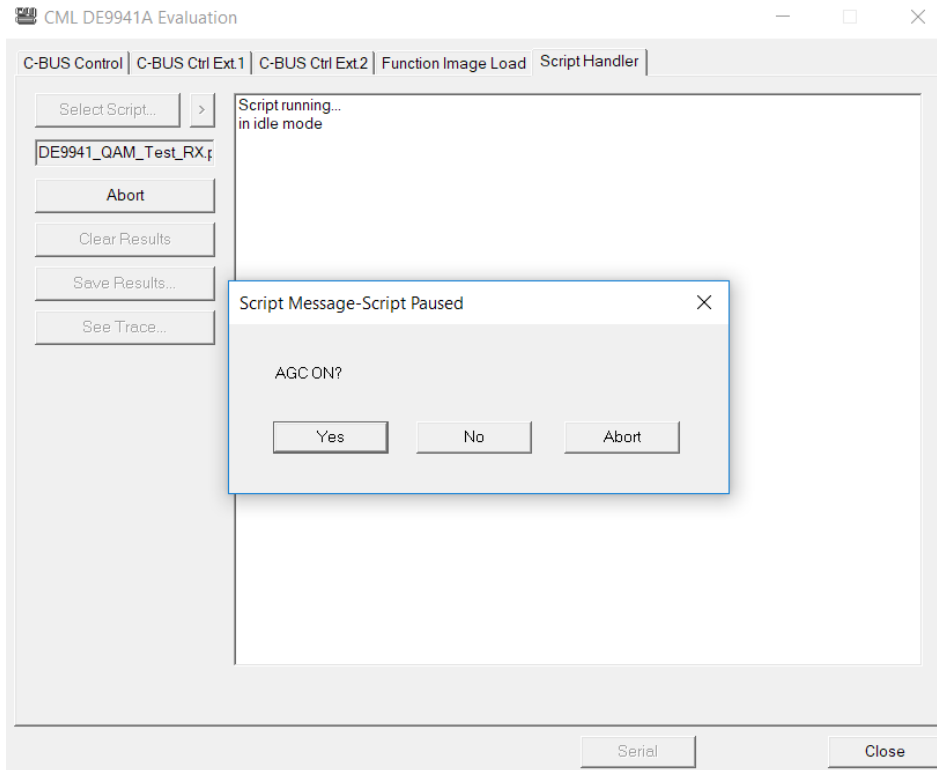

Figure 11 Rx Script User Prompt to Enable AGC

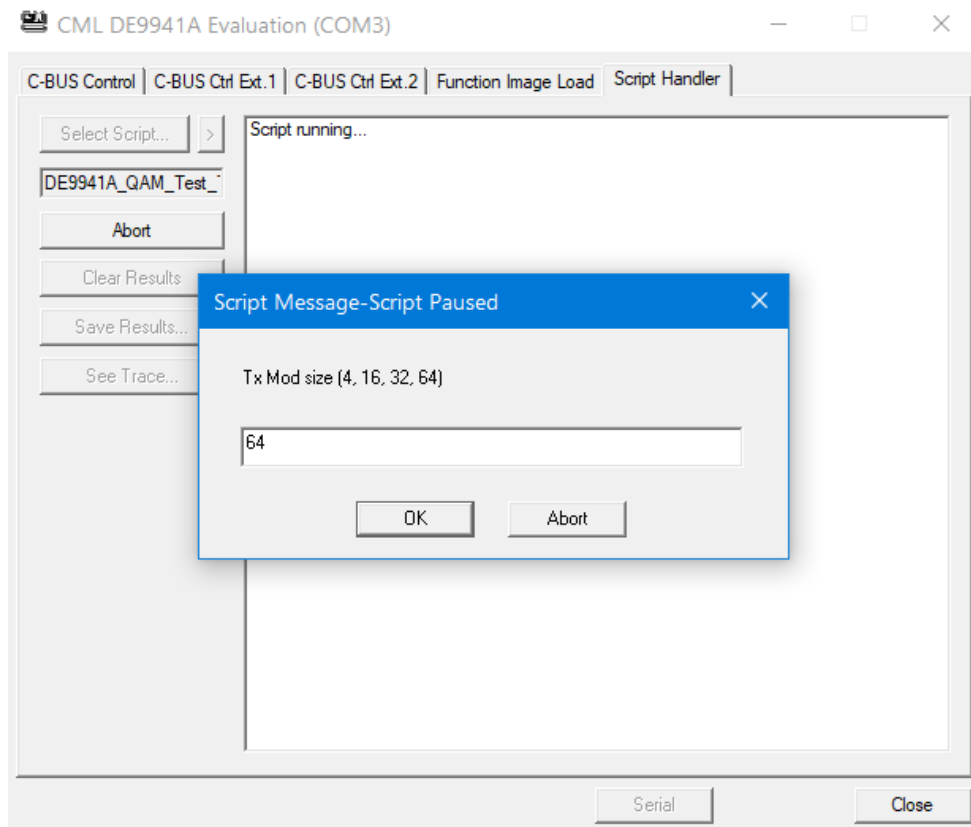

Figure 12 Tx Script User Prompt to Select Modulation Type to Send (4, 16, 32 or 64)

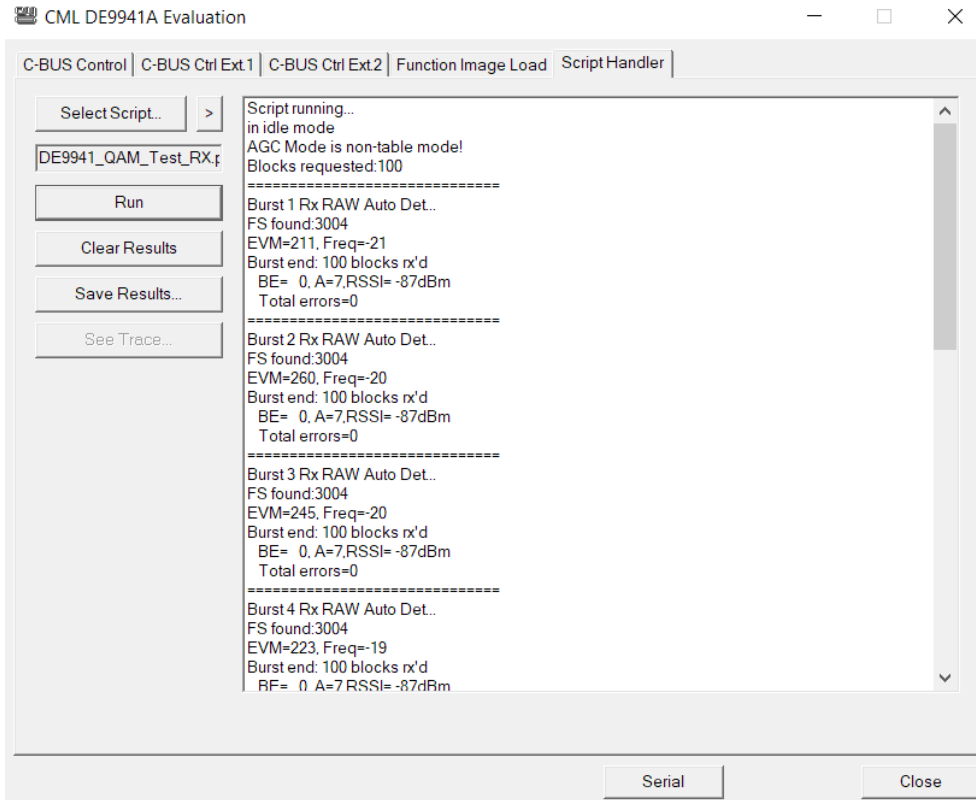

Figure 13 Rx Script Log Screen Following Successful Reception

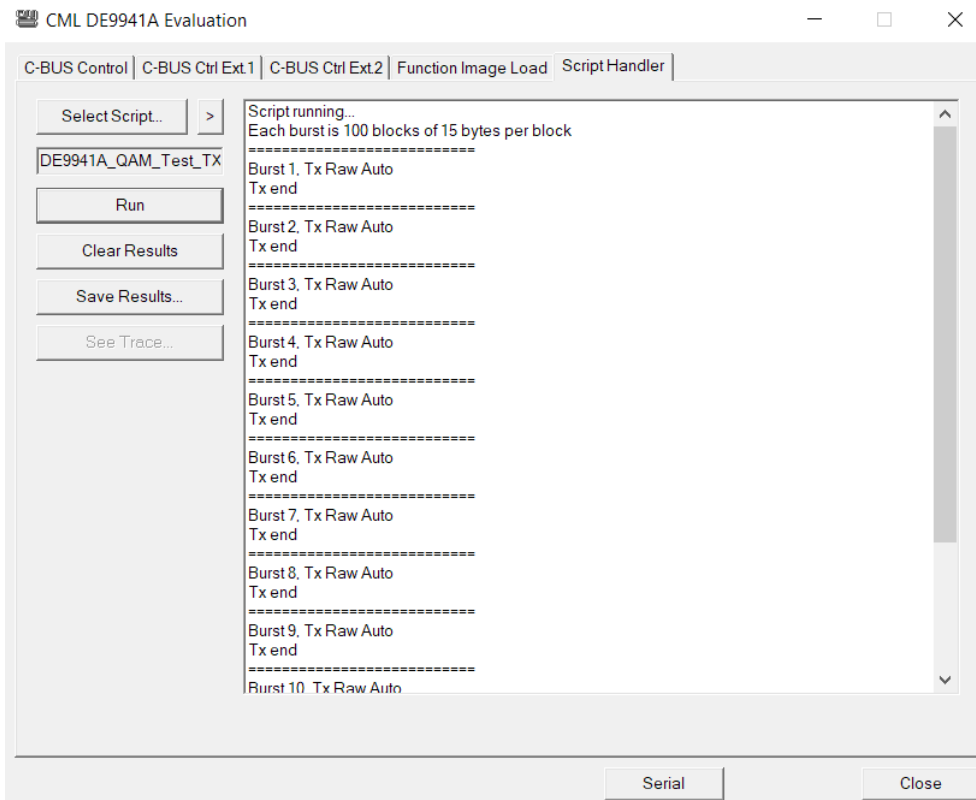

Figure 14 Tx Script Log Screen Following Successful Transmission

```

ber_results - Notepad
File Edit Format View Help
BER test start
;*****
Sig controls: $8003
Sig controls: $9500
Sig controls: $e040
Sig controls: $c080
Sig controls: $d07a
RAW Mode
=100*15*8 per run
Rx Auto QAM Detect...

FS found:3004, EVM=199, Freq=-19, BE= 0, A=7,RSSI= -87dBm, DC=-128, -141, T=3525
FS found:3004, EVM=221, Freq=-19, BE= 0, A=7,RSSI= -87dBm, DC=-129, -142, T=876
FS found:3004, EVM=251, Freq=-17, BE= 0, A=7,RSSI= -87dBm, DC=-129, -143, T=876
FS found:3004, EVM=258, Freq=-18, BE= 0, A=7,RSSI= -87dBm, DC=-129, -142, T=877
FS found:3004, EVM=262, Freq=-19, BE= 0, A=7,RSSI= -87dBm, DC=-128, -141, T=876
FS found:3004, EVM=199, Freq=-19, BE= 0, A=7,RSSI= -87dBm, DC=-126, -144, T=876
FS found:3004, EVM=204, Freq=-18, BE= 0, A=7,RSSI= -87dBm, DC=-126, -142, T=876
FS found:3004, EVM=188, Freq=-19, BE= 0, A=7,RSSI= -87dBm, DC=-128, -143, T=876
FS found:3004, EVM=216, Freq=-17, BE= 0, A=7,RSSI= -87dBm, DC=-129, -145, T=877
FS found:3004, EVM=198, Freq=-18, BE= 0, A=7,RSSI= -87dBm, DC=-127, -144, T=876
Total errors=0
    
```

Figure 15 Typical ber\_results.txt file Output From the Rx

**7.3.4 Typical Receiver Results with CMX7364 FI-4**

The Receiver Response Equaliser within the CMX7364 has been used in single mode to create a channel filter that has compensation for the ADCs and also the channel filtering within the Rx chain. The AAF (Anti-Alias filter in the CMX7364) is at its default setting of 50kHz, 3dB bandwidth. The ACR (Adjacent Channel Rejection) filters on the CMX994E are in the intermediate bandwidth state (typically 8kHz -3dB bandwidth).

In all of the following results the data rate is 18 ksymbols/s and, in the following table, the raw over-air bit rate for the three different modulation types have been highlighted. Also, the RRC channel filter used in all cases has an alpha of 0.2. Parametric measurements and graphs shown are typical only, not guaranteed performance limits.

QAM Modulation Type	Bits per Symbol	Base Over-air Bit Rate (18 ksymbols/s)	Raw Mode Over-air Bit Rate (18 ksymbols/s)
4-QAM	2	36,000 bps	32,000 bps
16-QAM	4	72,000 bps	64,000 bps
64-QAM	6	108,000 bps	96,000 bps

The difference between the base over-air rate and the raw mode rate (which is the actual user data rate in raw mode at 18 ksymbols/second) is due to some symbols being used internally by the modem to perform channel equalisation. All measurements reference ETSI EN 300 113 (v2.2.1 – Dec 2016) specification.

All of the detailed receiver performance results were taken with a CML PE0602-7364 and a IQ Vector Signal Generator as the wanted signal.

**Sensitivity**

Table 4 shows the EN 300 113 sensitivity specification limits; these limits are to be met at a BER of  $10^{-2}$ :

**Table 4 Sensitivity levels (mean power) for different gross (on-air) bit rates in a 25kHz channel**

Channel BW	Data Rate	Sensitivity
20kHz and 25kHz	9.6 kbit/s or less	-110dBm
	More than 9.6 kbits to 38.4 kbit/s	-105dBm
	More than 38.4 kbits to 76.8 kbit/s	-98dBm
	Greater than 76.8 kbit/s	-93dBm

Sensitivity results for the DE9941A for 4-QAM, 16-QAM and 64-QAM are shown in Figure 16; the results were taken at 366.5MHz. It can be seen that there is significant margin on the EN 300 113 limits above.

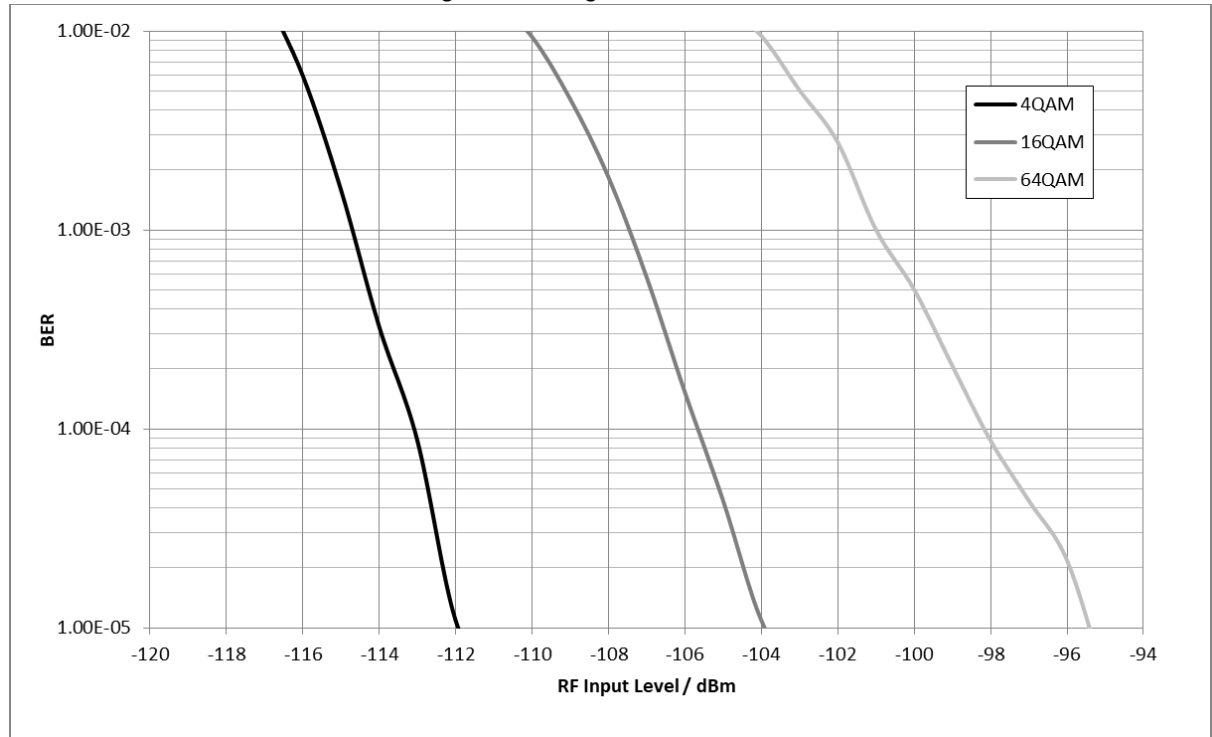

**Figure 16 Rx Sensitivity with 4-QAM, 16-QAM and 64-QAM at 18 ksymbols/s**

Figure 17 shows the 4-QAM sensitivity performance at the top, middle and bottom of the frequency range; channel 16, 8 and 1 respectively.

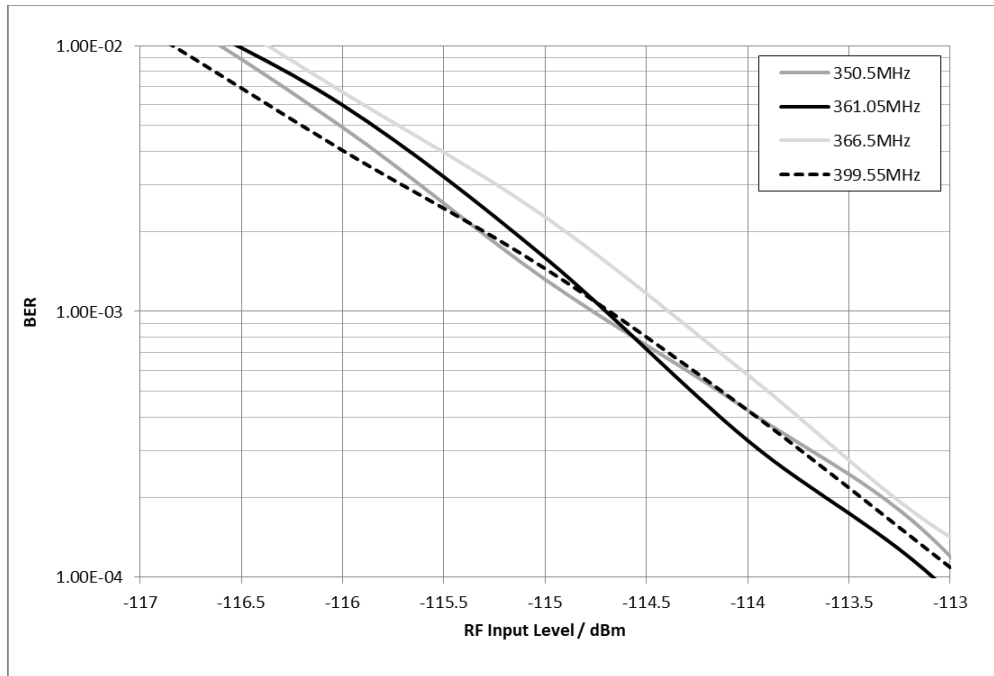

Figure 17 Rx Sensitivity at Different Frequencies with 4-QAM, 18 ksymbols/s

**Adjacent Channel Rejection**

The adjacent channel rejection was measured with the wanted signal at -102dBm (i.e. 3dB above the limited specified in Table 4) and the unwanted signal FM modulated (400Hz tone at +/- 3kHz deviation) at +/-25kHz offset. EN 300 113 states that a BER of less than  $10^{-2}$  should be achieved with an interferer level of -37dBm. The results in Table 5 show that this limit can be met with 4-QAM modulation, with ~4dB margin and the result is identical on the -25kHz offset.

Table 5 4-QAM Rx Adjacent Channel Rejection with a FM Interferer at +/-25kHz Offset

Interferer Level (dBm)	+25kHz Offset
	BER
-37	4.36E-05
-36	6.21E-04
-35	1.67E-03
-34	2.91E-03
-33	6.29E-03
-32	1.31E-02

The results in Table 6 show that this limit can be met with 16-QAM modulation, with ~4dB margin.

**Table 6 16-QAM Rx Adjacent Channel Rejection with FM Interferer at +/-25kHz offset**

Interferer Level (dBm)	+25kHz Offset
	BER
-37	2.94E-04
-36	4.79E-04
-35	1.48E-03
-34	3.26E-03
-33	6.00E-03

The results in Table 7 show that this limit can be met with 64-QAM modulation, with ~4dB margin.

**Table 7 64-QAM Rx Adjacent Channel Rejection with a FM Interferer at +/-25kHz offset**

Interferer Level (dBm)	+25kHz Offset
	BER
-37	1.58E-03
-36	2.43E-03
-35	4.50E-03
-34	6.49E-03
-33	1.14E-02

### **Co-Channel Rejection**

The co-channel rejection was measured with the wanted signal 3dB above the limits specified in Table 4 and the unwanted signal FM modulated (400Hz tone +/- 3kHz deviation) on frequency.

EN 300 113 co-channel specification limits are as follows and these limits are to be met at a BER of  $10^{-2}$ :

**Table 8 Co-channel Performance for different gross (on-air) bit rates**

Channel BW	Data Rate	Co-channel
25kHz	9,6 kbit/s or less	-8dB
	More than 9,6 kbits to 38,4 kbit/s	-12dB
	More than 38,4 kbits to 76,8 kbits	-19dB
	Greater than 76,8 kbit/s	-24dB

The results for 4-QAM, 16-QAM and 64-QAM co-channel performance are shown in Figure 18. It can be seen that the EN 300 113 can be met in all cases with more than 3dB margin.

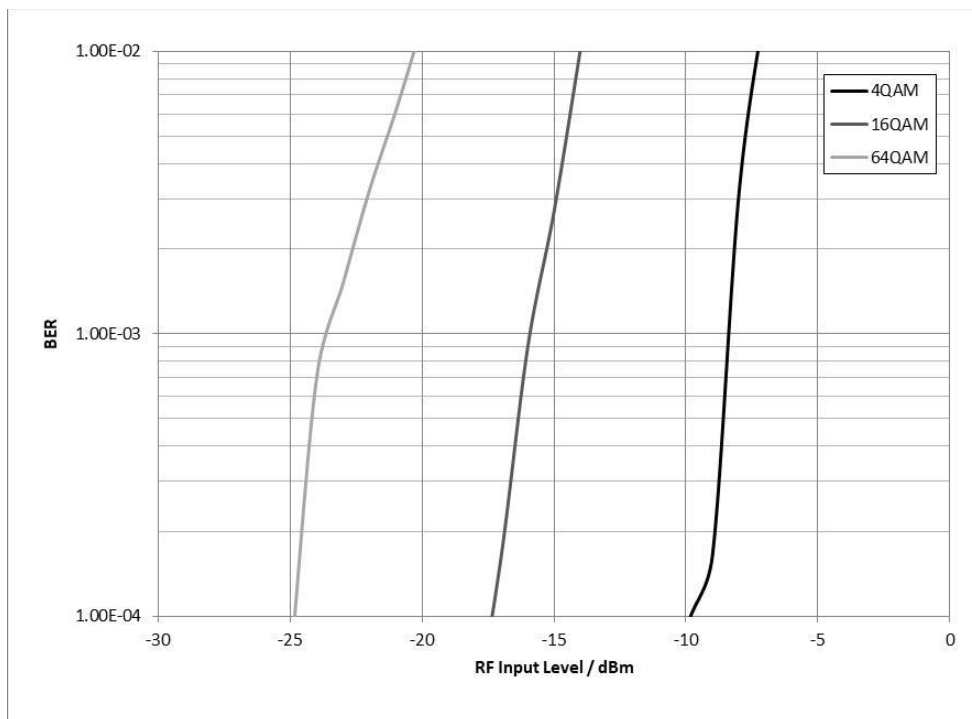

Figure 18 4-QAM, 16-QAM and 64-QAM Co-Channel Performance

**Intermodulation**

Intermodulation was measured against EN 300 113, which specifies that the wanted tone is 3dB above the limit specified in Table 4 and the spacing between the unwanted tones is 50kHz. The first unwanted tone was at +/-50kHz offset from wanted and was un-modulated. The second unwanted tone was at +/-100kHz offset and was FM modulated with a 400Hz tone at +/-3kHz deviation. The EN 300 113 limit is at an unwanted tone level of -42dBm for handportable and mobile stations at a BER of less than 10<sup>-2</sup>. The results for 4-QAM are given in Table 9: they show the EN 300 113 can be met comfortably. In normal IP3 mode the EN 300 113 requirement for hand portable and mobile stations can still be met with ~1 to 2dB margin.

Table 9 Rx Intermodulation Performance for 4-QAM in Enhanced IP3 mode

Interferer Level (dBm)	BER	Separation (dB)
-40	2.40E-04	62
-39	1.00E-03	63
-38	2.77E-03	64
-37	8.56E-03	65
-36.5	1.40E-02	65.5

**Blocking and Spurious Response Rejection**

The wanted 4-QAM signal level was -102dBm and an interferer was generated by the SMW200A Low Noise Signal Generator, which was FM modulated for the spurious response tests or unmodulated for the blocking tests. The EN 300 113 spurious response interferer level limit is -37dBm with the wanted signal 3dB up from the sensitivity level in Table 4, the BER must be less than 10<sup>-2</sup>. The EN 300 113 blocking requirement is to have a BER less than 10<sup>-2</sup> at an interferer level of -23dBm. The results show that in the 4-QAM mode, the EN 300 113 limits are met comfortably.



Table 10 4-QAM Rx Spurious Response and Blocking Performance

Offset of Interferer (Hz)	Interferer Level (dBm)	BER	Comment
50k	-33		Modulated
75k	-33.5		Modulated
100k	-33.5		Modulated
125k	-33.5		Modulated
150k	-33		Modulated
500k	-23		Modulated
1M	-15		Modulated or Unmodulated
-180.525M	-33		Modulated. The 2 <sup>nd</sup> harmonic of the interferer must be less than -115dBm to ensure it doesn't act like a co-channel signal
361.05M	0		Modulated
2M	-12		Unmodulated
5M	-9		Unmodulated
10M	-9		Unmodulated

**Rx Conducted Spurious**

All spurious are below -80dBm up to 1GHz.

**High Input Level Performance**

With AGC ON in the CMX7364, the receiver can be seen to work up to 0dBm with 4-QAM modulation.

**7.3.5 Typical Transmit Performance with CMX7364 FI-4**

The signal spectrum is identical in bandwidth when using 4-, 16- or 64-QAM. However, the peak-to-mean of each modulation type does vary.

4-QAM has a peak to mean of 5.2dB ( $\alpha=0.2$ ) or 3.8dB ( $\alpha=0.35$ )  
 16-QAM has a peak to mean of 6.8dB ( $\alpha=0.2$ ) or 5.8dB ( $\alpha=0.35$ )  
 64-QAM has a peak to mean of 7.3dB ( $\alpha=0.2$ ) or 6.3dB ( $\alpha=0.35$ )

Table 11 shows some typical measurements at 366.5MHz, with the different QAM and channel filter types at 18 ksymbols/s. Parametric measurements and graphs shown are typical only, not guaranteed performance limits.

Table 11 Tx Performance at 366.5MHz with different QAM and Channel Filter Types

	DAC Atten Value B4 & B5 (hex)	Mean O/P Power (dBm)	1 <sup>st</sup> ACP (dBc)	EVM (%)
<b>RRC alpha = 0.2</b>				
4-QAM	18	25.2	66/67	0.85
16-QAM	16	23.4	66/67	0.87
64-QAM	14	23.1	66	1.2
<b>RRC alpha = 0.35</b>				
4-QAM	10	26.9	65/66	0.53
16-QAM	D	25.2	65/66	0.56
64-QAM	D	24.5	65/66	1.05

Some further detailed results have been taken with 16-QAM modulation at 18ksymbols/s, with a RRCalpha = 0.2. These results are shown in the following sections.

**16-QAM ACP**

The plot in Figure 19 was taken at 350.05MHz, Figure 20 is at 366.5MHz and Figure 21 is at 399.55MHz with a baud rate of 18 ksymbols/s. In all cases the mean output power is >+23dBm. Note that this includes ~1.2dB loss through the Tx/Rx switch, harmonic filter/coupler. The peak to mean of 16-QAM is ~6.8dB, based on a RRC alpha = 0.2 channel filter. A summary of results is shown in Table 12. There are also plots of 16-QAM at different baud rates, the plot in Figure 22 is with a baud rate of 9.6 ks/s and the plot in Figure 23 is with a baud rate of 40 ks/s.

**Table 12 Summary of 16-QAM Tx Output Power and ACP Performance**

	350.05MHz	366.5MHz	399.55MHz
Mean output power	+23.8dBm	+23.54dBm	+23.9dBm
1 <sup>st</sup> ACP	66dBc	66dBc	65dBc
2 <sup>nd</sup> ACP	75dBc	75.5dBc	75dBc
EVM	0.7 %	0.87 %	0.78 %

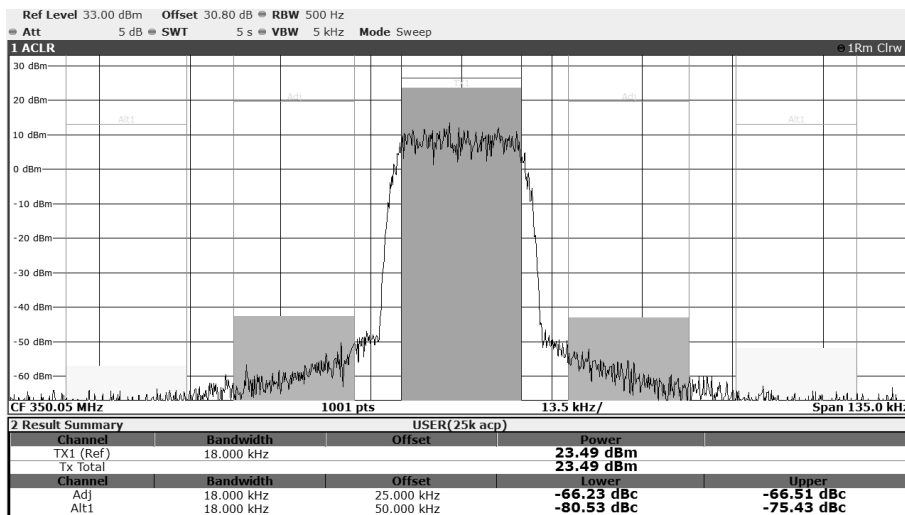

**Figure 19 16-QAM, 18 ks/s, ACP Performance at 350.05MHz**

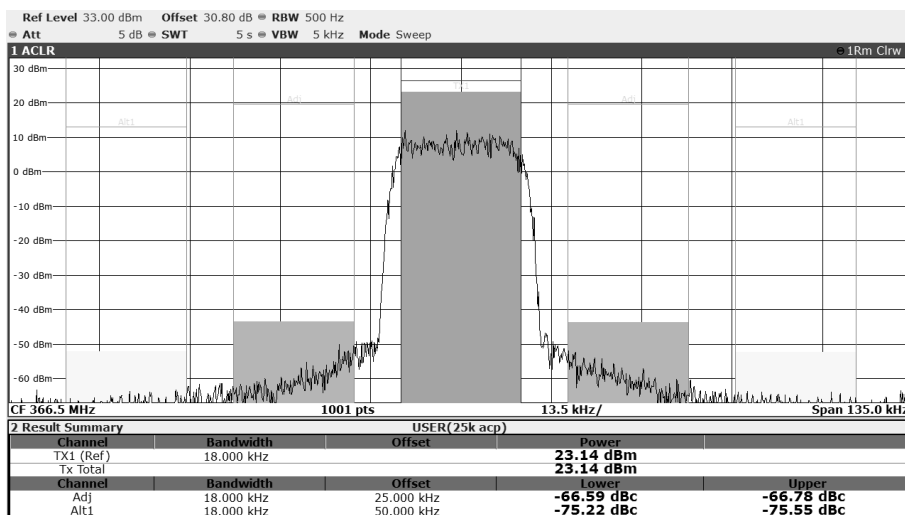

**Figure 20 16-QAM, 18 ks/s, ACP Performance at 366.5MHz**

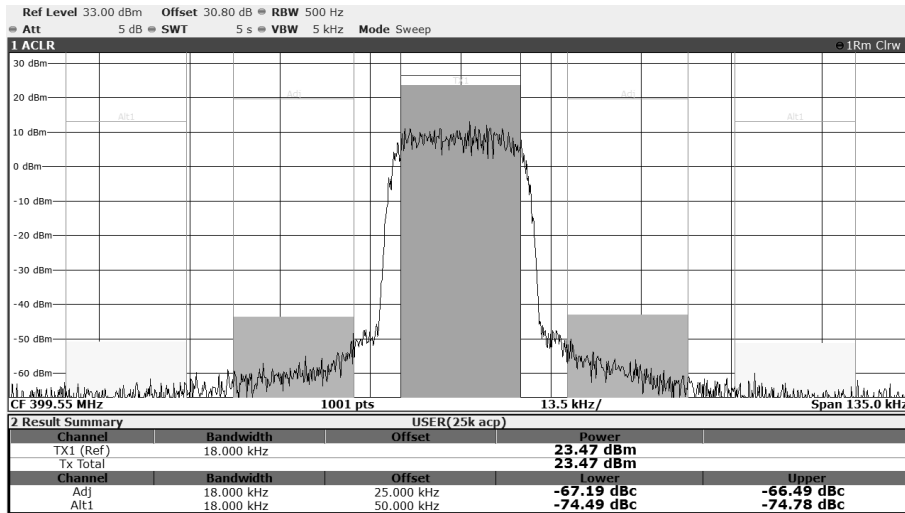

Figure 21 16-QAM, 18 ks/s, ACP Performance at 399.55MHz

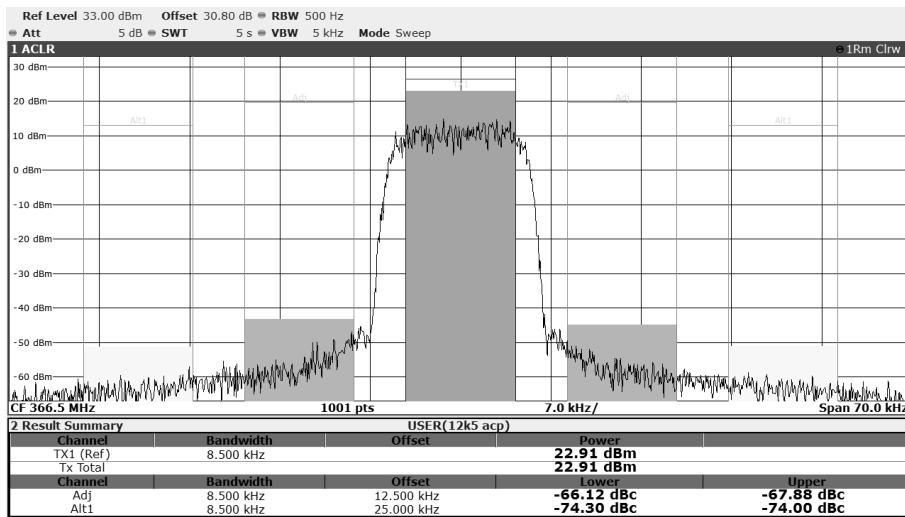

Figure 22 16-QAM, 9.6 ks/s, ACP Performance at 366.5MHz

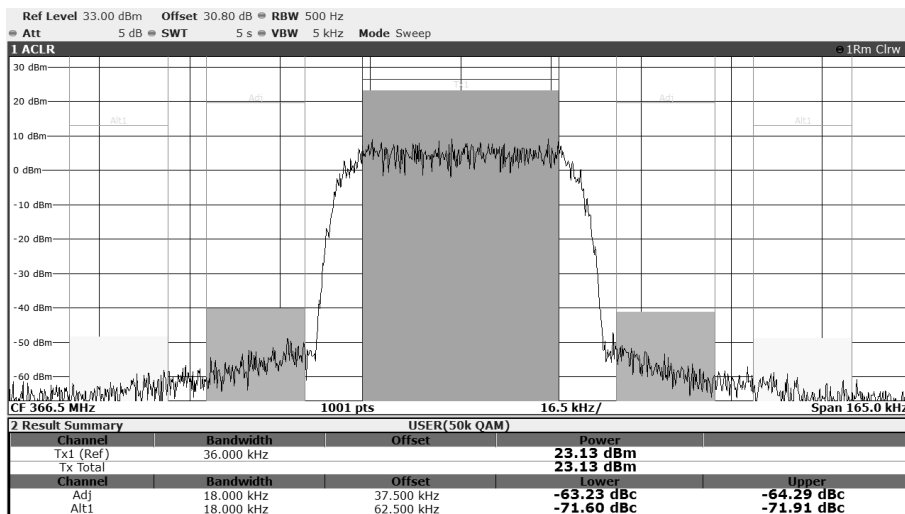

Figure 23 16-QAM, 40 ks/s, ACP Performance at 366.5MHz

**16-QAM Constellation and EVM**

In Figure 24 to Figure 26 there are plots of the DE9941A Tx output at 366.5MHz at different baud rates, showing the resultant constellation and EVM.

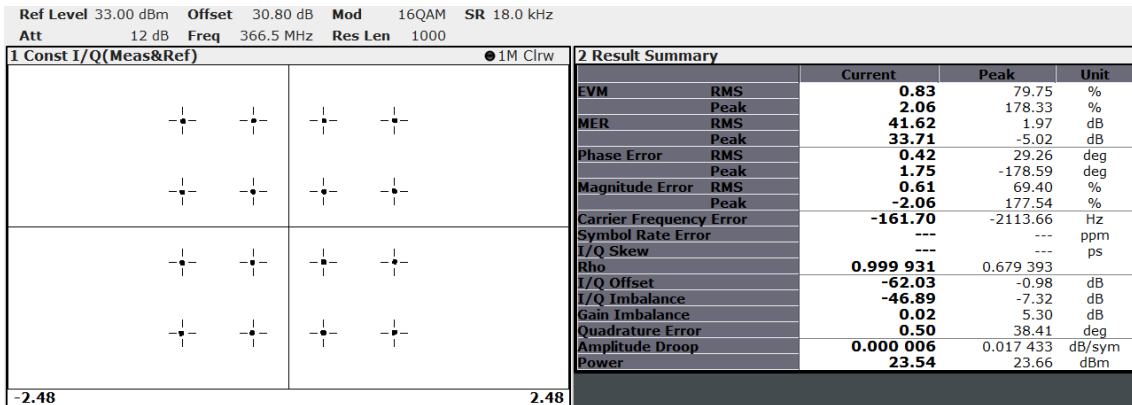

Figure 24 16-QAM, 18 ks/s, Constellation and EVM at 366.5MHz

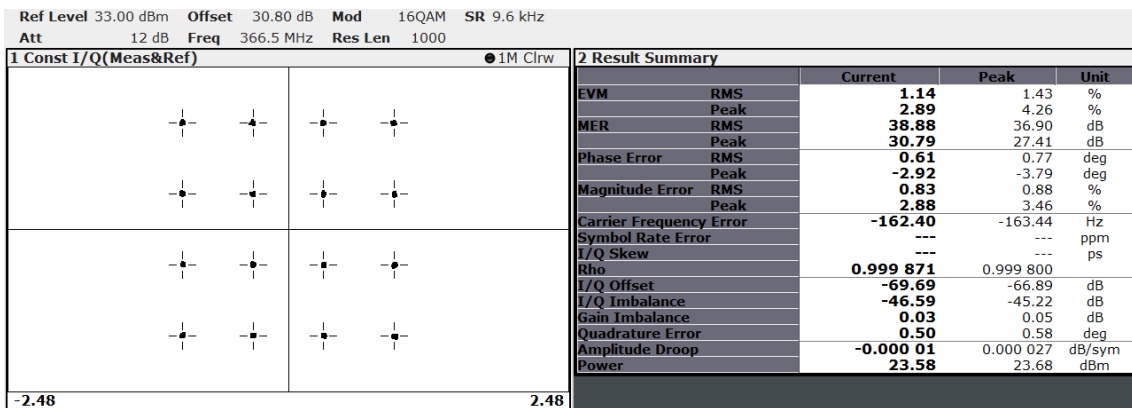

Figure 25 16-QAM, 9.6 ks/s, Constellation and EVM at 366.5MHz

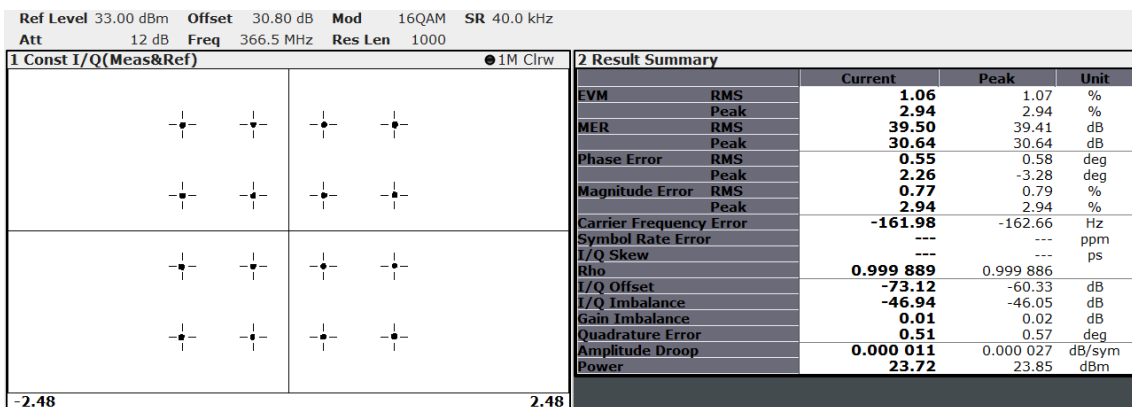

Figure 26 16-QAM, 40 ks/s, Constellation and EVM at 366.5MHz

**Transmit Harmonics and Spurious**

The following pairs of plots show the DE9941A Tx output at the low (350.05MHz), mid (366.5MHz) and upper (399.55MHz) points of the operating frequency. At each frequency, the plots are taken with a wide span. In all cases the main spurious is the 2<sup>nd</sup> harmonic.

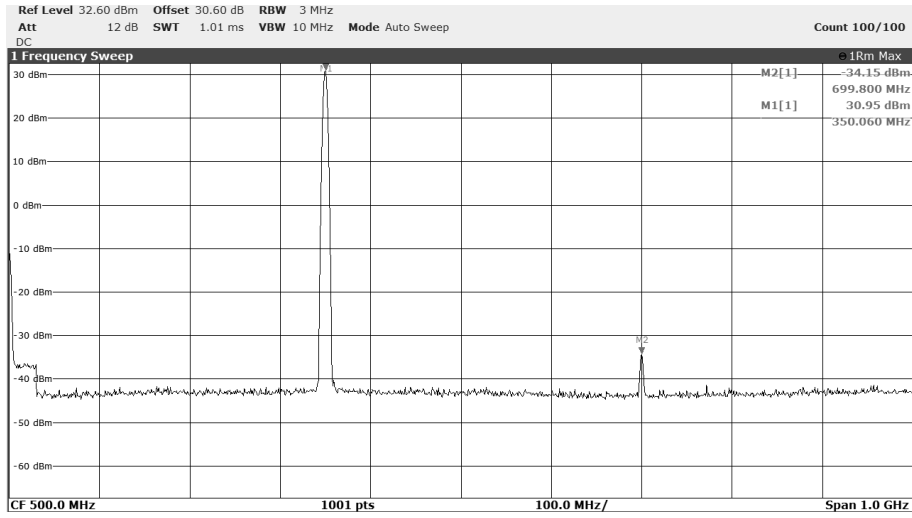

Figure 27 Wideband Plots of Tx at 350.05MHz

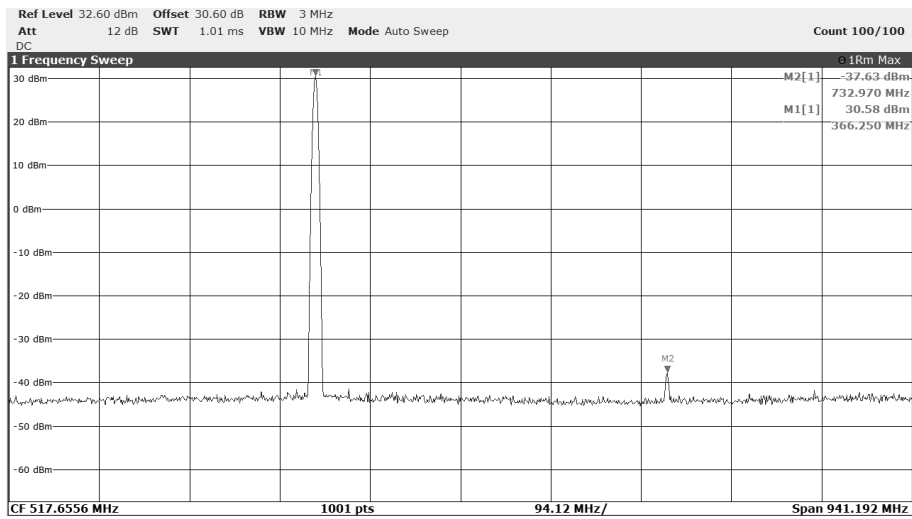

Figure 28 Wideband Plots of Tx at 366.5MHz

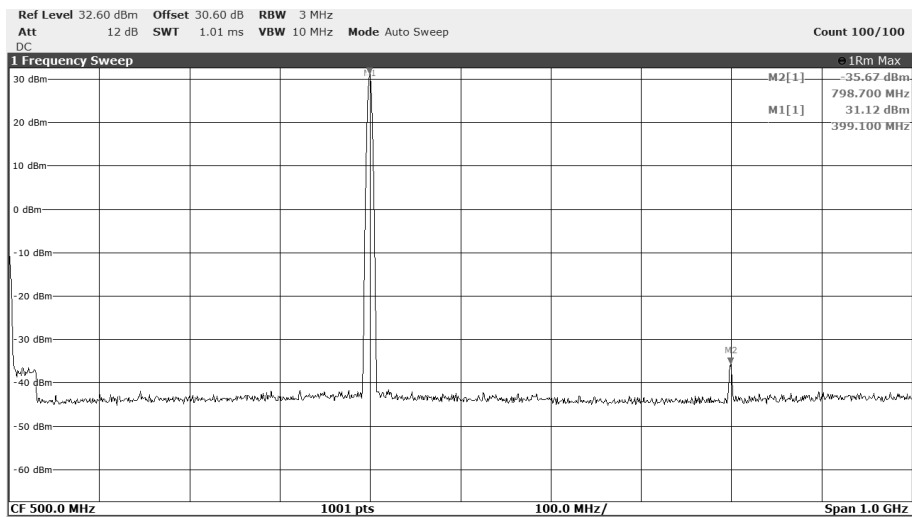
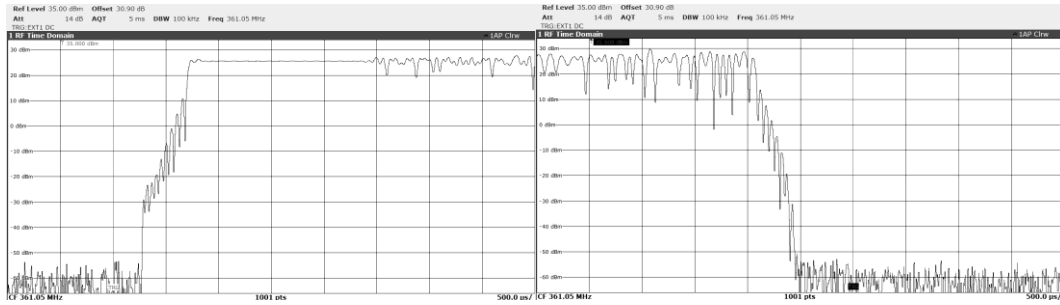

Figure 29 Wideband Plots of Tx at 399.55MHz

**Power and Modulation Ramping**

Plots in Figure 30 and Figure 31 show the ramp-up and ramp-down profiles using QAM and the plots in Figure 31 to Figure 33 show the spectral purity using max hold on the traces for 100 bursts transmitted.



**Figure 30 Ramp-up and Ramp-down Profile (QAM)**

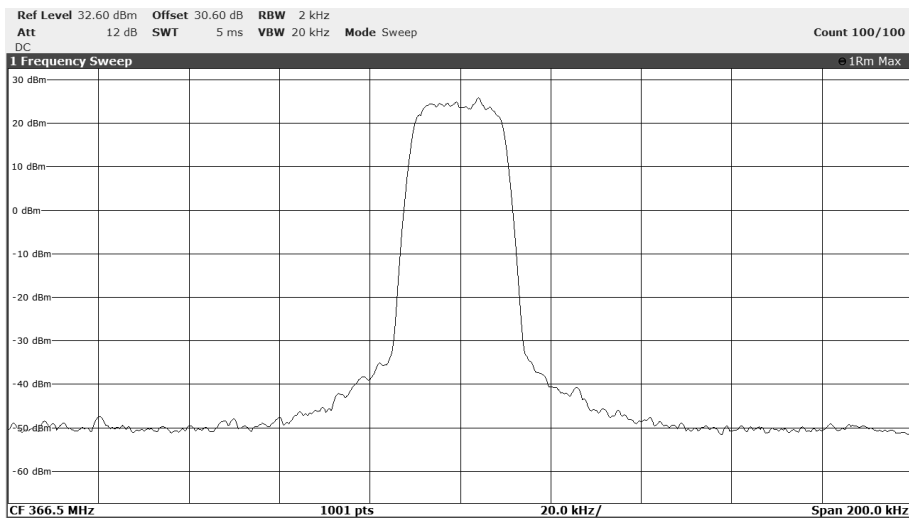

**Figure 31 Tx Spectral Purity in Transient Mode, 200kHz Span (QAM)**

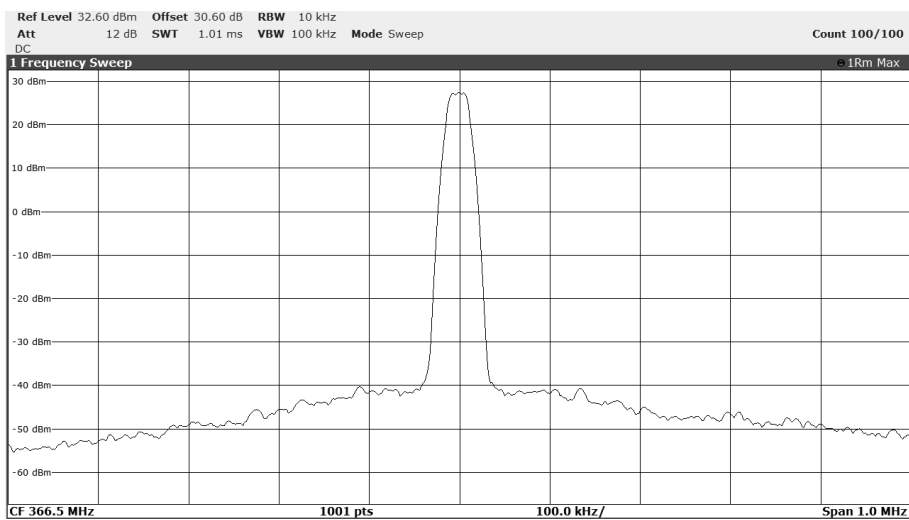

**Figure 32 Tx Spectral Purity in Transient Mode, 1MHz Span (QAM)**

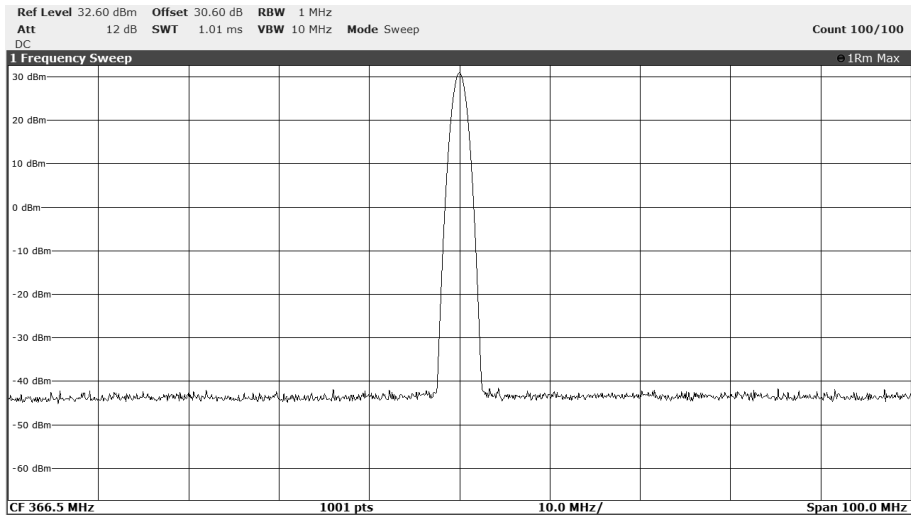

Figure 33 Tx Spectral Purity in Transient Mode, 10MHz Span (QAM)

## 7.4 Troubleshooting

The DE9941A is a complex RF and baseband system. If incorrectly programmed or modified, results will be at variance from datasheet performance. Please study the CMX7364, CMX998 and CMX994E datasheets, along with the manuals and the associated schematics and layout drawings for these and the DE9941A PCB carefully when troubleshooting. This section provides suggestions to help users resolve application issues they might encounter.

### 7.4.1 Receiver Operation

**Table 13 Receiver - Possible Errors**

Error Observed	Possible Cause	Remedy
Received data is not provided by the receiver	Incorrect set-up	Ensure that suitable values are written to the CMX7364 registers concerning receiver gains and polarity. Also check the dc offsets and signal levels into the CMX7364 IQ Inputs (TP15, 16, 18 and 19).
	Incorrect set-up	The CMX994E has not been programmed correctly. Check signals as above.
	FI not loaded	Reset by cycling power. Check checksums.
Synthesiser not locked	Incorrect configuration components	Check the LMX2571 synthesiser programming data is correct.
Poor Receiver Performance	Receiver Response Equaliser configuration	Ensure single mode equaliser is being used and that training is done with a signal level of ~-65dBm.
	CMX994 DC Offset register not optimal	Check DC offset between I+ & I- and Q+ & Q- to be less than 15mV with nominal Rx settings, maximum Rx gain and no RF signal applied.

### 7.4.2 Transmitter Operation

**Table 14 Transmitter - Possible Errors**

Error Observed	Possible Cause	Remedy
Synthesiser not locked	Incorrect configuration components	Check that the LMX2571 synthesiser programming data is correct.
Poor Tx modulation spectrum	Modulation levels incorrect	Check CMX7364 main DAC attenuator values (B4 and B5) are correct for the QAM and Channel Filter type.
	Poor DC Calibration	Check nulled carrier condition, i.e. no modulation case. The nulled carrier should typically be <-25dBm.
Poor Wideband Spectrum	Incorrect CMX998 Loop Phase Setting	Check values sent to the CMX998 Phase control register.
Low power	PIN diode or PA not enabled	Check that the TXEN+V (TL4) power supply is enabled. Also check that the RAMDAC output is being enabled. Check PA control volts at TP23 are ~2.6/2.7V dc.



## 8 Performance Specification

### 8.1 Electrical Performance

#### 8.1.1 Absolute Maximum Ratings

Exceeding these maximum ratings can result in damage to the Evaluation Kit.

	Min.	Max.	Units
Supply ( $V_{IN} - V_{SS}$ )	0	4.5	V
Current into or out of $V_{IN}$ and $V_{SS}$ pins	0	+1.5	A
Current into or out of any other connector pin	-20	+20	mA
Receiver Maximum Input Level		+10	dBm

#### 8.1.2 Operating Limits

Correct operation of the Evaluation Kit outside these limits is not implied.

	Notes	Min.	Max.	Units
Supply ( $V_{IN} - V_{SS}$ )		3.5	4.5	V

### 8.1.3 Operating Characteristics

For the following conditions unless otherwise specified:

Xtal Frequency = 38.4MHz, Bit Rate = 18ksymbols/s,  
Noise Bandwidth = 16kHz,  $V_{IN} = 4.5V$ ,  $T_{AMB} = +25^{\circ}C$ .

	Notes	Min.	Typ.	Max.	Units
<b>DC Parameters</b>					
$I_{IN}$ (on power-up)	1	–	58	68	mA
$I_{IN}$ (FI Loaded only)	1	–	55	58	mA
$I_{IN}$ (Rx enabled)		–	165	–	mA
$I_{IN}$ (Rx enabled and SFS)		–	225	–	mA
$I_{IN}$ (Rx enabled and Rx Data)		–	210	–	mA
$I_{IN}$ (Tx and PA enabled, nulled carrier)		–	365	–	mA
$I_{IN}$ (Tx and PA enabled, modulated carrier)		–	900	1500	mA
<b>AC Parameters</b>					
Frequency Range		350.00	–	400.00	MHz
<b>Tx</b>					
Mean Output Power	2,3	–	25	–	dBm
Tx Output Impedance		–	50	–	$\Omega$
Adjacent Channel Power					
16-QAM 1 <sup>st</sup> ACP	2,3	–	66	–	dBc
16-QAM 2 <sup>nd</sup> ACP	2,3	–	75	–	dBc
Tx EVM	2	–	1	–	%
Unwanted emission	4	–	-36	–	dBm
Frequency Error		–	1.5	–	ppm
<b>Rx</b>					
Rx Input Impedance		–	50	–	$\Omega$
Rx Sensitivity	4,5				
4-QAM		–	-116	–	dBm
16-QAM		–	-110	–	dBm
64-QAM		–	-104	–	dBm
Adjacent Channel Rejection (4-QAM)	4	–	-34	–	dBm
Spurious Response (4-QAM, worst case)	4	–	-34	–	dBm
Co-Channel Rejection (4-QAM)	4	–	8	–	dB
Intermodulation, enhanced mode (4-QAM)	4	–	-37	–	dBm
Rx Conducted Spurious	4	–	< -80	–	dB
Maximum Input Level		–	0	–	dBm

#### Microcontroller Interface

For timings see CMX7364 Datasheet

#### Notes:

1. PCB current consumption, not current consumption of the CML devices.
2. Modulation 4-QAM and RRC alpha = 0.2.
3. 25kHz Channel Spacing and 18kHz Measurement Bandwidth
4. Tested as specified in EN 300 113. BER (Bit Error Rate), where applicable, is  $1 \times 10^{-2}$  in all cases in normal mode.
5. Tx/Rx Channel Filter RRC alpha = 0.2. Receiver Response Equaliser used in single mode.

CML does not assume any responsibility for the use of any circuitry described. No IPR or circuit patent licences are implied. CML reserves the right at any time without notice to change the said circuitry and any part of this product specification. Evaluation kits and demonstration boards are supplied for the sole purpose of demonstrating the operation of CML products and are supplied without warranty. They are intended for use in a laboratory environment only and are not for re-sale, end-use or incorporation into other equipments. Operation of these kits and boards outside a laboratory environment is not permitted within the European Community. All software/firmware is supplied "as is" and is without warranty. It forms part of the product supplied and is licensed for use only with this product, for the purpose of demonstrating the operation of CML products. Whilst all reasonable efforts are made to ensure that software/firmware contained in this product is virus free, CML accepts no responsibility whatsoever for any contamination which results from using this product and the onus for checking that the software/firmware is virus free is placed on the purchaser of this evaluation kit or development board.

	United Kingdom	p: +44 (0) 1621 875500	e: sales@cmlmicro.com techsupport@cmlmicro.com
	Singapore	p: +65 62888129	e: sg.sales@cmlmicro.com sg.techsupport@cmlmicro.com
	United States	p: +1 336 744 5050 800 638 5577	e: us.sales@cmlmicro.com us.techsupport@cmlmicro.com
<a href="http://www.cmlmicro.com">www.cmlmicro.com</a>			

## X-ON Electronics

Largest Supplier of Electrical and Electronic Components

*Click to view similar products for [RF Development Tools](#) category:*

*Click to view products by [CML Microcircuits](#) manufacturer:*

Other Similar products are found below :

[MAAM-011117](#) [MAAP-015036-DIEEV2](#) [EV1HMC1113LP5](#) [EV1HMC6146BLC5A](#) [EV1HMC637ALP5](#) [EVAL-ADG919EBZ](#) [ADL5363-EVALZ](#) [LMV228SDEVAL](#) [SKYA21001-EVB](#) [SMP1331-085-EVB](#) [EV1HMC618ALP3](#) [EVAL01-HMC1041LC4](#) [MAAL-011111-000SMB](#)  
[MAAM-009633-001SMB](#) [107712-HMC369LP3](#) [107780-HMC322ALP4](#) [SP000416870](#) [EV1HMC470ALP3](#) [EV1HMC520ALC4](#)  
[EV1HMC244AG16](#) [MAX2614EVKIT#](#) [124694-HMC742ALP5](#) [SC20ASATEA-8GB-STD](#) [MAX2837EVKIT+](#) [MAX2612EVKIT#](#)  
[MAX2692EVKIT#](#) [EV1HMC629ALP4E](#) [SKY12343-364LF-EVB](#) [108703-HMC452QS16G](#) [EV1HMC863ALC4](#) [EV1HMC427ALP3E](#)  
[119197-HMC658LP2](#) [EV1HMC647ALP6](#) [ADL5725-EVALZ](#) [106815-HMC441LM1](#) [EV1HMC1018ALP4](#) [UXN14M9PE](#) [MAX2016EVKIT](#)  
[EV1HMC939ALP4](#) [MAX2410EVKIT](#) [MAX2204EVKIT+](#) [EV1HMC8073LP3D](#) [SIMSA868-DKL](#) [SIMSA868C-DKL](#) [SKY65806-636EK1](#)  
[SKY68020-11EK1](#) [SKY67159-396EK1](#) [SKY66181-11-EK1](#) [SKY65804-696EK1](#) [SKY13396-397LF-EVB](#)