

Features

- CMX7x6x *FirmASIC*[®] product range evaluation
- Serial Flash Option for Function Image[™] with in-circuit programming
- On-board supply regulators operate from a single 5 volt supply
- Instrumentation interface to differential I and Q signals (requires additional -5 volt supply)
- Command and control by PC via the PE0002 interface card or user's μ C development application or emulator
- 19.2MHz oscillator, user crystal or external clock input to CMX7x6x
- On-board access to all CMX7x6x signals, commands and data
- Interfaces to RF daughterboard with all necessary signals

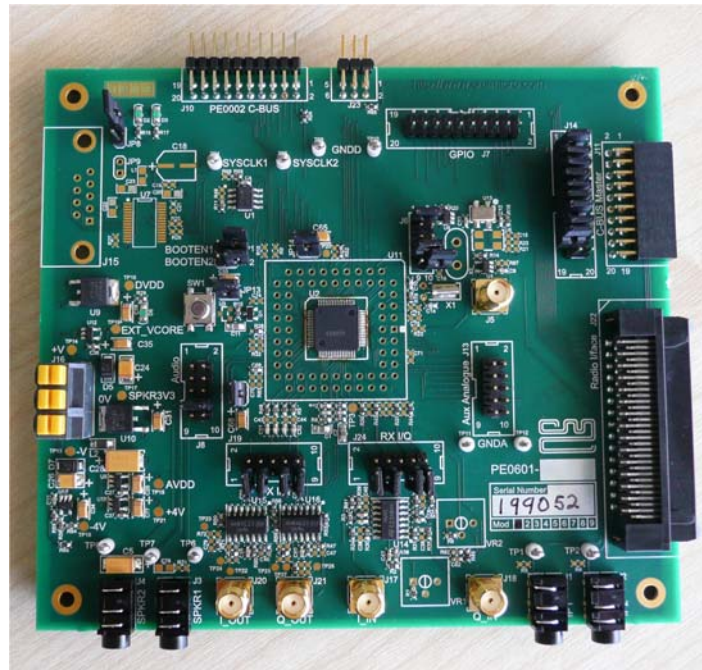

1 Brief Description

The PE0601-xxxx Platform Evaluation Kit is designed to assist in the evaluation and application development of the CMX7x6x range of *FirmASIC*[®] products. The kit is in the form of a populated PCB comprising a CMX7x6x target IC and appropriate supporting components and circuitry.

The board also incorporates all of the necessary power-supply regulation facilities for operation from a single 5 volt supply, or a dual +/-5 volt supply if the instrumentation interface is required.

The board is fitted with a C-BUS connector allowing the PE0601 to be operated by connection to either of the two C-BUS ports on a CML PE0002 Interface Card, and used with the associated PC GUI software, or by direct connection between the CMX7x6x C-BUS and the user's μ C development application or emulation system.

The CMX7x6x Function Image™ (FI) can be loaded, on power-up, directly into the on-board target IC using the PE0002 interface or the user's system. Alternatively, it can be automatically loaded from the on-board serial memory, on power-up. In this case, the on-board serial memory has to be pre-loaded with the FI by using the 'Program Serial Memory' tab on the PE0002 GUI software, or by the user's system utilising the appropriate 'thick stub' programme. All of this software is available from the CML website.

Function images suitable for the CMX7x6x range of products can be downloaded from the CML Technical Portal.

CONTENTS

<u>Section</u>	<u>Page</u>
1 Brief Description.....	1
1.1 History.....	4
2 Preliminary Information	6
2.1 Laboratory Equipment.....	6
2.2 Handling Precautions	6
2.2.1 Static Protection	6
2.2.2 Contents - Unpacking.....	6
2.3 Approvals.....	6
3 Quick Start	7
3.1 With PE0002.....	7
3.1.1 Setting-Up.....	7
3.1.2 Operation.....	7
3.2 Without PE0002.....	8
4 Signal Lists.....	9
5 Circuit Schematics and Board Layouts	20
6 Detailed Description.....	22
6.1 Hardware Description.....	22
6.1.1 Power Supplies.....	22
6.1.2 Clock Options	22
6.1.3 Control Interface	23
6.1.4 Serial Memory.....	23
6.1.5 Baseband Interfacing.....	23
6.1.6 RF Transceiver Interface.....	24
6.1.7 Instrumentation Interface.....	24
6.1.8 Digital Interfacing.....	24
6.2 Adjustments and Controls	25
6.3 Function Image™	26
6.3.1 Load Function Image™ via C-BUS	26
6.3.2 Load Function Image™ from Serial Memory Device.....	27
6.3.3 Program Serial Memory.....	28
6.4 Troubleshooting.....	30
7 Performance Specification	31
7.1 Electrical Performance	31
7.1.1 Absolute Maximum Ratings.....	31
7.1.2 Operating Limits	31
7.1.3 Operating Characteristics	32
7.1.4 Operating Characteristics - Timing Diagrams	33

<u>Table</u>	<u>Page</u>
Table 1 – Signal List.....	15
Table 2 – Test Points	16
Table 3 – Jumpers	18
Table 4 – LEDs	19
Table 5 – Clock Select Jumper Positions	22
Table 6 – TCXO Component Changes	23

<u>Figure</u>	<u>Page</u>
Figure 1 – Block Diagram	5
Figure 2 – PE0601 used with PE0002	7
Figure 3 – PCB Layout: Top	20
Figure 4 – PCB Layout: Bottom	21
Figure 5 – Function Image™ Load Tab – via C-BUS	26
Figure 6 – Function Image™ Load Tab – from Serial Memory	27
Figure 7 – Program Serial Memory Tab	28
Figure 8 – Thick Stub Loaded Message Box.....	29
Figure 9 – Program Serial Memory Complete Message Box	29

It is always recommended that you check for the latest product datasheet version from the Datasheets page of the CML website: [www.cmlmicro.com].

1.1 History

Version	Changes	Date
2	Differences in the differential signal mapping between PE0601 and various RF EvKits noted. Differences in CMX7x6x pin labelling between PE0601 and the various FI datasheets noted.	21st Apr 2011
1	Original document.	8th June 2010

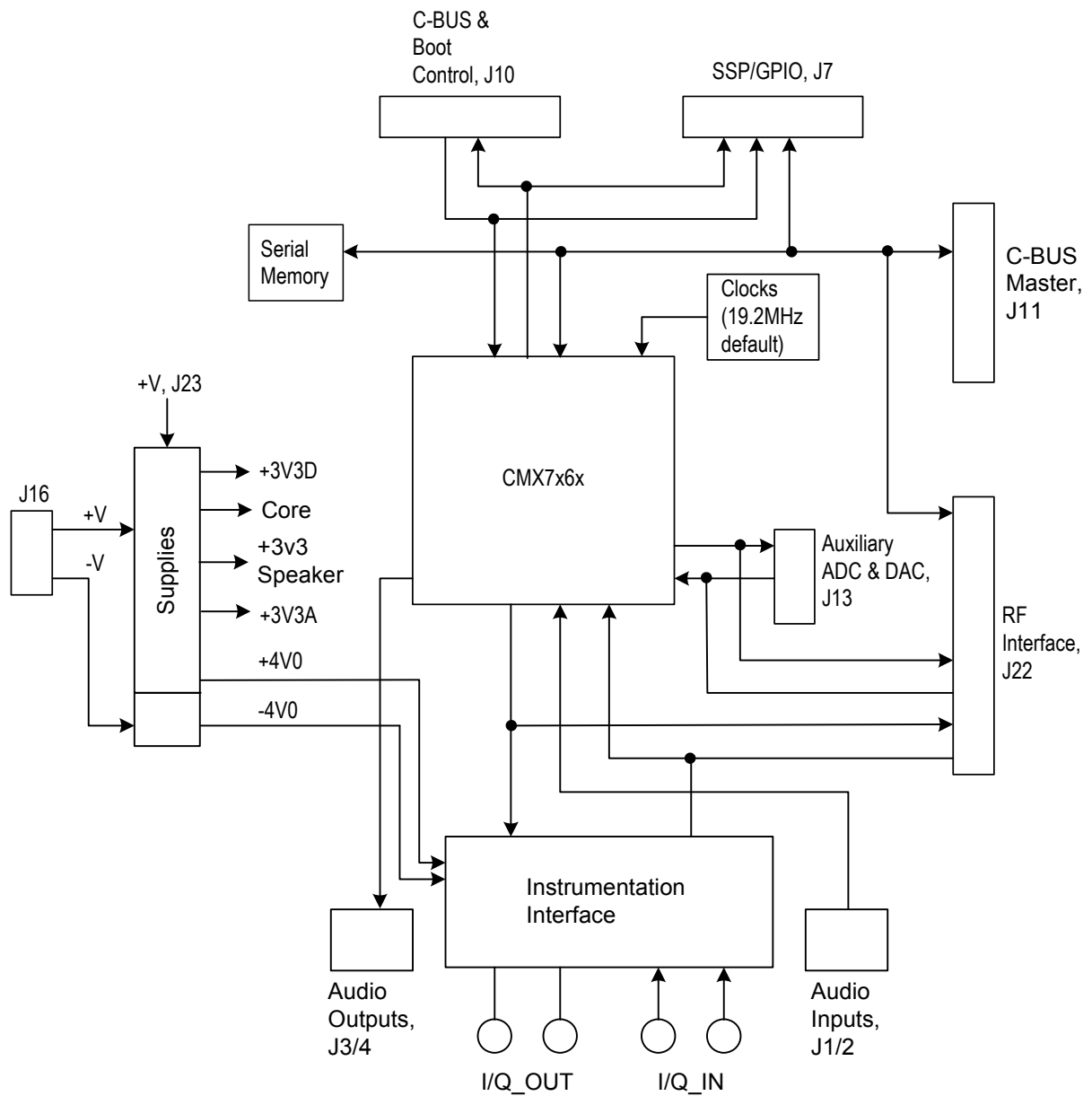

Figure 1 – Block Diagram

2 Preliminary Information

The PE0601-xxxx is designed to support the CMX7x6x range of *FirmASIC*[®] devices using their respective Function Image[™].

The PE0601-xxxx is supplied with a customer specified target device fitted where xxxx in the product code is the numerical part of the target device product code.

For example:

To evaluate a CMX7163 Function Image[™] (FI), order a PE0601-7163.

In this document the PE0601-xxxx will be referred to generically as PE0601.

Note that the Function Image[™] will redefine many pin functions and so the pins may be labelled differently, as a result. The pin numbers will remain unchanged. The datasheet and user manual appropriate to the product code and Function Image[™] should be used as the definitive reference of functionality, rather than this PE0601 document, which only uses generic pin names.

2.1 Laboratory Equipment

The following laboratory equipment is needed to use this evaluation kit:

A 5 volt dc regulated power supply or +/- 5 volt if the instrumentation interface is required.

If the PE0601 is being used with the PE0002 Interface Card, the following items will also be required:

1. An IBM compatible PC with the following requirements:
 - One of the following Windows operating systems installed: 2000sp4 or XPsp2
 - USB port
 - Minimum screen resolution 800 x 600. Recommended resolution 1024 x 768.
2. A USB type A male to mini B male cable.
3. Software application `ES000230.exe`, or later version, installed on the PC.

2.2 Handling Precautions

Like most evaluation kits, this product is designed for use in office and laboratory environments. The following practices will help ensure its proper operation.

2.2.1 Static Protection

This product uses low power CMOS circuits that can be damaged by electrostatic discharge. Partially damaged circuits can function erroneously, leading to misleading results. Observe ESD precautions at all times when handling this product.

2.2.2 Contents - Unpacking

Please ensure that you have received all of the items on the separate information sheet (EK0601) and notify CML within 7 working days if the delivery is incomplete.

2.3 Approvals

This product is not approved to any EMC or other regulatory standard. Users are advised to observe local statutory requirements, which may apply to this product.

3 Quick Start

This section is divided into two sub-sections. The first is for those users who are using the PE0601 with a PE0002 controller card and its Windows PC GUI software. The second is for users who are using the PE0601 by itself, without a PE0002.

3.1 With PE0002

Note that the C-BUS connector, J10, and the power connector J23 are both right angle headers and are designed to plug directly into sockets J5 (C-BUS 1 port) and J9 respectively, or sockets J3 (C-BUS 2 port) and J7 respectively, of a PE0002.

3.1.1 Setting-Up

- Refer to the PE0002 user manual and follow the instructions given in the quick start section.
- Ensure the jumpers JP1 and JP2 are open circuit. The BootEn1 and BootEn2 signals are driven from the PE0002.

The basic arrangement, when used with the PE0002, is shown below:

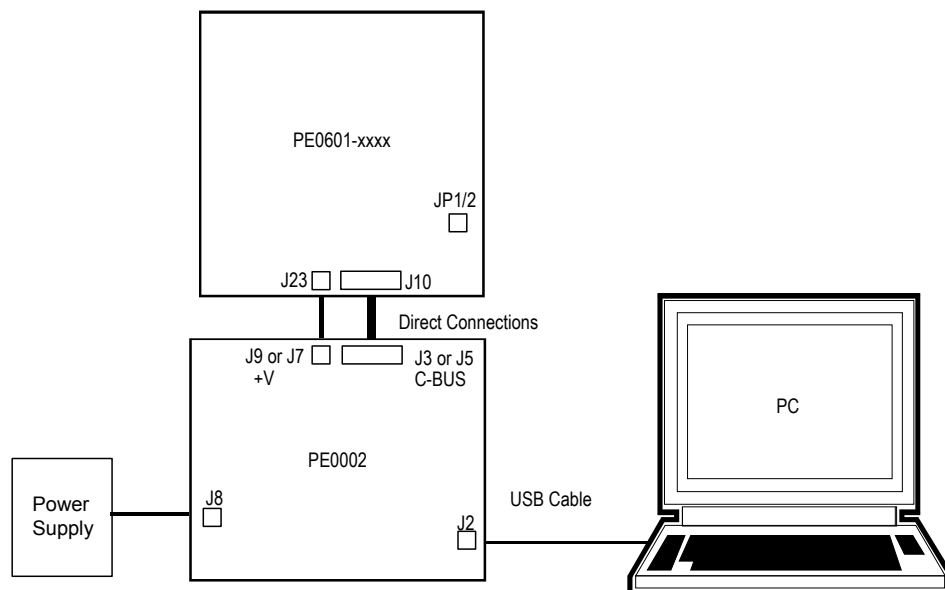

Figure 2 – PE0601 used with PE0002

3.1.2 Operation

The Function Image™ (FI) must now be loaded into the CMX7x6x device. A FI is provided as a 'C' type header file and must be obtained from the CML Technical Portal. There are two methods available for loading the FI:

1. Directly from a file on the PE0002 host PC to the CMX7x6x

2. From the on-board PE0601 serial memory. To use this method the serial memory must first be programmed with the FI by using the 'Program Serial Memory' tab on the PE0002 GUI software.

The PE0601 should now be ready for evaluation of the CMX7x6x with the chosen FI.

Please note that to access the CML Technical Portal you need to be authorised by a member of the CML sales staff. Please contact your local distributor, representative or area sales manager.

3.2 Without PE0002

As an alternative to using the PE0002 controller kit, users may control the CMX7x6x target device with a user-supplied host controller card. C-BUS connections are made via connector J10.

The power-up, or boot state of the CMX7x6x BOOTEN1 and BOOTEN2 pins may be set using jumpers JP1 and JP2. Consult the relevant CMX7x6x documentation for valid modes. A jumper in-circuit corresponds to a '0' state on the boot pins. Alternatively the state of these pins may be set via the connector, J10, pins 13 and 14. If jumpers JP1 and JP2 are left open circuit and the BOOTEN pins are not driven from connector J10, then by default, they are pulled high by the CMX7x6x device.

A FI for the CMX7x6x device must be either included in the customer's host system and loaded into the CMX7x6x device on power-up or programmed into the on-board serial memory following the guidelines in the application note: 'Writing a Function Image™ to Serial Memory'; available from the Application Notes area of the CML website.

4 Signal Lists

CONNECTOR PINOUT				
Connector Ref.	Connector Pin No.	Signal Name	Signal Type	Description
J1	TIP	IP1	I/P	Audio 1 input.
	RING	N/C	-	
	SLEEVE	GNDA	PWR	Analogue ground.
J2	TIP	IP2	I/P	Audio 2 input.
	RING	N/C	-	
	SLEEVE	GNDA	PWR	Analogue ground.
J3	TIP	SPKR1_P	O/P	Speaker 1 (8ohm) +ve.
	RING	N/C	-	
	SLEEVE	SPKR1_N	O/P	Speaker 1 (8ohm) -ve.
J4	TIP	SPKR2	O/P	Speaker 2 (32ohm).
	RING	N/C	-	
	SLEEVE	GNDA	PWR	Analogue ground.
J5	1	CLK EXT	I/P	External input option for CMX7x6x clock (not fitted).
J7	1	GPIO0/SSIN/F SI	BI	CMX7x6x signal, FI dependent.
	2	GPIO1/CLKI	BI	CMX7x6x signal, FI dependent.
	3	GPIO2/SSOU T2	BI	CMX7x6x signal, FI dependent.
	4	GPIO3/TXD	BI	CMX7x6x signal, FI dependent.
	5	GPIO4/RXD	BI	CMX7x6x signal, FI dependent.
	6	GPIO5/IRQN	BI	CMX7x6x signal, FI dependent.
	7	GPIO6/CSN	BI	CMX7x6x signal, FI dependent.
	8	GPIO7/CMD_ DATA	BI	CMX7x6x signal, FI dependent.
	9	GPIO8/REP_ DATA	BI	CMX7x6x signal, FI dependent.
	10	GPIO9/SCLK	BI	CMX7x6x signal, FI dependent.

CONNECTOR PINOUT				
Connector Ref.	Connector Pin No.	Signal Name	Signal Type	Description
J7	11	GPIO10/SYS CLK2	BI	CMX7x6x signal, FI dependent.
	12	GPIO11/SYS CLK1	BI	CMX7x6x signal, FI dependent.
	13	GPIO12/MOSI /SDO	BI	CMX7x6x signal, FI dependent.
	14	GPIO13/SSO UT1/FSO	BI	CMX7x6x signal, FI dependent.
	15	GPIO14/MISO /SDI	BI	CMX7x6x signal, FI dependent.
	16	GPIO15/SSO UT0	BI	CMX7x6x signal, FI dependent.
	17	CLK/CLKO	BI	CMX7x6x SSP clock signal, FI dependent.
	18	N/C	-	
	19, 20	GNDD	PWR	Digital ground.
J8	1	N/C	-	
	2	SPKR_2_OP	O/P	Speaker 2 (32ohm) output.
	3	GNDA	PWR	Analogue ground.
	4	GNDA	PWR	Analogue ground.
	5	SPKR_1_OP_ N	O/P	Speaker 1 (8ohm) -ve.
	6	SPKR_1_OP_ P	O/P	Speaker 1 (8ohm) +ve.
	7	SPKR_3V3	PWR	Dedicated 3.3 volt power rail for speaker 1 output.
	8	SPKR_1_VDD	PWR	DC supply for speaker 1.
	9	IP2	I/P	Audio input.
	10	IP1	I/P	Audio input.
J10	1	RESETN	I/P	CMX7x6x Reset control.
	2	CSN	I/P	Chip Select. Connects to host μ C.
	3	RFCSN	I/P	RF Serial Chip Select.
	4	CDATA	I/P	Serial data input. Connects to host μ C.
	5	RF_MOSI	I/P	RF serial data.

CONNECTOR PINOUT				
Connector Ref.	Connector Pin No.	Signal Name	Signal Type	Description
J10	6	SCLK	I/P	Serial clock input. Connects to host μ C.
	7	RF_SCLK	I/P	RF Serial Clock.
	8	RDATA	O/P	Serial data output. Connects to host μ C.
	10	IRQN	O/P	Interrupt request. Connects to host μ C.
	11, 12	GNDD	PWR	Digital ground.
	13	BOOTEN1	I/P	CMX7x6x hardware boot control.
	14	BOOTEN2	I/P	CMX7x6x hardware boot control.
	9, 15 to 20	N/C	-	
J11	1	SSOUT2	BI	C-BUS master, spare chip select, FI dependent.
	2	SSOUT1	BI	C-BUS master, chip select, FI dependent.
	3	GPIO6	BI	CMX7x6x signal, FI dependent.
	4	SDO	BI	C-BUS master, command data, FI dependent.
	5	GPIO7	BI	CMX7x6x signal, FI dependent.
	6	CLK	BI	C-BUS master, serial clock, FI dependent.
	7	GPIO8	BI	CMX7x6x signal, FI dependent.
	8	SDI	BI	C-BUS master, reply data, FI dependent.
	9	GPIO9	BI	CMX7x6x signal, FI dependent.
	10	GPIO11	BI	CMX7x6x signal, FI dependent.
	11, 12	GNDD	PWR	Digital ground.
	13	GPIO3	BI	CMX7x6x signal, FI dependent.
	14	GPIO4	BI	CMX7x6x signal, FI dependent.
	15	GPIO10	BI	CMX7x6x signal, FI dependent.
	17	SSOUT0	BI	C-BUS master, spare chip select, FI dependent.
16, 18, 19, 20	N/C	-		
J13	1	AUXADC3	I/P	Auxiliary ADC input.
	2	AUXDAC0	O/P	Auxiliary DAC output.
	3	AUXADC2	I/P	Auxiliary ADC input.
	4	AUXDAC1	O/P	Auxiliary DAC output.
	5	AUXADC1	I/P	Auxiliary ADC input.
	6	AUXDAC2	O/P	Auxiliary DAC output.

CONNECTOR PINOUT				
Connector Ref.	Connector Pin No.	Signal Name	Signal Type	Description
J13	7	AUXADC0	I/P	Auxiliary ADC input.
	8	AUXDAC3	O/P	Auxiliary DAC output.
	9, 10	GND A	PWR	Analogue ground.
J16	3	+V	PWR	External supply voltage, nominally +5 volt.
	2	0V	PWR	External supply ground.
	1	-V	PWR	Optional external negative supply voltage, nominally -5 volt.
J17	1	I_IN	I/P	I channel instrument input, single ended.
J18	1	Q_IN	I/P	Q channel instrument input, single ended.
J19	1	I_OUTP_I	I/P	I channel output positive, instrumentation input.
	2	I_OUTP	O/P	I channel output positive.
	3	I_OUTN_I	I/P	I channel output negative, instrumentation input.
	4	I_OUTN	O/P	I channel output negative.
	5, 6	GND A	PWR	Analogue ground.
	7	Q_OUTP_I	I/P	Q channel output positive, instrumentation input.
	8	Q_OUTP	O/P	Q channel output positive.
	9	Q_OUTN_I	I/P	Q channel output negative, instrumentation input.
	10	Q_OUTN	O/P	Q channel output negative.
	J20	1	I_OUT	O/P
J21	1	Q_OUT	O/P	Q channel instrumentation output, single ended.
J22	1	RF_MOSI	O/P	RF Serial Data.
	2	RF_SCLK	I/P	RF Serial Clock.
	3	GPIO12/MOSI /SDO	BI	CMX7x6x signal, FI dependent.
	4	GPIO14/MISO /SDI	BI	CMX7x6x signal, FI dependent.

CONNECTOR PINOUT				
Connector Ref.	Connector Pin No.	Signal Name	Signal Type	Description
J22	5	GNDD	PWR	Digital ground.
	6	GPIO13/SSO UT1/FSO	BI	CMX7x6x signal, FI dependent.
	7	GPIO2/SSOU T2	BI	CMX7x6x signal, FI dependent.
	8	GNDD	PWR	Digital ground.
	9	GPIO11/SYS CLK1	BI	CMX7x6x signal, FI dependent.
	10	GNDD	PWR	Digital ground.
	11	NC	-	
	12, 13	+V_RF	PWR	External supply voltage, nominally +5 volt.
	14	GNDA	PWR	Analogue ground.
	15	CLKEXT	I/P	External input option for CMX7x6x clock.
	16	AUXDAC0	O/P	Auxiliary DAC output.
	17	AUXDAC2	O/P	Auxiliary DAC output.
	18	GNDA	PWR	Analogue ground.
	19	AUXADC3	I/P	Auxiliary ADC input.
	20	AUXADC1	I/P	Auxiliary ADC input.
	21	GNDA	PWR	Analogue ground.
	22	IP1	I/P	Audio input.
	23	IP2	I/P	Audio input.
	24	SPKR_2_OP	O/P	Speaker 2 (32ohm).
	25	I_OUTP	O/P	I channel output positive.
	26	I_OUTN	O/P	I channel output negative.
	27, 28	NC	-	
	29	Q_OUTP	O/P	Q channel output positive.
	30	Q_OUTN	O/P	Q channel output negative.
	31	GNDA	PWR	Analogue ground.
	32	I_INP	I/P	I channel input positive.
	33	I_INN	I/P	I channel input negative.
	34, 35, 36, 37	GNDA	PWR	Analogue ground.
	38	Q_INP	I/P	Q channel input positive.
	39	Q_INN	I/P	Q channel input negative.

CONNECTOR PINOUT				
Connector Ref.	Connector Pin No.	Signal Name	Signal Type	Description
J22	40	GNDA	PWR	Analogue ground.
	41	AUXADC0	I/P	Auxiliary ADC input.
	42	AUXADC2	I/P	Auxiliary ADC input.
	43	GNDA	PWR	Analogue ground.
	44	AUXDAC3	O/P	Auxiliary DAC output.
	45	AUXDAC1	O/P	Auxiliary DAC output.
	46, 47, 48	GNDA	PWR	Analogue ground.
	49	+V	PWR	External supply voltage, nominally +5 volt.
	50	NC	-	
	51	GNDD	PWR	Digital ground.
	52	GPIO10/SYS CLK2	BI	CMX7x6x signal, FI dependent.
	53	GNDD	PWR	Digital ground.
	54	GPIO4/RXD	BI	CMX7x6x signal, FI dependent.
	55	GPIO0/SSIN/F SI	BI	CMX7x6x signal, FI dependent.
	56	GNDD	PWR	Digital ground.
	57	GPIO5/IRQN	BI	CMX7x6x signal, FI dependent.
	58	CLK/CLKO	BI	CMX7x6x SSP clock signal, FI dependent.
	59	RFCSN	O/P	RF Serial Chip Select.
	60	GPIO1/CLKI	BI	CMX7x6x signal, FI dependent.
	J23	1, 2	GNDD	PWR
3 to 6		+V	PWR	External supply voltage – daisy-chained from PE0002.
J24	1	I_INP_I	O/P	I channel input positive, instrumentation output.
	2	I_INP	I/P	I channel input positive.
	3	I_INN_I	O/P	I channel input negative, instrumentation output.
	4	I_INN	I/P	I channel input negative.
	5, 6	GNDA	PWR	Analogue ground.
	7	Q_INP_I	O/P	Q channel input positive, instrumentation output.
	8	Q_INP	I/P	Q channel input positive.

CONNECTOR PINOUT				
Connector Ref.	Connector Pin No.	Signal Name	Signal Type	Description
J24	9	Q_INN_I	O/P	Q channel input negative, instrumentation output.
	10	Q_INN	I/P	Q channel negative positive.

Table 1 – Signal List

Notes:	BI	=	Bidirectional
	HiZ	=	High impedance
	I/P	=	Input
	N/C	=	Not connected
	O/P	=	Output
	PWR	=	Power supply connection

TEST POINTS		
Test Point Ref.	Default Measurement	Description
TP1	-	Loop – IP1 - Audio 1 inverting input.
TP2	-	Loop – IP2 - Audio 2 inverting input.
TP3	3.3V	Pad – CMX7x6x V _{BIAS} .
TP4	CMX7x6x dependent	Loop – CMX7x6x GPIO11/SYSCLK1 - FI dependent.
TP5	CMX7x6x dependent	Loop – CMX7x6x GPIO10/SYSCLK2 - FI dependent.
TP6	HiZ	Loop – Speaker 1 (8ohm) –ve output.
TP7	HiZ	Loop – Speaker 1 (8ohm) +ve output.
TP8	HiZ	Loop – Speaker 2 (32ohm) output.
TP9	0V	Loop – GNDD, digital ground.
TP10	0V	Loop – GNDD, digital ground.
TP11	0V	Loop – GNDA, analogue ground.
TP12	0V	Loop – GNDA, analogue ground.
TP13	-	Pad – Optional external negative supply voltage, nominally -5 volt.
TP14	+5V	Pad – External supply voltage.
TP15	+3.3V	Pad – Output from on-board regulator. DC supply voltage for analogue rail.
TP16	+3.3V	Pad – Output from on-board regulator. DC supply voltage for digital rail.
TP17	+3.3V	Pad – Output from on-board regulator. Dedicated DC supply voltage for speaker 1 driver.
TP18	-4.0V	Pad – Output from on-board regulator. Negative supply voltage for instrumentation interface, -4.0V – if required.
TP19	+1.8V	Pad – Output from on-board regulator. Optional external DC supply voltage for CMX7x6x core.
TP20	+1.8V	Pad – CMX7x6x internally generated core voltage.
TP21	+4.0V	Pad – Output from on-board regulator. Positive supply voltage for instrumentation interface, +4.0V – if required.
TP22	-	Spare operational amplifier circuit input.
TP23	-	Spare operational amplifier circuit input.
TP24	0V	Spare operational amplifier circuit output.
TP25	0V	Spare operational amplifier circuit output.
TP26	-	Spare operational amplifier circuit input.
TP27	-	Spare operational amplifier circuit input.

Table 2 – Test Points

JUMPERS			
Link Ref.	Positions	Default Position	Description
JP1	1-2	Open	Manual BootEn1 control (short = LO).
JP2	1-2	Open	Manual BootEn2 control (short = LO).
JP8	1-2	Open	Allow CMX7x6x GPIO3/4 to drive LEDs D2/3.
JP11	1-2	Short	Isolates analogue supply rail from CMX7x6x.
JP13	1-2	Short	Isolates digital supply rail from CMX7x6x.
JP14	1-2	Open	Isolates external +1.8 volt supply rail from CMX7x6x.
J6	1-2	Short	19.2MHz oscillator clock source.
	3-4	Open	External clock source.
	5-6	Open	Crystal clock source – if components fitted by customer.
	7-8	Short	Ground external clock input.
	9-10	Open	Crystal clock source – if components fitted by customer.
J8	7-8	Short	Isolates +3.3 volt supply of speaker 1 driver.
J14	1-2	Open	Isolates GPIO2/SSOUT2 from C-BUS master on J11.
	3-4	Open	Isolates GPIO6 from C-BUS master on J11.
	5-6	Open	Isolates GPIO7 from C-BUS master on J11.
	7-8	Open	Isolates GPIO8 from C-BUS master on J11.
	9-10	Open	Isolates GPIO11 from C-BUS master on J11.
	11-12	Open	Isolates GPIO9 from C-BUS master on J11.
	13-14	Open	Isolates GPIO4 from C-BUS master on J11.
	15-16	Open	Isolates GPIO3 from C-BUS master on J11.
	17-18	Open	Isolates GPIO10 from C-BUS master on J11.
19-20	Open	Isolates GPIO15/SSOUT0 from C-BUS master on J11.	
J19	1-2	Open	Isolates I channel output +ve from instrumentation interface.
	3-4	Open	Isolates I channel output -ve from instrumentation interface.
	7-8	Open	Isolates Q channel output +ve from instrumentation interface.
	9-10	Open	Isolates Q channel output -ve from instrumentation interface.

JUMPERS			
Link Ref.	Positions	Default Position	Description
J24	1-2	Open	Isolates I channel input +ve from instrumentation interface.
	3-4	Open	Isolates I channel input -ve from instrumentation interface.
	7-8	Open	Isolates Q channel input +ve from instrumentation interface.
	9-10	Open	Isolates Q channel input -ve from instrumentation interface.

Table 3 – Jumpers

LEDs	
LED Ref.	Description
D2	Indicates state of GPIO3 if JP8 fitted.
D3	Indicates state of GPIO4 if JP8 fitted.
D6	Indicates that the digital supply voltage is present.

Table 4 – LEDs

5 Circuit Schematics and Board Layouts

For clarity, circuit schematics are available as separate high-resolution files. These can be obtained via the CML website.

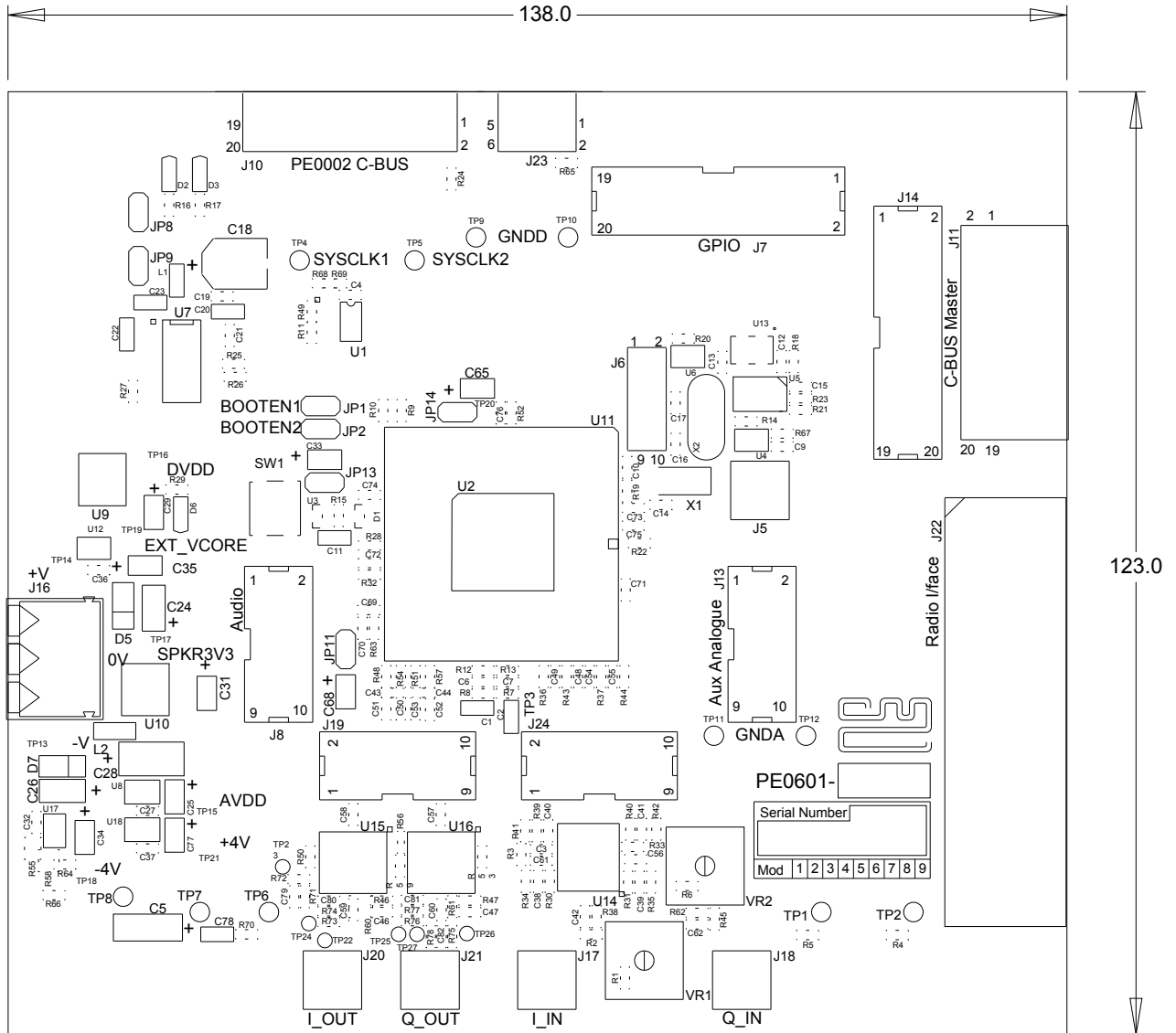

Figure 3 – PCB Layout: Top

6 Detailed Description

6.1 Hardware Description

The PE0601 as shipped may not have the optimum configuration or component values for all function images. Check the PE0601 schematic against recommendations in the specific CMX7x6x datasheet.

6.1.1 Power Supplies

The board is fitted with six voltage regulators.

U8 and U9 provide the analogue and digital supply rails respectively. U10 provides a separate supply rail for the CMX7x6x speaker driver and U12 provides an external 1.8 volt supply option for the CMX7x6x core. The input to these four regulators should be provided by an external 5V dc regulated power supply, which can be daisy chained from the PE0002 or connected to the board via connector J16, a push type connector. LED illumination confirms the on-board presence of the +3.3V dc digital voltage supply.

U17 provides a negative supply rail for the instrumentation interface. If required, an additional –5V dc regulated supply should be connected at J16. U18 provides a positive supply rail for the instrumentation interface.

Each supply has a test point where it can be monitored; see Table 2 – Test Points.

6.1.2 Clock Options

The PCB is designed to provide three CMX7x6x device clock options. The board is supplied with a 19.2MHz oscillator module fitted.

Other options are an external clock source at J5 (not fitted) or a quartz crystal oscillator circuit at C16, C17 and X2 (not fitted).

Header J6 is used with jumper sockets to select the required option as shown in the table below. Shaded cells illustrate locations where a jumper socket should be fitted.

J4 Jumper Position	Clock Option		
	19.2MHz oscillator (default)	External	Quartz crystal
1-2			
3-4			
5-6			
7-8			
9-10			

Table 5 – Clock Select Jumper Positions

As an alternative to the 19.2MHz oscillator a more accurate TCXO could be used with the following component changes:

Reference Designator	Action	Description
U13	Remove	-
C15	Fit	100nF 0603
R21	Fit	18kohm 0603
R22	Fit ^[1]	0R 0603
R23	Fit	15kohm 0603
U5	Fit	Golledge GTXO-83 series TCXO, or similar

Table 6 – TCXO Component Changes

Note^[1], if required allows adjustment from CMX7x6x AuxDAC3 – if supported by the FI being evaluated.

Additionally, a 32,768Hz crystal is fitted to the CMX7x6x low power oscillator.

6.1.3 Control Interface

The C-BUS and CMX7x6x boot control signals are brought out on connector J10. This is a right angle male header designed to plug directly into the PE0002 interface card's matching female header.

Alternatively, if not using the PE0002, the CMX7x6x boot control signals can be manually set with jumpers JP1 and JP2.

6.1.4 Serial Memory

The serial memory, U1, can be used for non-volatile storage of a Function Image™. The PE0601 is shipped with a blank serial memory.

The chip select signal for the serial memory is provided by the SSOUT0 signal from the CMX7x6x device. If the serial memory is not required, this signal, or the GPIO15 option of the same pin, can be used for another purpose by moving the 0 ohm link from position R69 to position R68. The signal GPIO15/SSOUT0 is then available at connector J7, and also J11 if a jumper is inserted across J14 pin 19 and 20.

6.1.5 Baseband Interfacing

The availability and usage of these signals are Function Image™ dependent.

The CMX7x6x differential I and Q inputs are fed through a RC network. Specific requirements for this network are FI dependent. Differential signals can be input to the RC networks at header, J24. CML evaluation kits for RF receiver products have matching headers, but the I or Q signal polarity must be observed. Alternatively, check Function Image™ documentation for the possibility of a programmable signal inversion.

The CMX7x6x differential I and Q outputs are fed through a RC network. Specific requirements for this network are FI dependent. The differential signals output from the RC networks can be monitored at header, J19. CML evaluation kits for RF transmitter products have matching headers, but the I or Q signal polarity must be observed. Alternatively, check Function Image™ documentation for the possibility of a programmable signal inversion.

The CMX7x6x device audio input amplifiers for IP1 and IP2 are configured as ac coupled, unity gain, inverting amplifiers. The inputs to these circuits are fed from connectors J1 and J2 respectively.

The CMX7x6x device speaker outputs, SPKR1 and SPKR2, are fed to connectors J3 and J4 respectively. The SPKR1 output can drive an 8ohm speaker and requires that the driver supply, SPKR_3V3, be connected via jumpers in-circuit between pins 3, 4 and 7, 8 of header J8.

Connector J13 provides access to auxiliary ADCs 1 to 4 and auxiliary DACs 1 to 4 of the CMX7x6x device.

6.1.6 RF Transceiver Interface

The RF Transceiver interface, J22, is a 60-way right-angled connector with all of the following signals:

- Serial interface (from J10 – separate from C-BUS interface)
- CMX7x6x GPIO
- 5V and -5V Power (direct from PCB input supply - unregulated). May be isolated by removing R65 and R66 respectively.
- Clock input (external clock option for CMX7x6x, selected at J6). R67 must be fitted with a 0ohm link to use this option.
- I and Q differential inputs and outputs
- Audio inputs 1 and 2 and speaker 2 output (32ohm)
- All auxiliary ADCs and DACs
- Digital and analogue grounds

The connector is made by JAE and is part number TX24-60R-LT-H1E. The mating half is part number TX25-60P-LT-XXX. Both parts are available in the UK from Digi-Key.

6.1.7 Instrumentation Interface

An instrumentation interface has been provided to enable connection of the differential I and Q signals to laboratory equipment that has only single-ended connections. Use of this section of the PE0601 requires an additional negative supply rail, nominally –5 volts.

The input path has an effective gain of 6dB.

The input path is configured for, nominally, 0 volts offset in the differential signal input to the CMX7x6x. This can be made adjustable by removing resistors R1 and R6 and replacing them with 50kohm potentiometers in positions VR1 and VR2 for the I and Q input paths respectively. Bourns type 3386P or similar will fit the footprints provided.

There are also two spare op-amps in this section that are configured as unity-gain buffers with the input tied to analogue ground. Further component footprints are provided so that these can be reconfigured and test pads are provided for input and output.

6.1.8 Digital Interfacing

Connector J7 provides access to all general purpose I/O lines and to a synchronous serial port. Use of these signals is Function Image™ dependent. In some cases they will have no function. See relevant CMX7x6x documentation.

Connector J11 is configured as a C-BUS master and compatible with CML evaluation kits with C-BUS slave connectors. Two more chip selects and other GPIO signals can be routed to this connector with jumpers at header, J14. Use of this feature is also Function Image™ dependent.

6.2 Adjustments and Controls

The boot state of the CMX7x60 device can be set manually, using jumpers JP1 and JP2. If using with the PE0002, the jumpers should be left open circuit.

6.3 Function Image™

There are two methods by which a FI may be loaded into the CMX7x6x device.

Whenever power is removed from the PE0601 the FI data will be erased from the CMX7x6x device. Therefore, whenever power is applied a FI must be loaded, either from the serial memory or via the C-BUS interface.

If the PE0601 is used with the PE0002 evkit interface card, function images can be loaded as described in sections 6.3.1, 6.3.2 and 6.3.3.

6.3.1 Load Function Image™ via C-BUS

Use the 'Function Image™ Load' tab. Select Function Image™ Source: 'C-BUS'.

- Enter the name of the file containing the Function Image™, or navigate to the required file using the 'Browse' button.
- Select target board.
- Click the 'Load' button. The progress of the download is shown visually on the progress bar and when the download has completed a message box will be displayed indicating if the result of the download operation was successful or not.

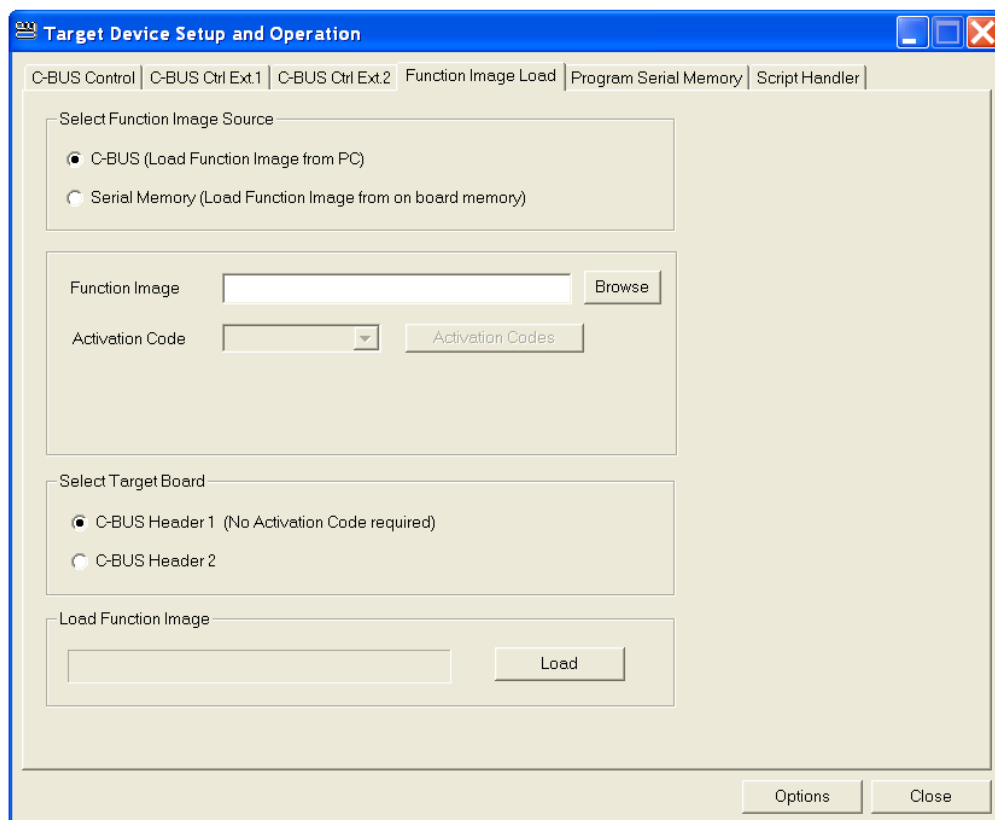

Figure 5 – Function Image™ Load Tab – via C-BUS

6.3.2 Load Function Image™ from Serial Memory Device

It is assumed that the serial memory has been programmed with the Function Image™ prior to using this load method. This can be carried out with the serial memory in circuit using the ES0002xx 'Program Serial Memory' tab.

Use the 'Function Image™ Load' tab. Select Function Image™ Source: 'Serial Memory'.

- Select target board.
- Click the 'Load' button. The progress of the download is shown visually on the progress bar and when the download has completed a message box will be displayed indicating if the result of the download operation was successful or not.

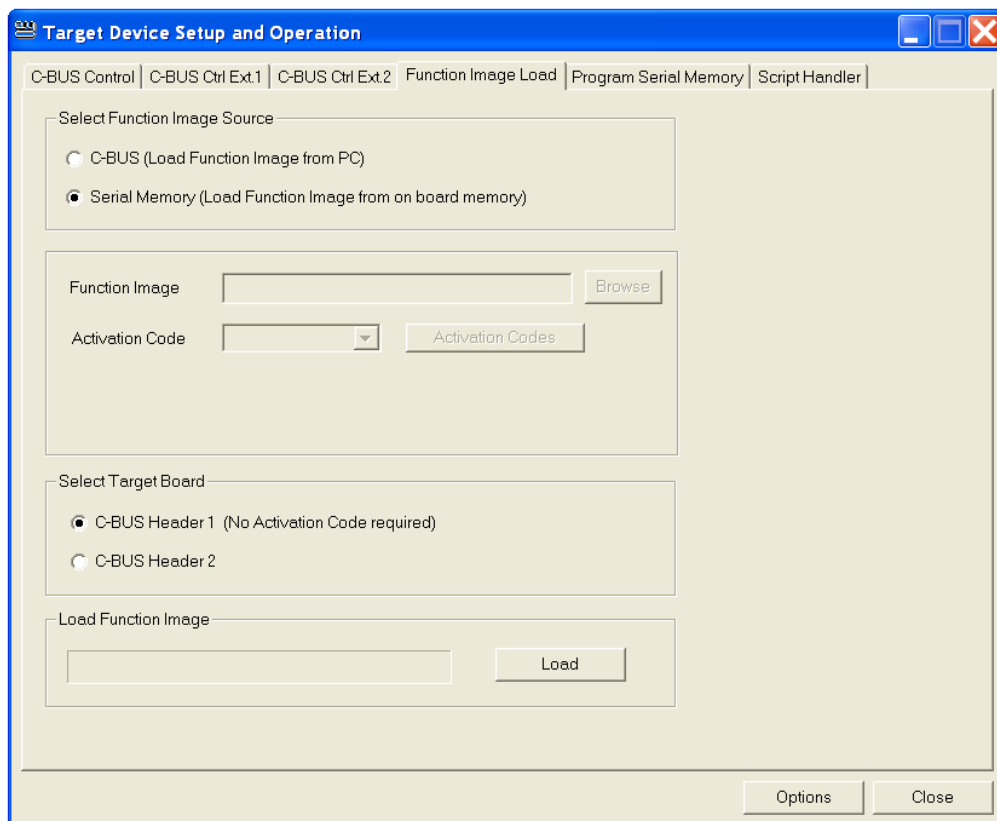

Figure 6 – Function Image™ Load Tab – from Serial Memory

6.3.3 Program Serial Memory

The serial memory device fitted to the PE0601 is a Numonyx or ST M25P10A 1Mbit SPI serial Flash or equivalent. Loading a FI into this serial memory requires a "thick stub" application programme **EF0601_M25P10_10_XXXX.h** (or later version), where 'xxxx' is the 'xxxx' element of PE0601-xxxx. For example, if using a PE0601-7163, then the thick stub programme to use is **EF0601_M25P10_10_7163.h**. The thick stub programme is available from the CML website.

Use the 'Program Serial Memory' tab:

- Enter the name of the file containing the thick stub (**EF0601_M25P10_10_XXXX.h**), or navigate to the required file using the 'Browse' button. This file is in the same 'C' language header format as the Function Image™.
- Enter the name of the file containing the Function Image™, or navigate to the required file using the 'Browse' button.
- Select target board.
- Click the 'Load' button.

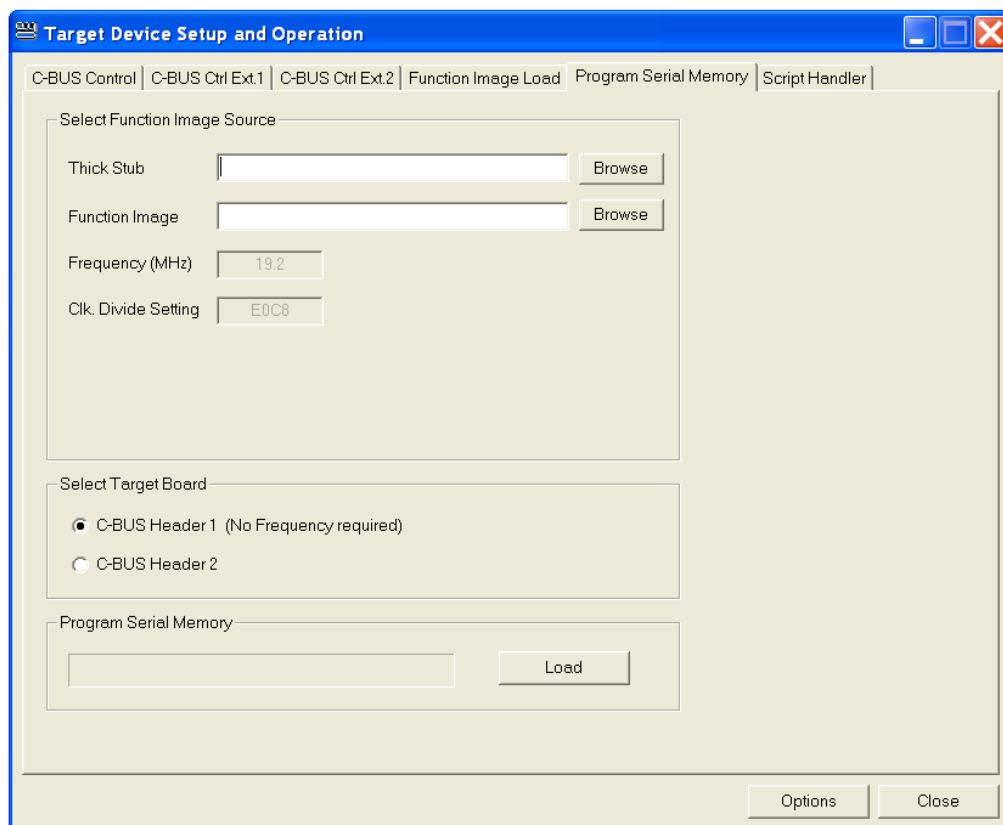

Figure 7 – Program Serial Memory Tab

Shortly after pressing the 'Load' button, a message box will confirm that the application has loaded the Thick Stub.

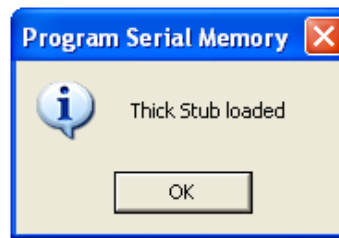

Figure 8 – Thick Stub Loaded Message Box

Click on the message box 'OK' button and the application will proceed to programme the Function Image™ into the serial memory on the PE0601 card. Progress is shown visually on the progress bar. When programming is complete a message box will be displayed indicating if the operation was successful or not.

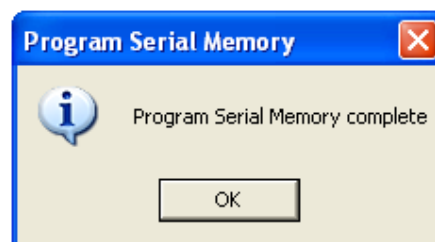

Figure 9 – Program Serial Memory Complete Message Box

6.4 Troubleshooting

7 Performance Specification

7.1 Electrical Performance

7.1.1 Absolute Maximum Ratings

Exceeding these maximum ratings can result in damage to the evaluation kit.

	Min.	Max.	Units
Supply (+V – 0V)	-0.3	9.0	V
Supply (-V – 0V)	0.3	-9.0	V
Voltage on any connector pin to V _{SS}	-0.3	3.6	V
Current into or out of +V and V _{SS} pins	0	+0.45	A
Current into or out of any other connector pin	-20	+20	mA

7.1.2 Operating Limits

Correct operation of the Evaluation Kit outside these limits is not implied.

	Notes	Min.	Max.	Units
Supply (+V – 0V)		4.5	5.5	V
Supply (-V – 0V)		-4.5	-5.5	V
External Clock Frequency		3.0	24.576	MHz

7.1.3 Operating Characteristics

For the following conditions unless otherwise specified:

Evaluation device clock frequency = 19.2MHz, +V = 5.0V, Tamb = +25°C.

For CMX7x6x parameters, see relevant CMX7x6x datasheet.

	Notes	Min.	Typ.	Max.	Units
DC Parameters					
I _{DD}	1, 2	-	60	-	mA
-I _{DD}	1, 2	-	-30	-	mA
+3V3A		3.15	3.3	3.45	V
+3V3D		3.15	3.3	3.45	V
+3V3SPKR		3.15	3.3	3.45	V
+1V8_CORE		1.70	1.8	1.85	V
+4V0		3.82	4.0	4.18	V
-4V0		-3.82	-4.0	-4.18	V
Analogue Parameters					
Output Impedances					
I/Q_OUTP/N	3	-	22	-	kΩ
Speaker 1	4				
Speaker 2	4				
Input Impedances					
IP1 and IP2		-	50	-	kΩ
I/Q_INP/N	4				
I/Q_IN		-	5	-	kΩ
External Clock Input					
'High' Pulse Width		21	-	-	ns
'Low' Pulse Width		21	-	-	ns
Input Impedance		10	-	-	MΩ

Notes:

1. PCB current consumption. Not the current consumption of the CMX7x6x.
2. Not including any current drawn from pins by external circuitry.
3. Small signal impedance.
4. CMX7x6x parameter, see relevant CMX7x6x datasheet.

7.1.4 Operating Characteristics - Timing Diagrams

Please refer to relevant CMX7x6x datasheet for details.



About FirmASIC®

CML's proprietary FirmASIC® component technology reduces cost, time to market and development risk, with increased flexibility for the designer and end application. FirmASIC® combines Analogue, Digital, Firmware and Memory technologies in a single silicon platform that can be focused to deliver the right feature mix, performance and price for a target application family. Specific functions of a FirmASIC® device are determined by uploading its Function Image™ during device initialization. New function images may be later provided to supplement and enhance device functions, expanding or modifying end-product features without the need for expensive and time-consuming design changes. FirmASIC® devices provide significant time to market and commercial benefits over Custom ASIC, Structured ASIC, FPGA and DSP solutions. They may also be exclusively customised where security or intellectual property issues prevent the use of Application Specific Standard Products (ASSP's).

CML does not assume any responsibility for the use of any circuitry described. No IPR or circuit patent licences are implied. CML reserves the right at any time without notice to change the said circuitry and any part of this product specification. Evaluation kits and demonstration boards are supplied for the sole purpose of demonstrating the operation of CML products and are supplied without warranty. They are intended for use in a laboratory environment only and are not for re-sale, end-use or incorporation into other equipments. Operation of these kits and boards outside a laboratory environment is not permitted within the European Community. All software/firmware is supplied "as is" and is without warranty. It forms part of the product supplied and is licensed for use only with this product, for the purpose of demonstrating the operation of CML products. Whilst all reasonable efforts are made to ensure that software/firmware contained in this product is virus free, CML accepts no responsibility whatsoever for any contamination which results from using this product and the onus for checking that the software/firmware is virus free is placed on the purchaser of this evaluation kit or development board.

 CML Microcircuits (UK) Ltd <small>COMMUNICATION SEMICONDUCTORS</small>	 CML Microcircuits (USA) Inc. <small>COMMUNICATION SEMICONDUCTORS</small>	 CML Microcircuits (Singapore) Pte Ltd <small>COMMUNICATION SEMICONDUCTORS</small>
Tel: +44 (0)1621 875500 Fax: +44 (0)1621 875600 Sales: sales@cmlmicro.com Tech Support: techsupport@cmlmicro.com	Tel: +1 336 744 5050 800 638 5577 Fax: +1 336 744 5054 Sales: us.sales@cmlmicro.com Tech Support: us.techsupport@cmlmicro.com	Tel: +65 62 888129 Fax: +65 62 888230 Sales: sg.sales@cmlmicro.com Tech Support: sg.techsupport@cmlmicro.com
- www.cmlmicro.com -		

X-ON Electronics

Largest Supplier of Electrical and Electronic Components

Click to view similar products for [Interface Development Tools](#) category:

Click to view products by [CML Microcircuits](#) manufacturer:

Other Similar products are found below :

[DP130SSEVM](#) [ISO3086TEVM-436](#) [ADP5585CP-EVALZ](#) [CHA2066-99F](#) [AS8650-DB](#) [I2C-CPEV/NOPB](#) [ISO35TEVM-434](#)
[XR18910ILEVB](#) [XR21B1421IL28-0A-EVB](#) [EVAL-ADM2491EEBZ](#) [MAXREFDES23DB#](#) [MAX9286COAXEVKIT#](#) [MAX3100EVKIT](#)
[MAX13235EEVKIT](#) [MAX14970EVKIT#](#) [XR21B1424IV64-0A-EVB](#) [CMOD232+](#) [MAX13042EEVKIT+](#) [MAX14838EVKIT#](#)
[MAXCAM705OV635AAA#](#) [MAX9205EVKIT](#) [DS100BR111AEVK/NOPB](#) [DC241C](#) [MAX9286RCARH3DB#](#) [MAX13035EEVKIT+](#)
[DC1794A](#) [SN65HVS885EVM](#) [EVB81112-A1](#) [DFR0257](#) [ZLR964122L](#) [ZLR88822L](#) [DC196A-B](#) [DC196A-A](#) [DC327A](#) [OM13585UL](#)
[MAX16972AGEEVKIT#](#) [MARS1-DEMO3-ADAPTER-GEVB](#) [PIM511](#) [PIM536](#) [PIM517](#) [DEV-17512](#) [STR-FUSB3307MPX-PPS-GEVK](#)
[MAXREFDES177#](#) [EVAL-ADN4654EBZ](#) [MAX9275COAXEVKIT#](#) [MAX2202XEVKIT#](#) [MAX13171EEVKIT+](#) [MAX7322EVKIT+](#)
[MAX9281COAXEVKIT#](#) [MAX96715COAXEVKIT#](#)