

MECHANICAL DIMENSION

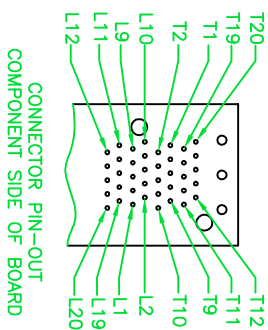
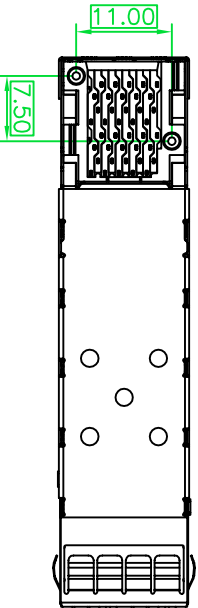
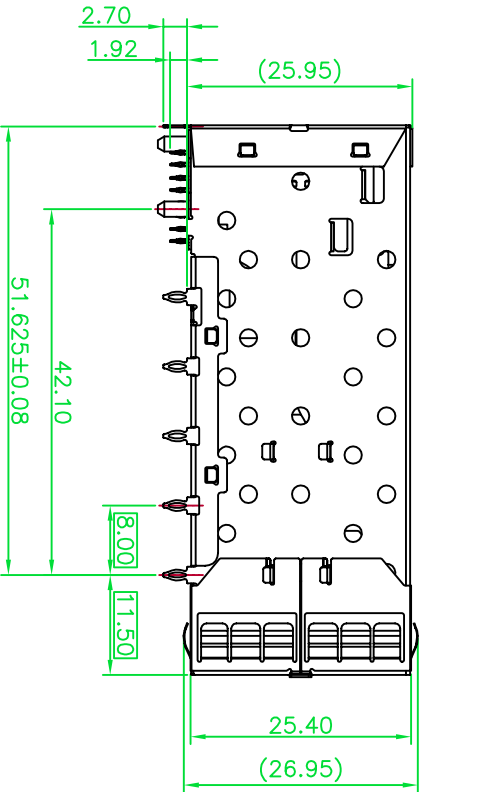
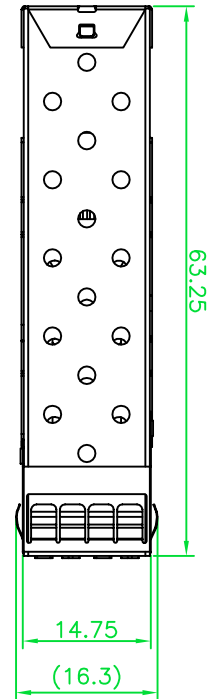

CONNECTOR PIN-OUT COMPONENT SIDE OF BOARD

NOTES:

MATERIAL:
CAGE: NICKEL SILVER

CONNECTOR:
PLASTIC HOUSING: HIGH TEMPERATURE LCP, UL94 V-0.
LIGHT PIPE: POLYCARBONATE; COLOR: CLEAR
SPRING: STAINLESS STEEL
CONTACTS: PHOSPHOR BRONZE
CONTACT PLATING: 15u" MIN. GOLD ON MATING AREA,
150u" MATTE TIN ON SOLDER TAILS

PACKAGING: TRAY PACKAGING.

TEMPERATURE RANGE: -40°C TO +85°C

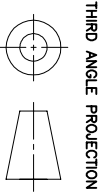

THIRD ANGLE PROJECTION

CND-TEK
深圳 矽联达 电子有限公司
Shen zhen cnd-tek Electronics Co., Ltd
Web: <http://www.cd-tek.com>

DO NOT SCALE DRAWING
DRAWING IS SUBJECT TO
CHANGE WITHOUT NOTICE
DIMENSIONS: mm(INCH)

TITLE
SFP+ 2X1 COMBO WITH GROUNDING PIN

PART NO.
AE90K1104000

.XX±0.15
SHEET NO.
1 OF 3

Product: PCB JACK RJ45 RJ11 USB
CONNECTOR SFP CONNECTOR TRANSFORMER

DRN BY: TONY	DATE: 12-10-08
APPD BY: JIM	DATE: 9-23-09
DWG NO: SFP20005	REV: A10

B

A

DATE	REV	ECN	APP'D.

B

A



RoHS

MECHANICAL DIMENSION

DATE	REV	ECN	APP'D.

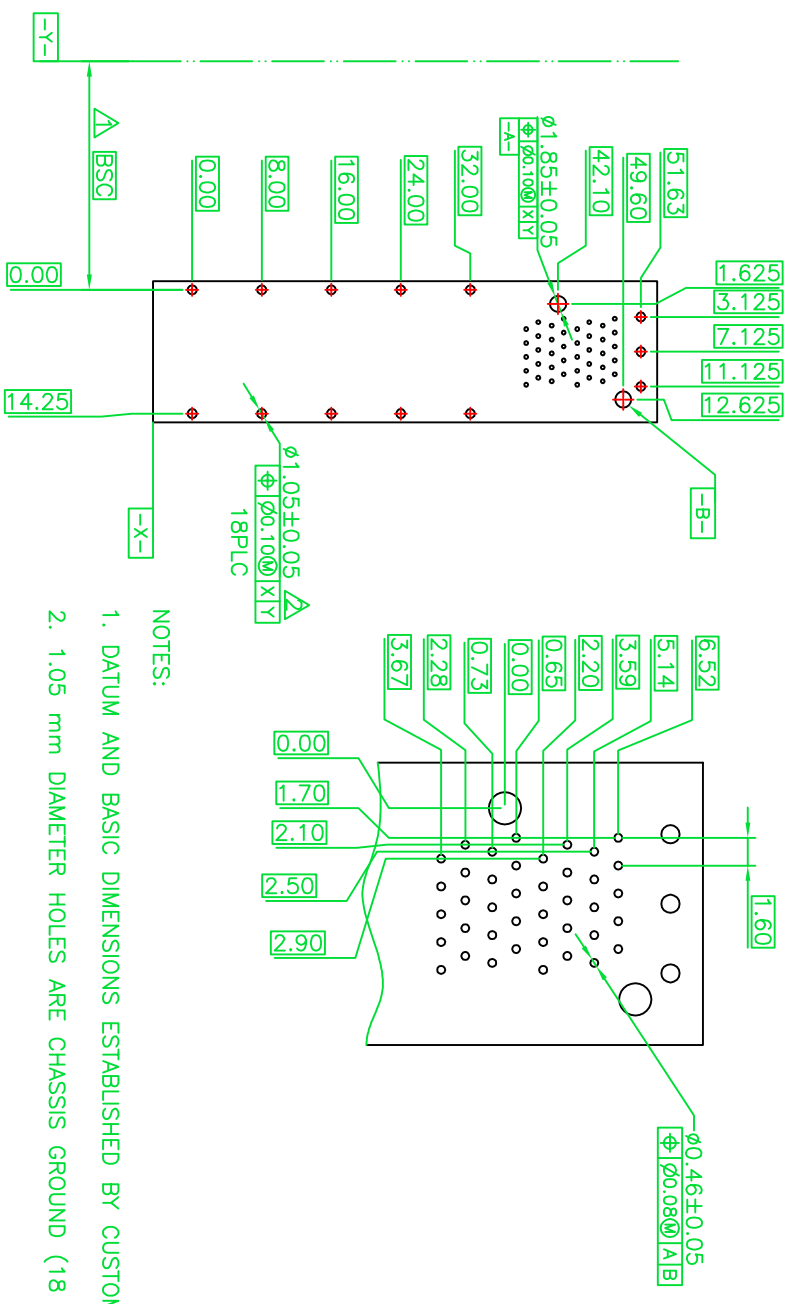

- NOTES:
1. DATUM AND BASIC DIMENSIONS ESTABLISHED BY CUSTOMER.
 2. 1.05 mm DIAMETER HOLES ARE CHASSIS GROUND (18 HOLES).

ECOMMENDED PCB CONFIGURATION

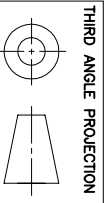

THIRD ANGLE PROJECTION

CND-TEK

深圳磁联达电子有限公司
Shen zhen cnd-tek Electronics Co., Ltd
Web: <http://www.cd-tek.com>

DO NOT SCALE DRAWING	TITLE	DRW BY:	DATE:
DRAWING IS SUBJECT TO CHANGE WITHOUT NOTICE	SFP+ 2X1 COMBO WITH GROUNDING PIN	TONY	12-10-08
DIMENSIONS: mm(INCH)	PART NO:	APP'D BY:	DATE:
.XX±0.15 .XXX±0.10	AE90K1104000	JIM	9-23-09
SHEET NO. 2 OF 3	Product: PCB JACK RJ45 RJ11 USB CONNECTOR SFP CONNECTOR TRANSFORMER	DWG NO: SFP20005	REV: A10



MECHANICAL DIMENSION

DATE	REV	ECN	APP'D.

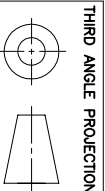
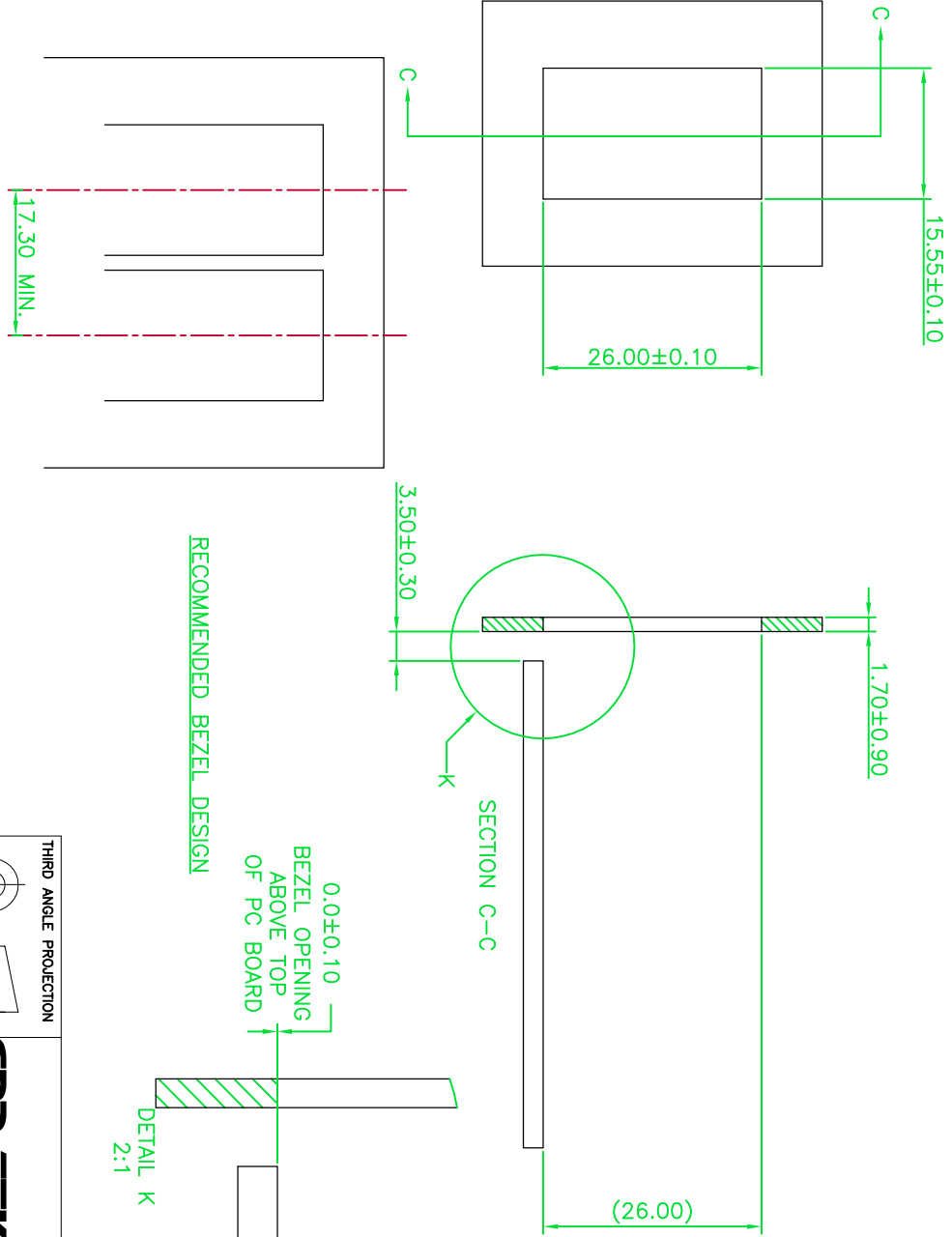

DO NOT SCALE DRAWING
DRAWING IS SUBJECT TO CHANGE WITHOUT NOTICE
DIMENSIONS: mm(INCH)

.X±0.20	.XXX±0.10
.XX±0.15	
SHEET NO.	3 OF 3

CND-TEK
 深圳磁联达电子有限公司
 Shen zhen cnd-tek Electronics Co., Ltd
 Web: <http://www.cd-tek.com>

TITLE
SFP+ 2X1 COMBO WITH GROUNDING PIN

PART NO.
AE90K1104000

Product: PCB JACK RJ45 RJ11 USB
CONNECTOR SFP CONNECTOR TRANSFORMER

DRW BY: TONY	DATE: 12-10-08
APP'D BY: JIM	DATE: 9-23-09
DWG NO: SFP20005	REV: A10



X-ON Electronics

Largest Supplier of Electrical and Electronic Components

Click to view similar products for [Modular Connectors](#) / [Ethernet Connectors](#) category:

Click to view products by [CND-tek](#) manufacturer:

Other Similar products are found below :

[8949-H88/06BLKA/SN](#) [74441-0010/BKN](#) [PHP-6P6C-5](#) [GAX-3-66](#) [GDCX-PN-66](#) [GLX-A-44](#) [GLX-N-1010M-BLK](#) [GLX-S-88M-BLK](#)
[GMX-SMT4-N-88](#) [GSGX-N-2-88](#) [GSGX-N-4-88](#) [GSX-NS2-88-3.05](#) [GSX-NS-88-3.68](#) [PT-108A-8C-UL](#) [PTS-J531-8CS-50UL](#) [A-2014-0-4](#)
[GWLX-S9-88-YG](#) [DC-1021-8-WH-6](#) [1300530003](#) [1324640-4](#) [132764-001](#) [1413235](#) [MPS88RX-5000](#) [E5288-S000K3-L](#) [155302-001](#)
[AX101050](#) [AX101063](#) [AX101065](#) [AX101072](#) [AX101307](#) [AX101315](#) [AX101318](#) [AX102271](#) [AX102277](#) [AX102651](#) [AX102660](#) [AX104024](#)
[203475](#) [PC4D0018P](#) [KIT38082NI](#) [8949-B88/6](#) [2-6609208-5](#) [30-8956](#) [30-8964-100](#) [SM85](#) [SM99S01VBNN04G7](#) [17-103540](#) [191587](#) [PDI-68-RV](#) [PHP-8P8C-S-5](#)