



SMD PULSE TRANSFORMER

High Common Mode Impedance at High Frequency.
Excellent Noise Suppression Performance.
Small Size and Low Profile, Surface Mount Type.
Operating Temperature Range: -40 °C to +85 °C.
RoHS Compliant.

Part Number	Electrical Specifications @25°C				
	Common mode Impedance (ohm ±25%@100M)	DCR (Ω Max)	Rated Current mA Max	Rated Volt (Vdc)	IR M(Ω Min)
CC2012E-801	800	0.88	300	50	10

MECHANICAL

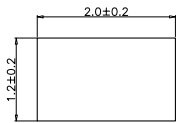

TOP VIEW

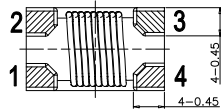

BOTTOM VIEW

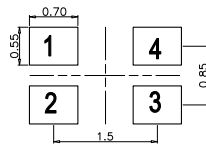

SUGGEST LAYOUT

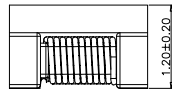

SIDE VIEW

SCHEMATICS

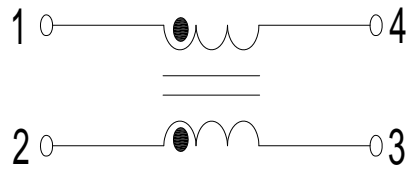

Unless otherwise specified all tolerances are:±0.25mm

TAPING AND PACKING

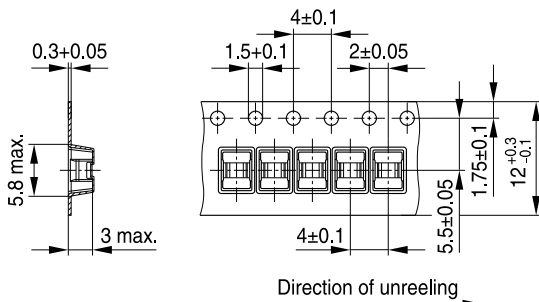

IND1752-J-E

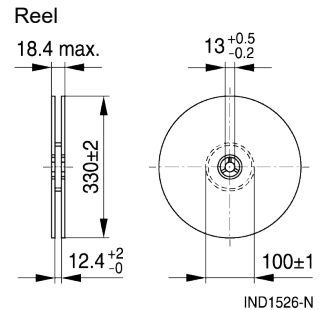

Dimensions in mm

Quantity (pcs):
3000 PCS PER REEL
30 REELS PER CARTON
90000 PCS PER CARTON

X-ON Electronics

Largest Supplier of Electrical and Electronic Components

Click to view similar products for [Common Mode Chokes / Filters](#) category:

Click to view products by [CND-tek](#) manufacturer:

Other Similar products are found below :

[PE-64683](#) [RD5122-6-9M6](#) [RD6137-6-7M5](#) [RD8147-16-3M0](#) [ST6118T-R](#) [FE3X025-10-7NL](#) [RD7147-25-0M7](#) [TCM0806G-350-2P-T](#)
[TCM0806G-650-2P-T](#) [IND-0110](#) [UAL21VR0802000](#) [UALSC023000000](#) [UALSC1020JH000](#) [UALSU10VD20010](#) [UALSU9VD070100](#) [36-00037](#) [UALW21HS072450](#) [UALSU9H0208000](#) [UAL24VK06450CH](#) [PLT10HH501100PNB](#) [PLT10HH401100PNB](#) [PLT10HH1026R0PNB](#)
[36-00029-01](#) [PE-67531](#) [TLH10UB](#) [113 0R5](#) [2752045447](#) [7351V](#) [CMF16-153131](#) [RD7147-6-6M0](#) [T8116NLT](#) [FE2X10-4-2NL](#) [36-00029-07](#)
[T8003NLT](#) [CTX01-13663](#) [CTX66-19521-R](#) [RC212-0.5-10M](#) [RC112-0.4-15M](#) [RC212-0.6-6M8](#) [RC212-0.4-15M](#) [RC112-0.3-30M](#)
[WTCF2012Z0M751PB](#) [PH9408.814NLT](#) [PAC6006.364NLT](#) [PAC6006.444NLT](#) [PAC6006.204NLT](#) [PH9407.204NLT](#) [PAC6006.264NLT](#)
[PH9408.494NLT](#) [PAC6006.104NLT](#) [CM6350R-683-REEL](#)