



# SMD PULSE TRANSFORMER

Meets IEEE 802.3at Standards.  
Designed For 1G,2.5G/5G BASE-T Applications, Surface Mount Type.  
Operating Temperature Range: -40 °C to +85°C.  
RoHS Compliant.



Part Number	Electrical Specifications @25°C						
	Turns Ratio (±5%)	OCL(uH Min) @100KHz,0.1V With 10.8mA DC Bias	CWW(pF Max) @100KHz,0.1V	DCR (Ω Max)	Insertion Loss (dB Max)	Return Loss (dB Min)	HI-POT (Vrms)
FB020G00	1CT:1CT	120	35	3.0	-0.5@1-50MHz -1.0@50-125MHz -2.0@125-250MHz	-18@1-40MHz -18+10*Log(F/40) @40-250MHz	1500

## MECHANICAL

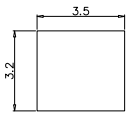

TOP VIEW

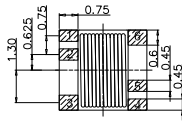

BOTTOM VIEW

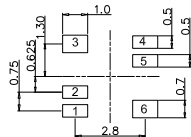

SUGGEST LAYOUT

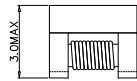

FRONT VIEW

## SCHEMATICS

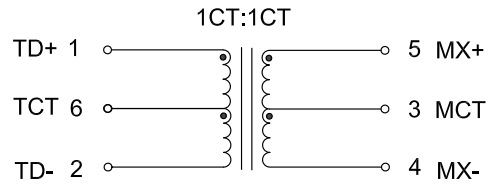

## TAPING AND PACKING

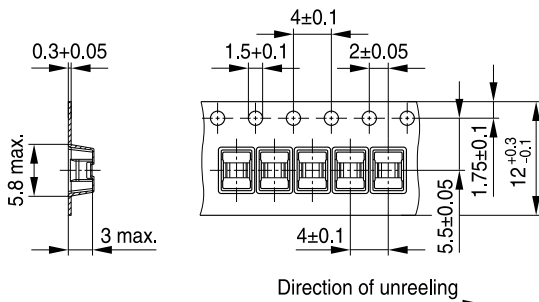

IND1752-J-E

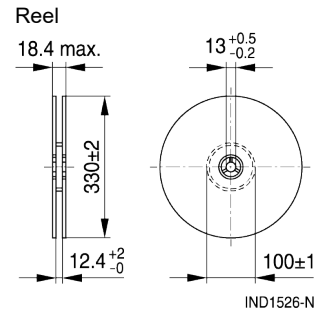

Dimensions in mm

Quantity (pcs):  
2000 PCS PER REEL  
50 REELS PER CARTON  
100000 PCS PER CARTON

## X-ON Electronics

Largest Supplier of Electrical and Electronic Components

*Click to view similar products for [Pulse Transformers](#) category:*

*Click to view products by [CND-tek](#) manufacturer:*

Other Similar products are found below :

[E4001NLT](#) [1879401-1](#) [IF-18-0269-N](#) [T1042NLT](#) [G501](#) [PT5010](#) [PE-65457NLT](#) [HM2101NLT](#) [CTX33-18971-R](#) [PG1427.001NLT](#)  
[B78307X0001](#) [CL4532A-201](#) [TS8121CMHF](#) [PA2748NLT](#) [PE-68023NLT](#) [FB020G00](#) [TS21CHF](#) [TXF353229NF-121-P1](#) [HR601233E](#)  
[CEP99B-272](#) [FC-SLF6030-330](#) [FC-STR7040-3.3V-5V](#) [FC-ST6030-401M-T](#) [FC-FCM5030B-102M-L](#) [FC-SMT1036-451-T](#) [FC-TSE050-5V-](#)  
[12V-T](#) [FC-DT8010-101-T](#) [FC-TCH1065-230Y-T](#) [FB020G00](#) [TGMR-512V6LF](#) [B78307A2276A003](#) [HX6106NLT](#) [P0926NL](#) [TGMR-](#)  
[430V8LF](#) [TGMR-501V6LF](#) [HX6096NL](#) [PE-63387NL](#) [B82804A0304A225](#) [TGM-040P3RL](#) [PA3493NLT](#) [CX2147NLT](#) [HM41-11210LF](#)  
[TGM-240NSRL](#) [TGMR-511V6LF](#) [TGM-240NSLF](#) [TGM-030P3RL](#) [T60403-F5046-X007](#) [TGM-H280V8LF](#) [T60403-D4097-X052](#)  
[HU4103NL](#)