

REV.	ECN NO.	DESCRIPTION	DATE	DESIGN
A				

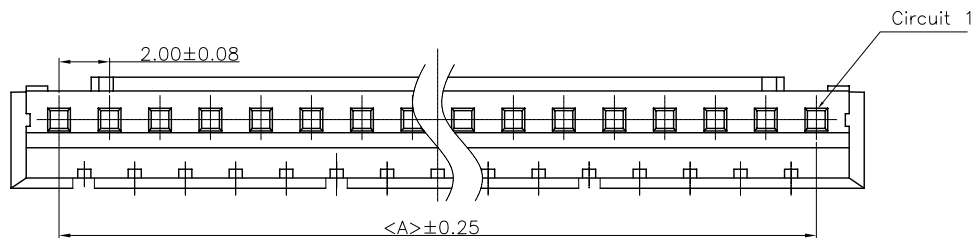

NOTES:

CURRENT RATING: 2A AC/DC.
 VOLTAGE RATING: 100V AC/DC
 TEMPERATURE RANGE: -40°C ~ +105°C.
 CONTACT RESISTANCE: 0.10MΩ Max.
 INSULATION RESISTANCE: 1000MΩ Min.
 WITHSTANDING VOLTAGE: 800V AC/MINUTE.
 MATERIAL: PA66 UL94V0.

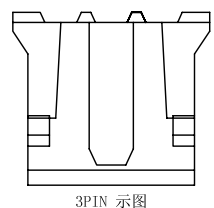
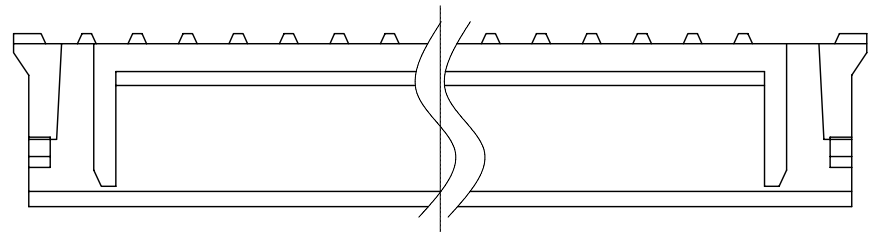
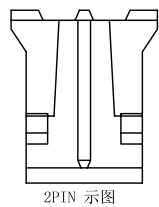
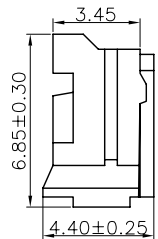
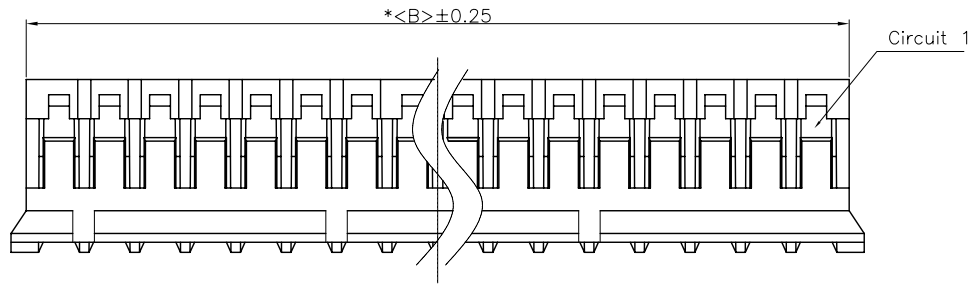

PART NO.	DIMENSIONS	
	A	B
A2001H-02P	2.00	4.60
A2001H-03P	4.00	6.60
A2001H-04P	6.00	8.60
A2001H-05P	8.00	10.60
A2001H-06P	10.00	12.60
A2001H-07P	12.00	14.60
A2001H-08P	14.00	16.60
A2001H-09P	16.00	18.60
A2001H-10P	18.00	20.60
A2001H-11P	20.00	22.60
A2001H-12P	22.00	24.60
A2001H-13P	24.00	26.60
A2001H-14P	26.00	28.60
A2001H-15P	28.00	30.60
A2001H-16P	30.00	32.60

CNJM Joint More Precision electronics Co.,Ltd.

DIM	TOL	DIM	TOL
X.	/	X'	/
X.X	0.25	X.X'	/
X.XX	0.15	X.XX'	/
X.XXX	0.10	X.XXX'	/

DRAW NO.	DATE	P/N NO:	DRAW NAME:
DESIGN: 陈雪峰	2017.06.03	A2001H-NP	2.0mm pitch housing
CHECK: 杨焯			
REVIEW:		REV. A/1	SCALE 1:1

UNIT:	SHEET:
mm	1 OF 1



REV.	ECN NO.	DESCRIPTION	DATE	DESIGN
A				

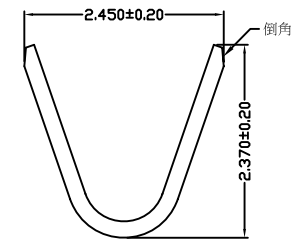
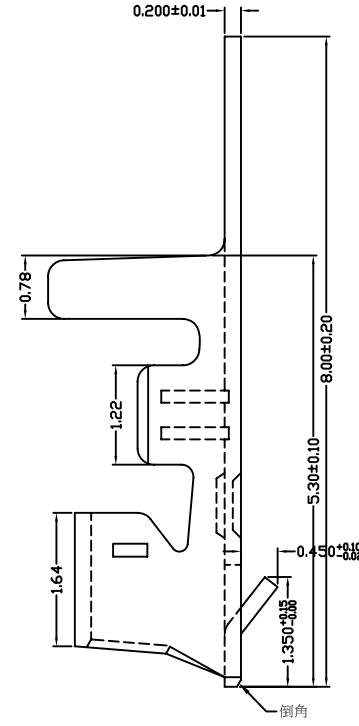
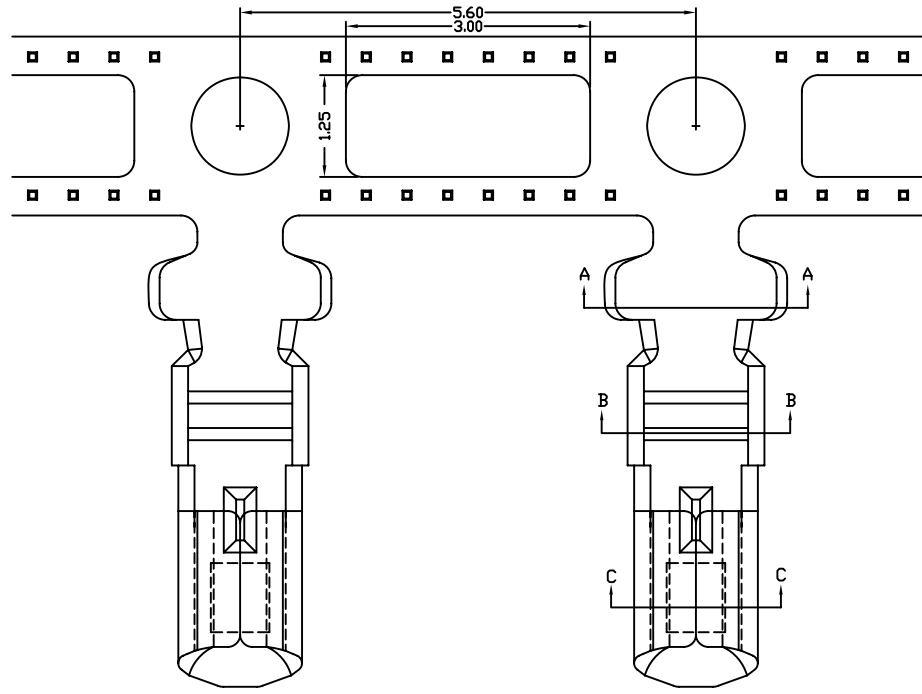

SECTION A-A

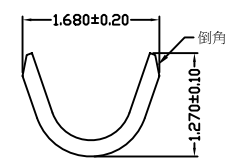

SECTION B-B

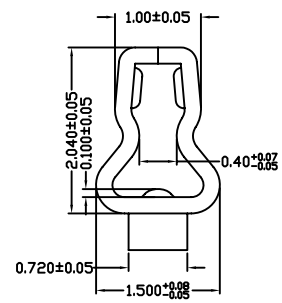

SECTION C-C

CNJM Joint More Precision electronics Co.,Ltd.

Part NO.	Wire range	Insulation O.D.	Materials	Finish	Qty/reel
A2001-TP	AWG#24-32	1.8mm(max)	Phosphor Bronze	Tin-plated	10000PCS
A2001-TPE	AWG#24-32	1.8mm(max)	Phosphor Bronze	Tin-plated	10000PCS

DIM	TOL	DIM	TOL
X.	/	X°	/
X.X	0.25	X.X*	
X.XX	0.15	X.XX*	
X.XXX	0.10	X.XXX*	/

DRAW NO.	DATE	P/N NO.	DRAW NAME:
DESIGN: 陈雪峰	2017.06.03	A2001-XXX	2.0mm pitch Terminal
CHECK: 杨焯			
REVIEW:		REV. A/1	SCALE 1:1

UNIT:	SHEET:
mm	1 OF 1



REV.	ECN NO.	DESCRIPTION	DATE	DESIGN
A				

SPECIFICATIONS

- 1) MATERIAL:
HOUSING:PA9T,UL94V-0.
TERMINAL:BRASS,TIN PLATING
- 2) CURRENT RATING:2A AC,DC.
- 3) VOLTAGE RATING:100V AC/DC
- 4) CONTACT RESISTANCE:20M OHMS MAX
- 5) INSULATION RESISTANCE:1,000M OHMS MIN.
- 6) TEMPERATURE RANGE:-40°~+105°.

Ordering Information&Dimensions:

PART NO.	Dimensions	
	A	B
A2001WR-S-02P	2.00	8.00
A2001WR-S-03P	4.00	10.00
A2001WR-S-04P	6.00	12.00
A2001WR-S-05P	8.00	14.00
A2001WR-S-06P	10.00	16.00
A2001WR-S-07P	12.00	18.00
A2001WR-S-08P	14.00	20.00
A2001WR-S-09P	16.00	22.00
A2001WR-S-10P	18.00	24.00
A2001WR-S-11P	20.00	26.00
A2001WR-S-12P	22.00	28.00
A2001WR-S-13P	24.00	30.00
A2001WR-S-14P	26.00	32.00
A2001WR-S-15P	28.00	34.00
A2001WR-S-16P	30.00	36.00

CNJM Joint More Precision electronics Co.,Ltd.

DRAW NO.	DATE	P/N NO:	DRAW NAME:
DESIGN: 陈雪峰	2017.06.03	A2001WR-S-NP-HF	2.0mm pitch 90° SMT wafer
CHECK: 杨焯			
REVIEW:		REV. A/1	SCALE 1:1
		UNIT: mm	SHEET 1 OF 1

DIM	TOL	DIM	TOL
X.	/	X°.	/
X.X	0.25	X.X°	
X.XX	0.15	X.XX°	
X.XXX	0.10	X.XXX°	/

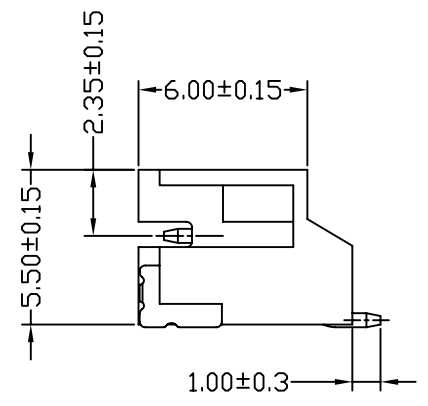
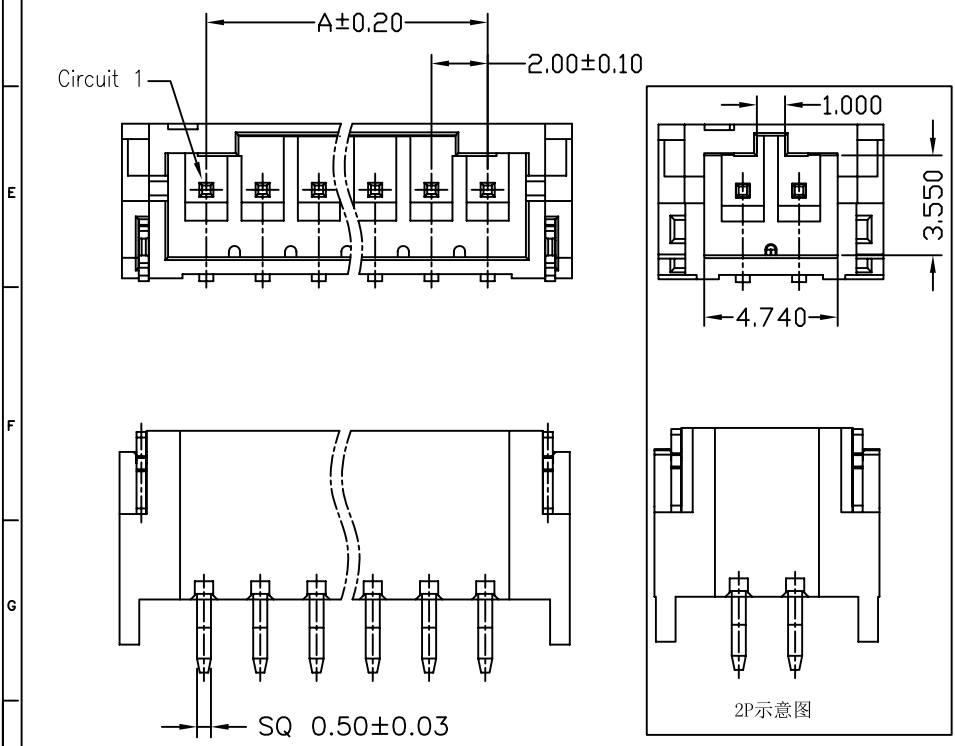
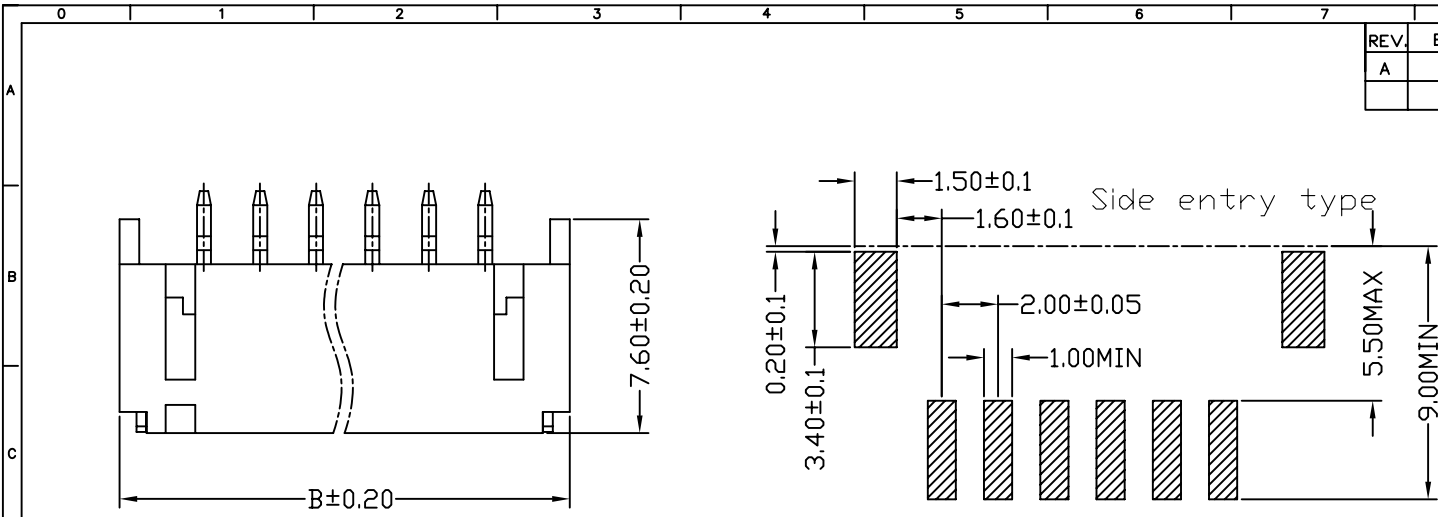

REV.	ECN NO.	DESCRIPTION	DATE	DESIGN
A				

SPECIFICATIONS

- 1) MATERIAL:
HOUSING:PA9T,UL 94V-0.
TERMINAL:BRASS,TIN PLATING
- 2) CURRENT RATING:2A AC,DC.
- 3) VOLTAGE RATING:100V AC/DC
- 4) CONTACT RESISTANCE:20M OHMS MAX
- 5) INSULATION RESISTANCE:1,000M OHMS MIN.
- 6) TEMPERATURE RANGE:-40°~+105°.

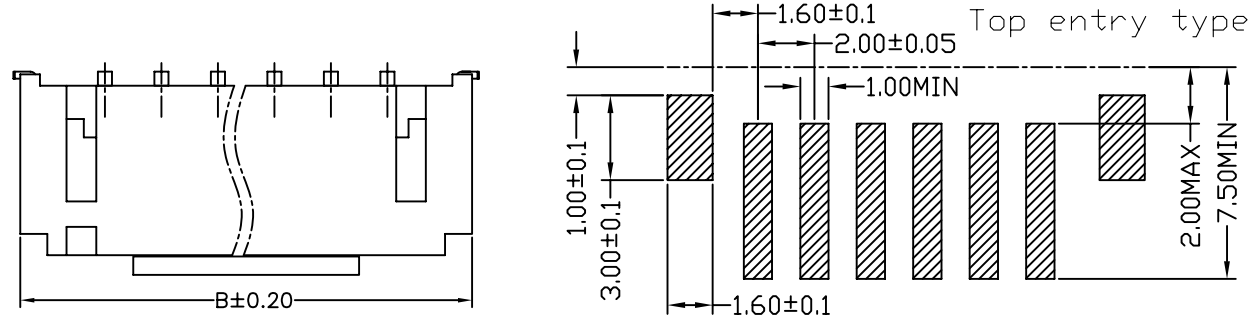

Ordering Information&Dimensions:

PART NO.	Dimensions	
	A	B
A2001WV-S-02P	2.00	8.00
A2001WV-S-03P	4.00	10.00
A2001WV-S-04P	6.00	12.00
A2001WV-S-05P	8.00	14.00
A2001WV-S-06P	10.00	16.00
A2001WV-S-07P	12.00	18.00
A2001WV-S-08P	14.00	20.00
A2001WV-S-09P	16.00	22.00
A2001WV-S-10P	18.00	24.00
A2001WV-S-11P	20.00	26.00
A2001WV-S-12P	22.00	28.00
A2001WV-S-13P	24.00	30.00
A2001WV-S-14P	26.00	32.00
A2001WV-S-15P	28.00	34.00
A2001WV-S-16P	30.00	36.00

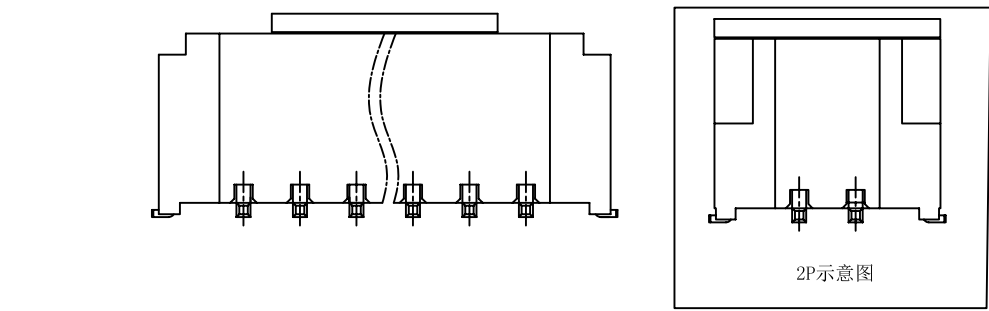
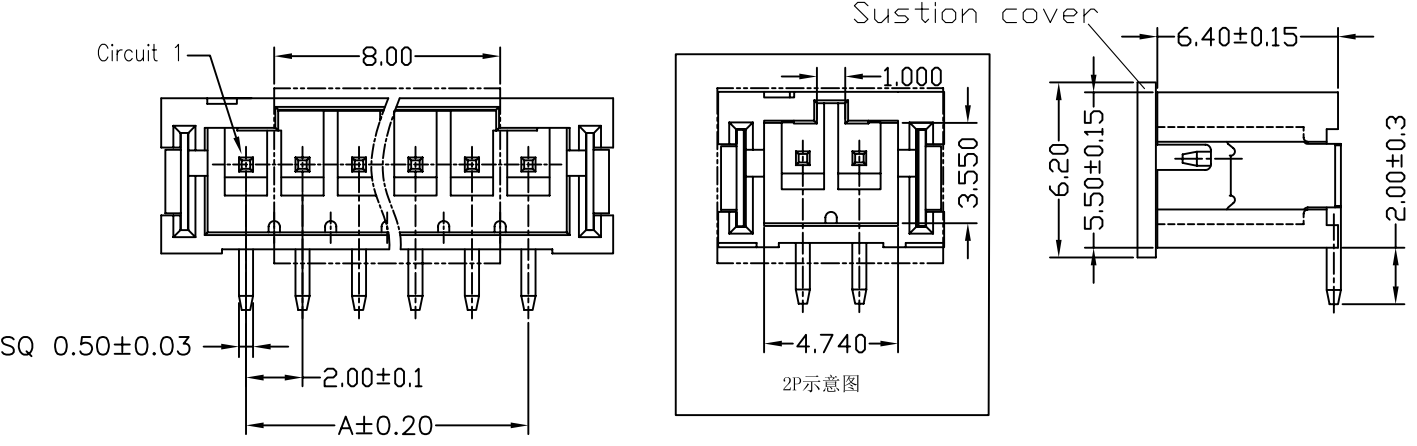

CNJM Joint More Precision electronics Co.,Ltd.

DRAW NO.	DATE	P/N NO.	DRAW NAME:
DESIGN: 陈雪峰	2017.06.03	A2001WV-S-NP-HF	2.0mm pitch 180° SMT wafer
CHECK: 杨 焯			
REVIEW:		REV. A/1 SCALE 1:1	UNIT: mm SHEET 1 OF 1

DIM	TOL	DIM	TOL
X.	/	X*	/
X.X	0.25	X.X*	
X.XX	0.15	X.XX*	
X.XXX	0.10	X.XXX*	/

REV.	ECN NO.	DESCRIPTION	DATE	DESIGN
A				

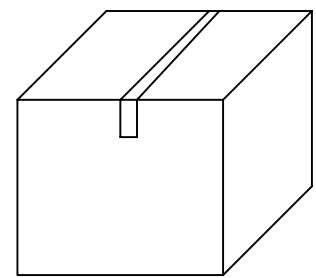
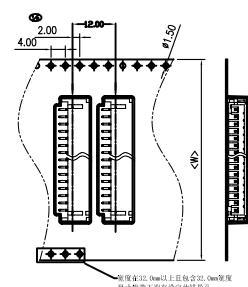
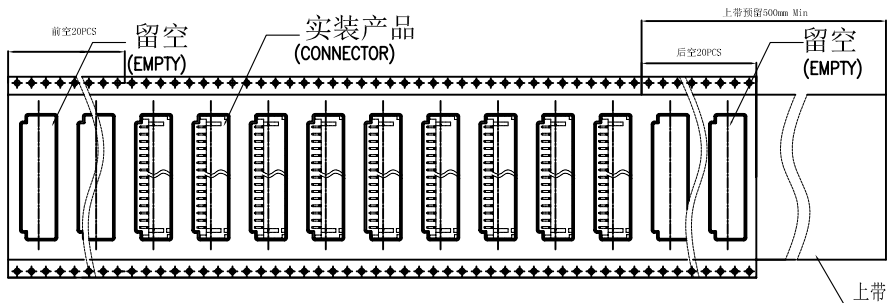

收料方向 GATHER MATERIAL DIRECTION
 客户放料方向 INPUT MATERIAL DIRECTION

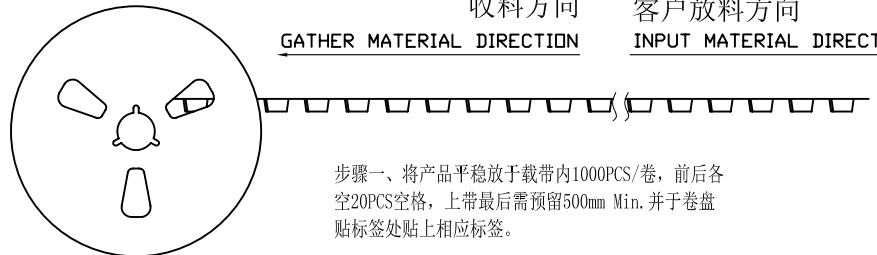

步骤一、将产品平稳放于载带内1000PCS/卷，前后各空20PCS空格，上带最后需预留500mm Min. 并于卷盘贴标签处贴上相应标签。

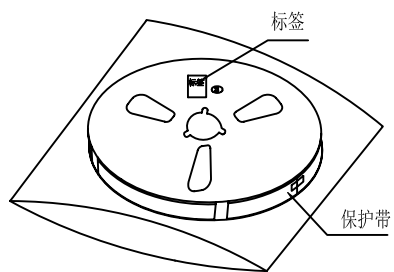

步骤二、在卷盘表层增加一层保护带，并在卷盘四周贴上美纹带，再套上1PCS高密度PE袋，包装好后，需在包装卷盘上贴上产品标签，注明产品名称及数量等。

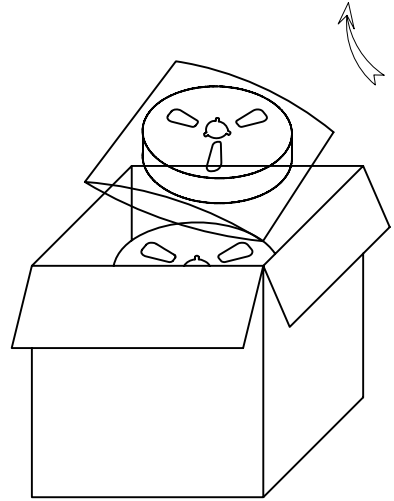

步骤三、将封装好的卷盘放入纸箱，然后用胶带将纸箱封闭，并在纸箱上指定的位置贴上相应标签，注明产品名称及数量、生产日期等。

Dimensions	载带尺寸	盘箱
B	W	Reel/Box
2P	24	14
3P		
4P		
5P	32	10
6P		
7P		
8P		
9P	44	7
10P		
11P		
12P		
13P		
14P	56	6
15P		
16P		

DIM	TOL	DIM	TOL
X.	/	X*	/
X.X	0.25	X.X*	
X.XX	0.15	X.XX*	
X.XXX	0.10	X.XXX*	/

CNJM Joint More Precision electronics Co.,Ltd.

DRAW NO.	DATE	P/N NO:	DRAW NAME:
DESIGN: 陈雪峰	2017.06.03		PH2.0 SMT 90° 包装规格
CHECK: 杨 烨			
REVIEW:		REV. A/1	SCALE 1:1
		UNIT: mm	SHEET: 1 OF 1

REV.	ECN NO.	DESCRIPTION	DATE	DESIGN
A				

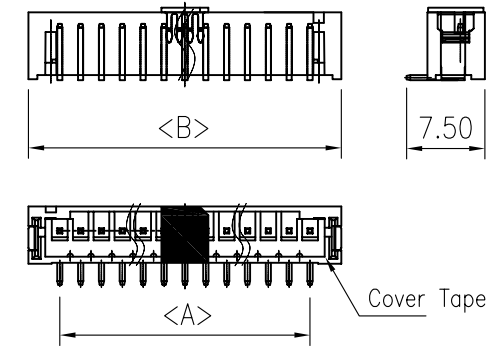
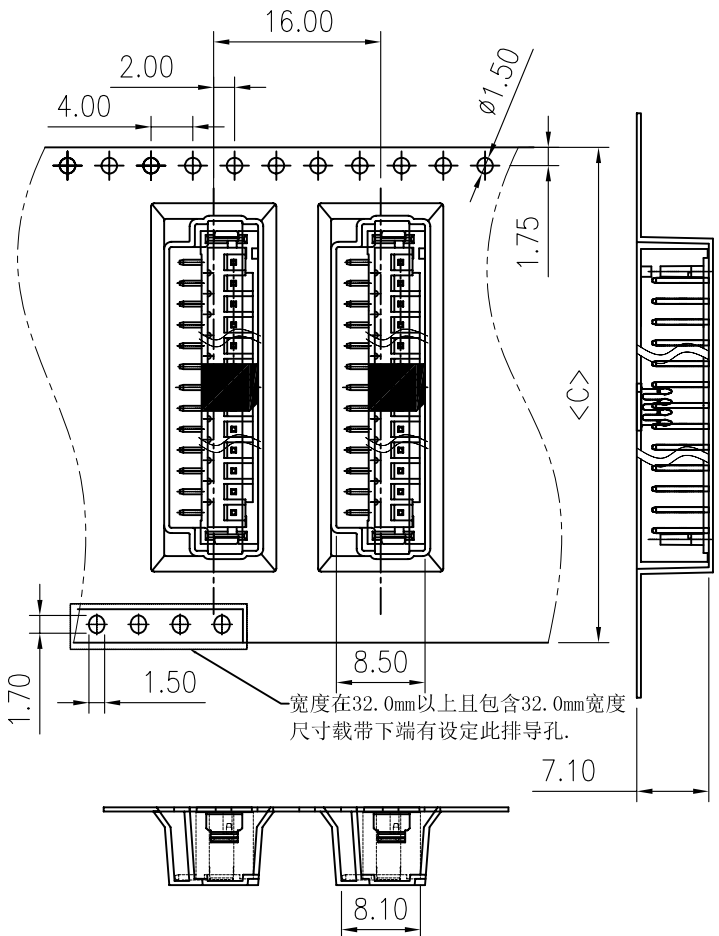
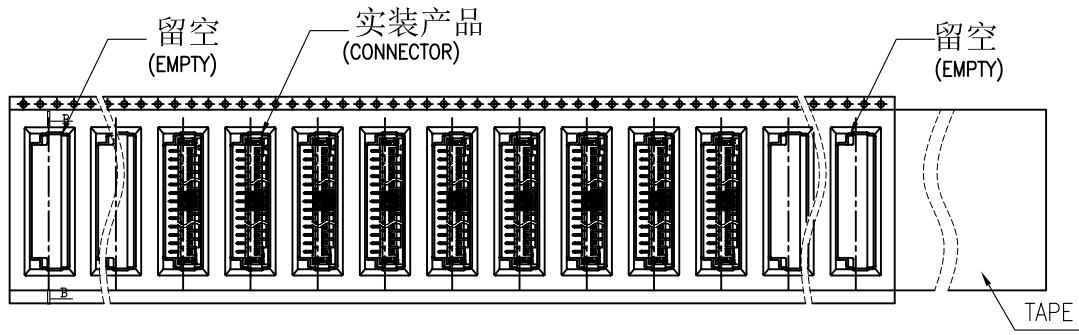
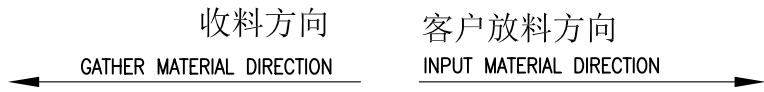
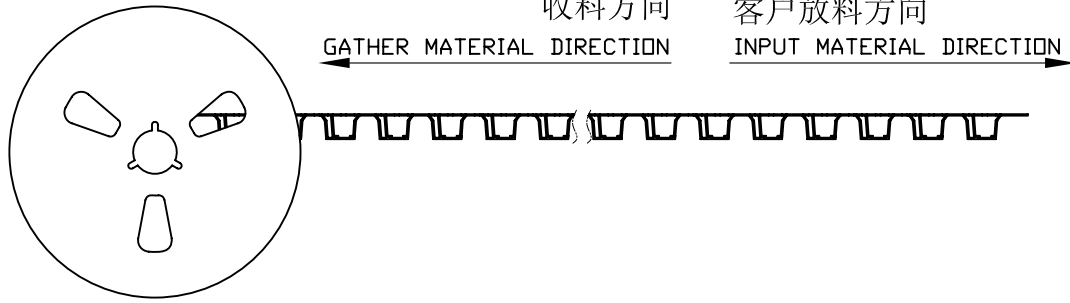

Part No.	Dimensions		载带尺寸 C	Reel/Box
	A	B		
A2001WV-S-02P	2.00	8.00	24.0	12
A2001WV-S-03P	4.00	10.00		
A2001WV-S-04P	6.00	12.00		
A2001WV-S-05P	8.00	14.00	32.0	10
A2001WV-S-06P	10.00	16.00		
A2001WV-S-07P	12.00	18.00		
A2001WV-S-08P	14.00	20.00	44.0	8
A2001WV-S-09P	16.00	22.00		
A2001WV-S-10P	18.00	24.00		
A2001WV-S-11P	20.00	26.00	56.0	6
A2001WV-S-12P	22.00	28.00		
A2001WV-S-13P	24.00	30.00		
A2001WV-S-14P	26.00	32.00		
A2001WV-S-15P	28.00	34.00		
A2001WV-S-16P	30.00	36.00		

CNJM Joint More Precision electronics Co.,Ltd.

DRAW NO.	DATE	P/N NO.	DRAW NAME:
DESIGN: 陈雪峰	2017.06.03		PH2.0 SMT 180°包装规格
CHECK: 杨焯			
REVIEW:		REV. A/1	SCALE 1:1
		UNIT: mm	SHEET: 1 OF 1

DIM	TOL	DIM	TOL
X.	/	X°.	/
X.X	0.25	X.X°	
X.XX	0.15	X.XX°	
X.XXX	0.10	X.XXX°	/

X-ON Electronics

Largest Supplier of Electrical and Electronic Components

Click to view similar products for [Headers & Wire Housings](#) category:

Click to view products by [CNJM](#) manufacturer:

Other Similar products are found below :

[57102-F02-18ULF](#) [58102-G61-06LF](#) [0009485154](#) [009176003701906](#) [0050291907](#) [02.125.8002.8](#) [609-3404](#) [61062-3](#) [622-0430](#) [622-3653LF](#)
[63453-116](#) [636-1030](#) [636-1427](#) [636-3427](#) [636-4007](#) [641938-9](#) [644827-2](#) [65495-038](#) [65692-001LF](#) [65781-018](#) [65781-047](#) [65817-010LF](#)
[65817-015LF](#) [66207-023LF](#) [67016-026LF](#) [67095-007LF](#) [68631-112](#) [68645-018](#) [68648-049](#) [699319-000](#) [70.362.1628.0](#) [70-4210](#) [70-4226B](#)
[70-4853B](#) [707-5020](#) [707-5028](#) [71.350.2428.0](#) [71961-016LF](#) [733-134](#) [754199-000](#) [760-3052](#) [787-8014-00](#) [FCN-367T-T012/H](#) [80.063.4001.1](#)
[800-90-010-10-002000](#) [801-43-002-10-013000](#) [801-43-006-10-002000](#) [803-41-018-10-001000](#) [803-43-014-20-001000](#) [803-43-024-10-001000](#)