

REV.	ECN NO.	DESCRIPTION	DATE	DESIGN
A		变更料号	16/11/22	苏亮

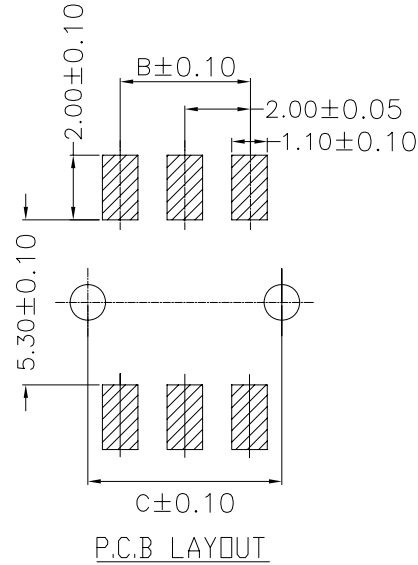

Specifications:
 Current rating:3A AC/DC.
 Voltage rating:250V AC/DC
 Temperature range:-40°C~+105°C.
 Contact resistance:10MΩ Max.
 Insulation resistance:1000MΩ Min.
 Withstanding voltage: 800V AC/minute.
 Material:pa9t 94v0.

PART NO.	Dimensions		
	A	B	C
A2006WV-S-F-2X02P	6.00	2.00	4.00
A2006WV-S-F-2X03P	8.00	4.00	6.00
A2006WV-S-F-2X04P	10.00	6.00	8.00
A2006WV-S-F-2X05P	12.00	8.00	10.00
A2006WV-S-F-2X06P	14.00	10.00	12.00
A2006WV-S-F-2X07P	16.00	12.00	14.00
A2006WV-S-F-2X08P	18.00	14.00	16.00
A2006WV-S-F-2X09P	20.00	16.00	18.00
A2006WV-S-F-2X10P	22.00	18.00	20.00
A2006WV-S-F-2X11P	24.00	20.00	22.00
A2006WV-S-F-2X12P	26.00	22.00	24.00
A2006WV-S-F-2X13P	28.00	24.00	26.00
A2006WV-S-F-2X14P	30.00	26.00	28.00
A2006WV-S-F-2X15P	32.00	28.00	30.00
A2006WV-S-F-2X16P	34.00	30.00	32.00
A2006WV-S-F-2X17P	36.00	32.00	34.00
A2006WV-S-F-2X18P	38.00	34.00	36.00
A2006WV-S-F-2X19P	40.00	36.00	38.00
A2006WV-S-F-2X20P	42.00	38.00	40.00

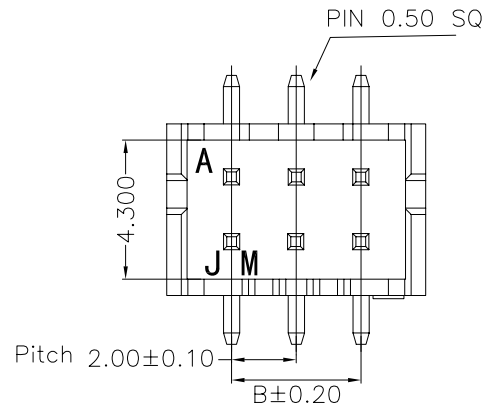
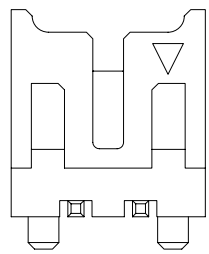

2P 视图

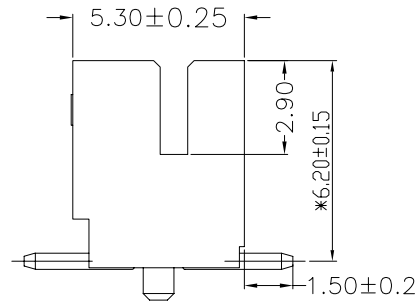
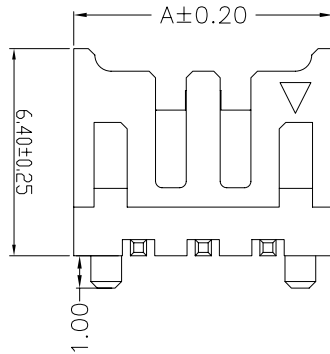

CNJM Joint More Precision electronics Co.,Ltd.

DRAW NO.	DATE	P/N NO:	DRAW NAME:
DESIGN: 陈雪峰	2017.06.03	A2006WV-S-F-2XNP	2.0mm PITCH 180° DUAL ROW WAFER -SMT YTPE
CHECK: 杨焯		REV. A/1	SCALE 1:1
REVIEW:		UNIT: mm	SHEET: 1 OF 1

DIM	TOL	DIM	TOL
X.	/	X°	/
X.X	0.25	X.X°	
X.XX	0.15	X.XX°	
X.XXX	0.10	X.XXX°	/

X-ON Electronics

Largest Supplier of Electrical and Electronic Components

Click to view similar products for [Headers & Wire Housings](#) category:

Click to view products by [CNJM](#) manufacturer:

Other Similar products are found below :

[57102-F02-18ULF](#) [58102-G61-06LF](#) [0009485154](#) [009176003701906](#) [0050291907](#) [02.125.8002.8](#) [609-3404](#) [61062-3](#) [622-0430](#) [622-3653LF](#)
[63453-116](#) [636-1030](#) [636-1427](#) [636-3427](#) [636-4007](#) [641938-9](#) [644827-2](#) [65495-038](#) [65692-001LF](#) [65781-018](#) [65781-047](#) [65817-010LF](#)
[65817-015LF](#) [66207-023LF](#) [67016-026LF](#) [67095-007LF](#) [68631-112](#) [68645-018](#) [68648-049](#) [699319-000](#) [70.362.1628.0](#) [70-4210](#) [70-4226B](#)
[70-4853B](#) [707-5020](#) [707-5028](#) [71.350.2428.0](#) [71961-016LF](#) [733-134](#) [754199-000](#) [760-3052](#) [787-8014-00](#) [FCN-367T-T012/H](#) [80.063.4001.1](#)
[800-90-010-10-002000](#) [801-43-002-10-013000](#) [801-43-006-10-002000](#) [803-41-018-10-001000](#) [803-43-014-20-001000](#) [803-43-024-10-001000](#)