

REV.	ECN NO.	DESCRIPTION	DATE	DESIGN
A				

Specifications:
 Current rating:3A AC/DC.
 Voltage rating:250V AC/DC
 Temperature range:-40°C~+105°C.
 Contact resistance:30MΩ Max.
 Insulation resistance:1000MΩ Min.
 Withstanding voltage: 1000V AC/minute.
 Material:PA66.Ul94V-0.

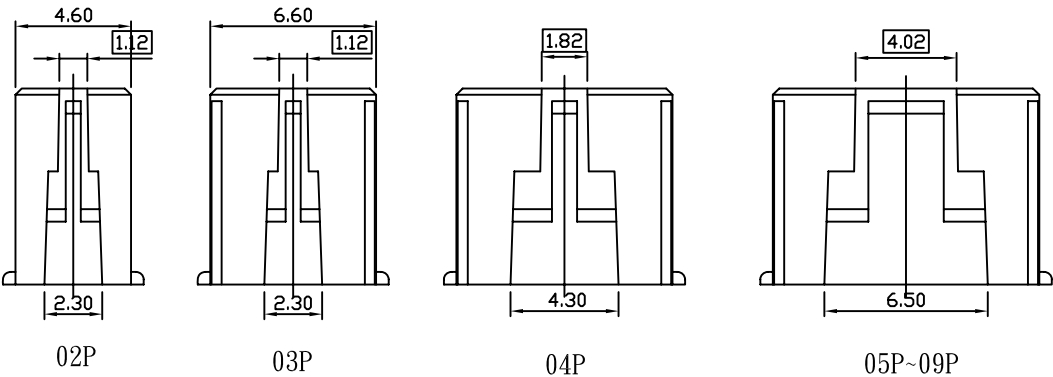

02P

03P

04P

05P~09P

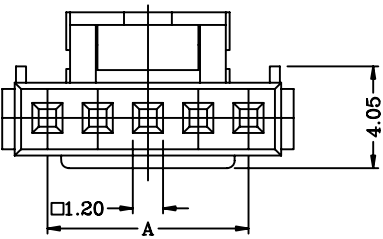

10P~16P

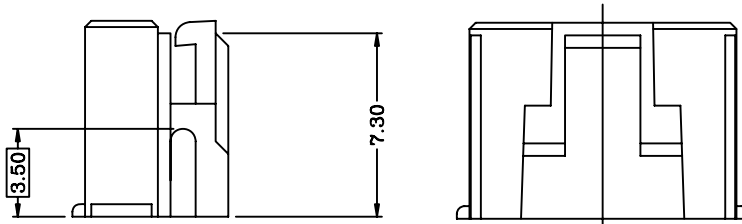
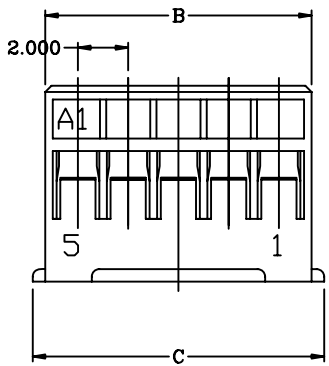

PART NO.	Dimensions		
	A	B	C
A2008H-02P	2.00	4.60	5.60
A2008H-03P	4.00	6.60	7.60
A2008H-04P	6.00	8.60	9.60
A2008H-05P	8.00	10.60	11.60
A2008H-06P	10.00	12.60	13.60
A2008H-07P	12.00	14.60	15.60
A2008H-08P	14.00	16.60	17.60
A2008H-09P	16.00	18.60	19.60
A2008H-10P	18.00	20.60	21.60
A2008H-11P	20.00	22.60	23.60
A2008H-12P	22.00	24.60	25.60
A2008H-13P	24.00	26.60	27.60
A2008H-14P	26.00	28.60	29.60
A2008H-15P	28.00	30.60	31.60
A2008H-16P	30.00	32.60	33.60

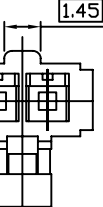
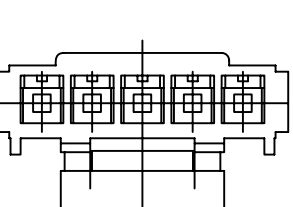

大于03P

02P

DIM	TOL	DIM	TOL
X.	/	X*	/
X.X	0.25	X.X*	
X.XX	0.15	X.XX*	
X.XXX	0.10	X.XXX*	/

CNJM Joint More Precision electronics Co.,Ltd.

DRAW NO.	DATE	P/N NO.	DRAW NAME:
DESIGN: 陈雪峰	2017.06.03	A2008H-NP	2.0mm pitch housing
CHECK: 杨 焯			
REVIEW:		REV. A/1	SCALE 1:1
		UNIT: mm	SHEET: 1 OF 1

REV.	ECN NO.	DESCRIPTION	DATE	DESIGN
A				

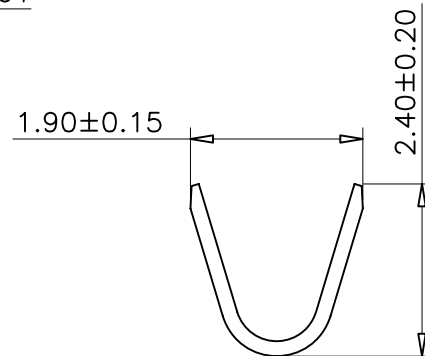
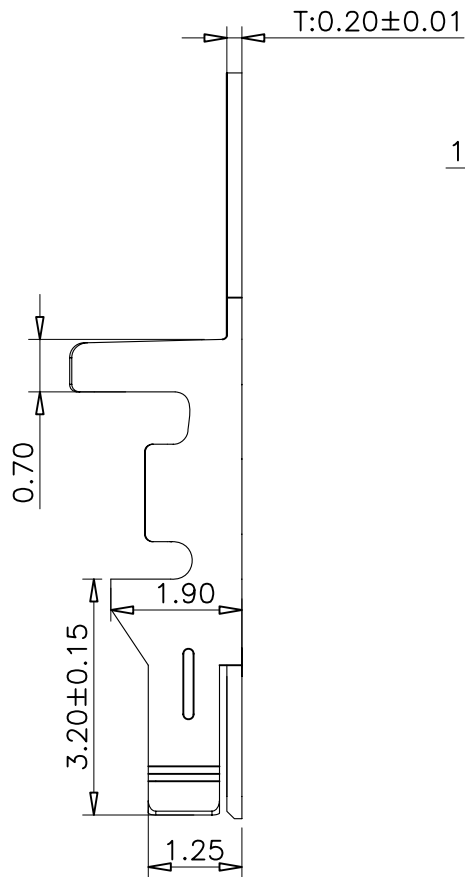
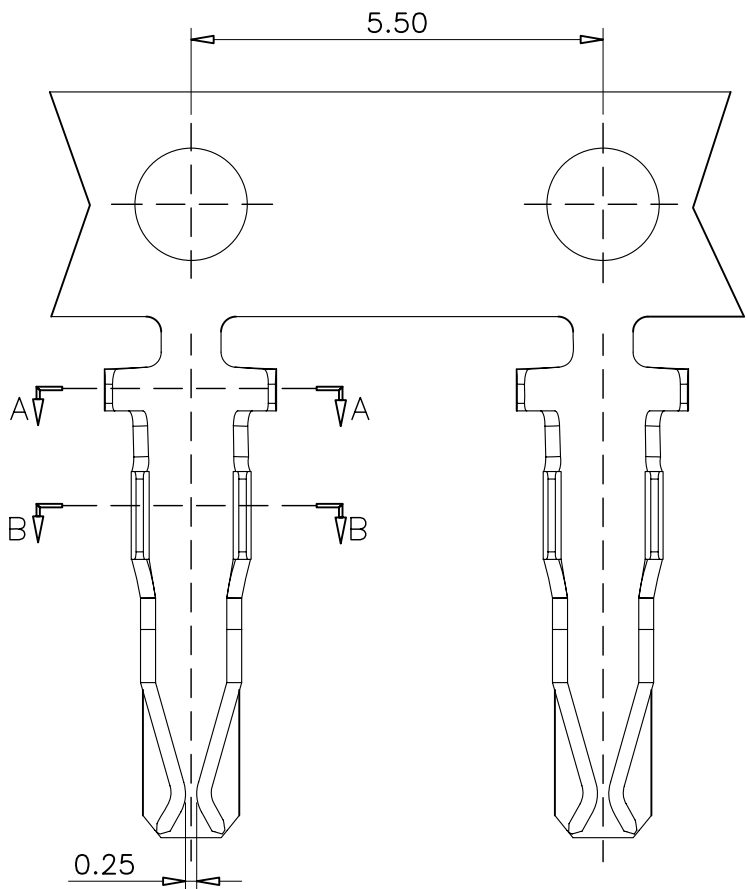

SECTION: (A-A)

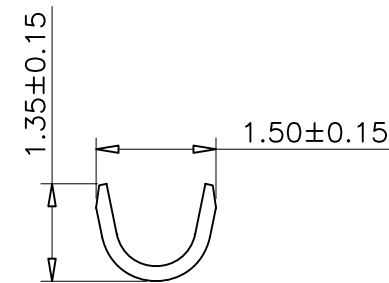

SECTION: (B-B)

CNJM Joint More Precision electronics Co.,Ltd.

Part NO.	Wire range	Insulation O.D.	Materials	Finish	Qty/reel
A2008-TP	AWG#28-32	0.8mm(max)	Phosphor Bronze	Tin-plated	10000PCS
A2008-TPE	AWG#26-32	0.8mm(max)	Phosphor Bronze	Tin-plated	10000PCS

DIM	TOL	DIM	TOL
X.	/	X.	/
X.X	0.25	X.X'	/
X.XX	0.15	X.XX'	/
X.XXX	0.10	X.XXX'	/

DRAW NO.	DATE	P/N NO:	DRAW NAME:
DESIGN: 陈雪峰	2017.06.03	A2008-XXX	2.0mm pitch terminal
CHECK: 杨焱			
REVIEW:		REV. A/1	SCALE 1:1
		UNIT: mm	SHEET: 1 OF 1

REV	ECN NO.	DESCRIPTION	DATE	DESIGN
A		NEW	10.03.02	肖勇

Specifications:
 Current rating:3A AC/DC.
 Voltage rating:250V AC/DC
 Temperature range:-40°C~+105°C.
 Contact resistance:30MΩ Max.
 Insulation resistance:1000MΩ Min.
 Withstanding voltage: 1000V AC/minute.
 Material:PA66.UL94V-0.

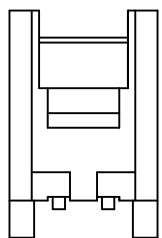
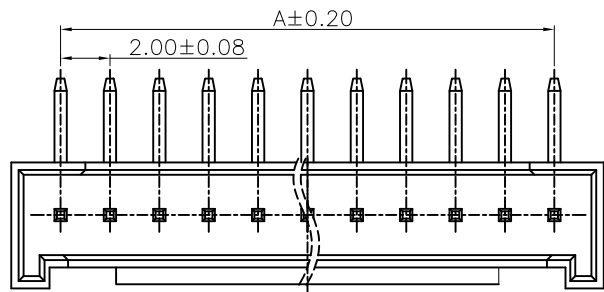

2P 示图

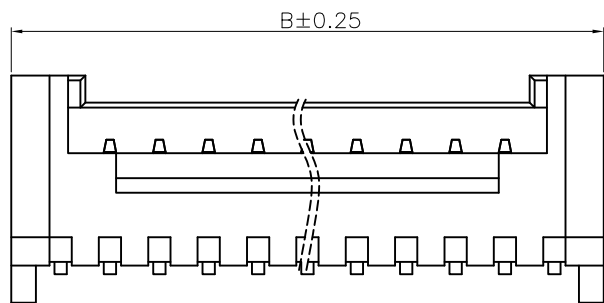
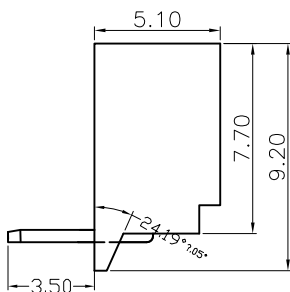

5-16P 示图

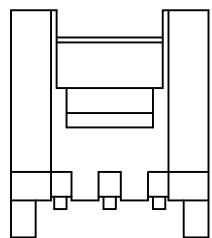

3P 示图

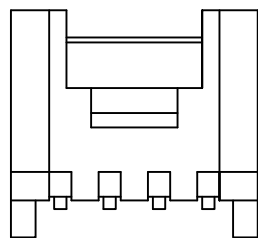

4P 示图

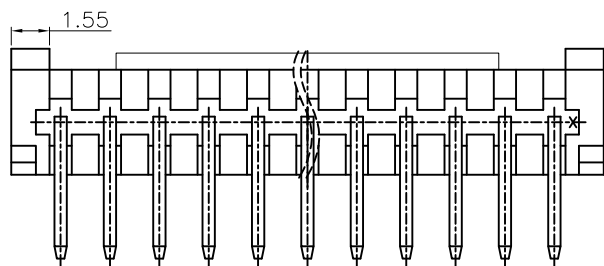

Recommended P.C.B Layout(Top Side)
 P.C.B Thickness
 (Tolerance=±0.05)

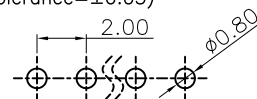

PART NO.	Dimensions	
	A	B
A2008WR-02P	2.00	6.00
A2008WR-03P	4.00	8.00
A2008WR-04P	6.00	10.00
A2008WR-05P	8.00	12.00
A2008WR-06P	10.00	14.00
A2008WR-07P	12.00	16.00
A2008WR-08P	14.00	18.00
A2008WR-09P	16.00	20.00
A2008WR-10P	18.00	22.00
A2008WR-11P	20.00	24.00
A2008WR-12P	22.00	26.00
A2008WR-13P	24.00	28.00
A2008WR-14P	26.00	30.00
A2008WR-15P	28.00	32.00
A2008WR-16P	30.00	34.00

CJMP Joint More Precision electronics Co.,Ltd.

DRAW NO.	A2012WR	DATE	P/N NO:	DRAW NAME:
DESIGN:	肖勇	10.03.02	A2008WR-NP	然湖2.0 90° Wafer
CHECK:			REV. A	SCALE 1:1
REVIEW:			UNIT: mm	SHEET: 1 OF 1

DIM	TOL	DIM	TOL
X.	/	X°	/
X.X	±0.25	X.X°	±2°
X.XX	±0.20	X.XX°	±1°
X.XXX	±0.10	X.XXX°	/

REV.	ECN NO.	DESCRIPTION	DATE	DESIGN
A				

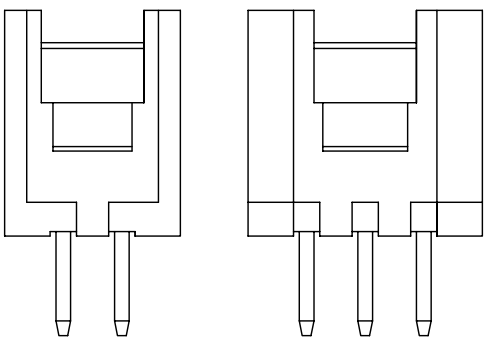
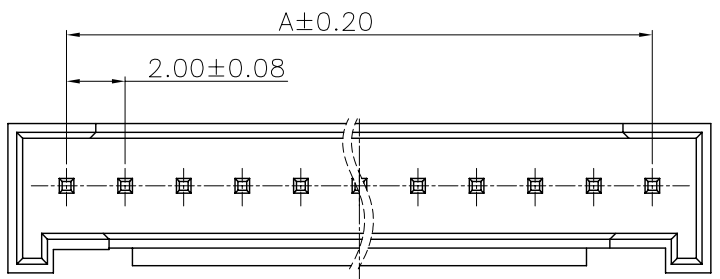

2P示图

3P示图

Specifications:
 Current rating: 3A AC/DC.
 Voltage rating: 250V AC/DC
 Temperature range: $-40^{\circ}\text{C} \sim +105^{\circ}\text{C}$.
 Contact resistance: 30M Ω Max.
 Insulation resistance: 1000M Ω Min.
 Withstanding voltage: 1000V AC/minute.
 Material: PA66.UL94V-0.

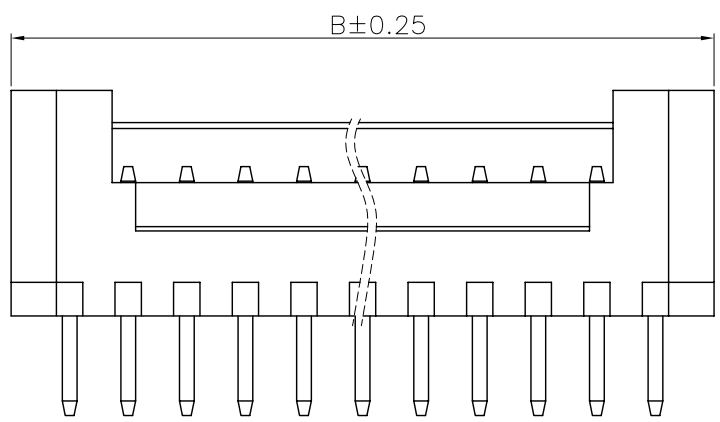

5-16P示图

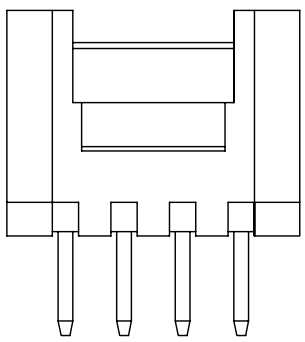

4P示图

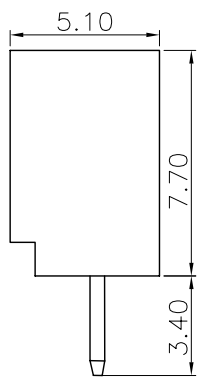

PART NO.	Dimensions	
	A	B
A2008WV-02P	2.00	6.00
A2008WV-03P	4.00	8.00
A2008WV-04P	6.00	10.00
A2008WV-05P	8.00	12.00
A2008WV-06P	10.00	14.00
A2008WV-07P	12.00	16.00
A2008WV-08P	14.00	18.00
A2008WV-09P	16.00	20.00
A2008WV-10P	18.00	22.00
A2008WV-11P	20.00	24.00
A2008WV-12P	22.00	26.00
A2008WV-13P	24.00	28.00
A2008WV-14P	26.00	30.00
A2008WV-15P	28.00	32.00
A2008WV-16P	30.00	34.00

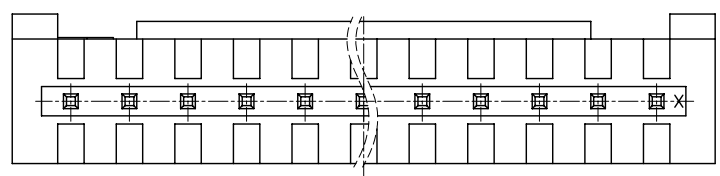

Recommended P.C.B Layout (Top Side)

P.C.B Thickness
(Tolerance = ± 0.05)

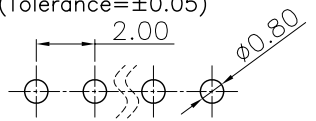

DIM	TOL	DIM	TOL
X.	/	X'	/
X.X	0.25	X.X'	
X.XX	0.15	X.XX'	
X.XXX	0.10	X.XXX'	/

CNJM Joint More Precision electronics Co., Ltd.

DRAW NO.	DATE	P/N NO:	DRAW NAME:
DESIGN: 陈雪峰	2017.06.03	A2008WV-NP	2.0mm pitch 180° wafer
CHECK: 杨焯		REV. A/1	SCALE 1:1
REVIEW:		UNIT: mm	SHEET: 1 OF 1

X-ON Electronics

Largest Supplier of Electrical and Electronic Components

Click to view similar products for [Headers & Wire Housings](#) category:

Click to view products by [CNJM](#) manufacturer:

Other Similar products are found below :

[57102-F02-18ULF](#) [58102-G61-06LF](#) [582553-1](#) [009176003701906](#) [01.001.5753.1](#) [0050291907](#) [02.125.8002.8](#) [609-3404](#) [61062-3](#)
[CSU011177004](#) [622-0430](#) [622-3653LF](#) [63453-116](#) [636-1030](#) [636-1427](#) [636-3427](#) [636-4007](#) [641938-9](#) [644827-2](#) [65495-038](#) [65692-001LF](#)
[65781-018](#) [65781-047](#) [65817-010LF](#) [65817-015LF](#) [66207-023LF](#) [67095-007LF](#) [67601157](#) [68631-112](#) [68645-018](#) [699319-000](#)
[M90C108951C](#) [70.362.1628.0](#) [70-4210](#) [70-4226B](#) [70-4853B](#) [707-5028](#) [71.350.2428.0](#) [71961-016LF](#) [733-134](#) [733-162](#) [754199-000](#) [760-](#)
[3052](#) [80.063.4001.1](#) [800-90-001-10-001000](#) [800-90-010-10-002000](#) [801-43-002-10-013000](#) [801-43-006-10-002000](#) [803-41-018-10-001000](#)
[803-43-024-10-001000](#)