

AACT Series

Features

- Qualified to AEC-Q200.
- High common mode impedance at high frequency effects excellent noise suppression performance.
- Support a wide range of $-40 \sim +125^{\circ}\text{C}$, can be used for high temperature resistant vehicle equipment.
- High precision automatic winding method ensures high stability and reliability.
- The products 100% Lead(Pb) and RoHS compliant.

Applications

- The AACT series can be used as a common mode filter for vehicle LAN system such as CANBUS and FlexRay.

Test Conditions

- All test data is referenced to 25°C ambient.
 - Operating temperature range -40°C to $+125^{\circ}\text{C}$ (Including self - temperature rise).
 - The part temperature(ambient + temp rise) should not exceed 125°C under worst case operating conditions.
- Circuit design, component placement, PCB trace size and thickness, airflow and other cooling provisions all affect the part temperature, part temperature should be verified in the end application.

External dimensions (Unit:mm)

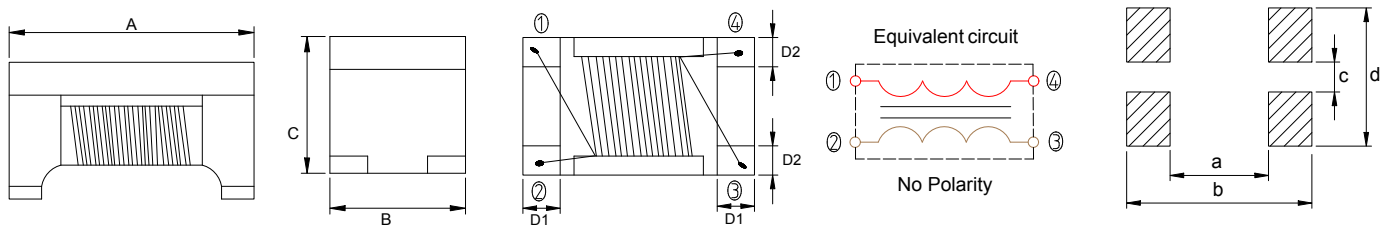

Type	A	B	C Max.	D1 Typ.	D2 Typ.	a	b	c	d	Q'Ty/Reel
AACT322523	3.2±0.2	2.5±0.2	2.3±0.2	0.8	0.9	1.9	3.7	0.75	2.55	1000
AACT453228	4.5±0.2	3.2±0.2	2.8±0.2	1.0	1.2	2.4	5.1	0.75	3.6	500

Part Number Code

AACT 322523 R 110
 A B C D

- | | |
|-------------------|---------------------|
| 1) Series Name | Common Mode Chokes |
| 2) Dimensions(mm) | 322523: 3.2x2.5x2.3 |
| 3) Tolerance | R: Reference |
| 4) Inductance | 110: 11μH |

AACT322523 Series

Part Number	Common Mode Impedance @10MHz		Common Mode Inductance @100KHz/0.1V	DC Resistance	Rated Current	Rated Voltage	Insulation Resistance
	(Ω)Min.	(Ω)Typ.	(μ H)+50%/-30% *(μ H)+30%/-20%	(Ω)Max.	(mA)Max.	(V)Max.	(M Ω)Min.
AACT322523R110	300	550	11	0.4	300	80	10
AACT322523R220	500	1100	22	0.5	250	80	10
AACT322523R510	1000	2600	51	0.7	200	80	10
AACT322523R101	2200	5100	100	1.5	150	80	10
AACT322523R201	10000	15000	*200	4.8	70	80	10
AACT322523R800G	-	-	80	2.4	70	80	10

Characteristics(Reference)

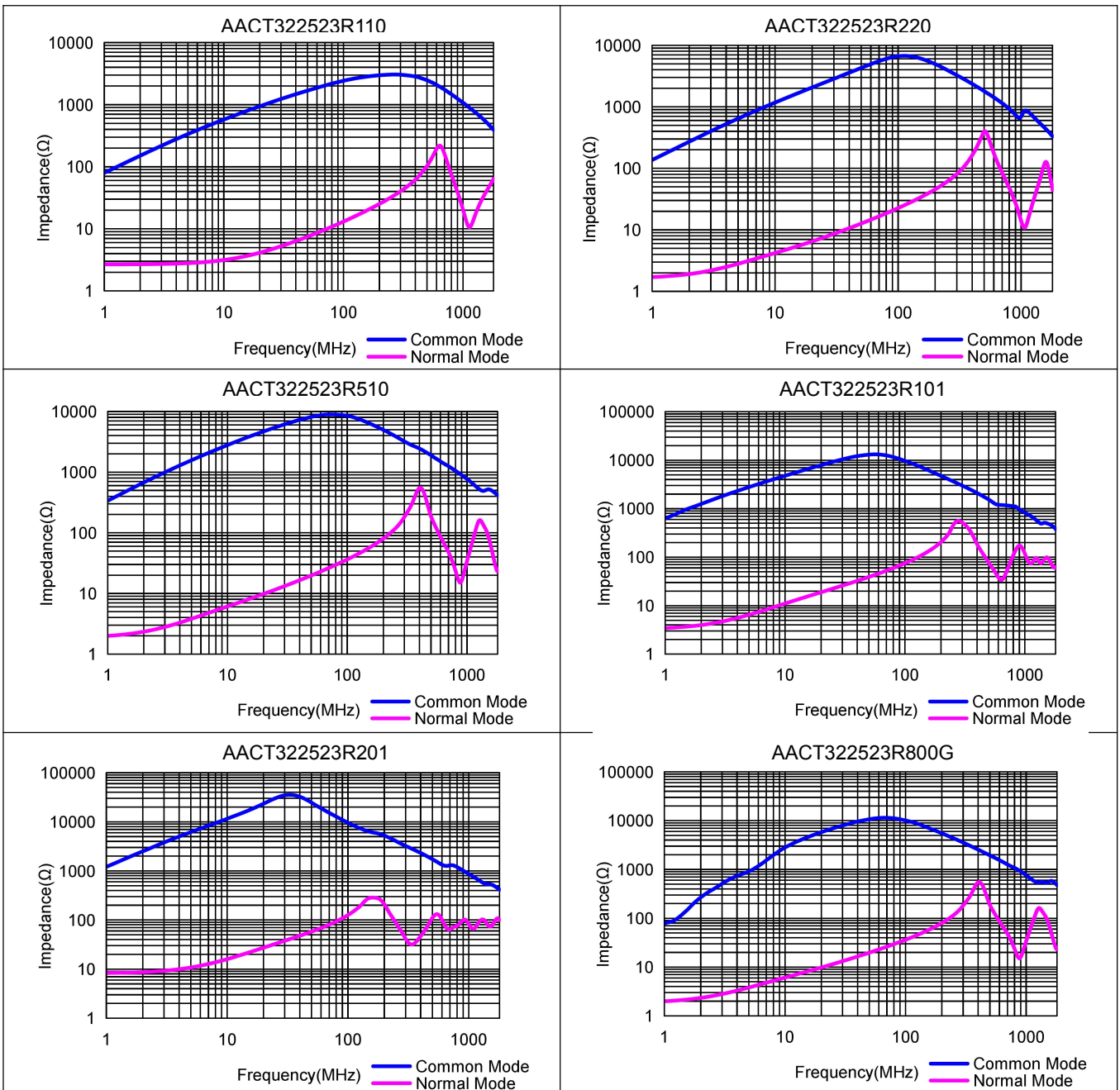

AACT453228 Series

Part Number	Common Mode Impedance @10MHz		Common Mode Inductance @100KHz/0.1V	DC Resistance	Rated Current	Rated Voltage	Insulation Resistance
	(Ω)Min.	(Ω)Typ.	(μ H)+50%/-30%	(Ω)Max.	(mA)Max.	(V)Max.	(M Ω)Min.
AACT453228R110	300	700	11	0.6	250	50	10
AACT453228R220	500	1200	22	1.0	200	50	10
AACT453228R510	1000	2800	51	1.0	200	50	10
AACT453228R101	2000	5800	100	2.0	150	50	10
AACT453228R201	10000	15000	200	4.5	100	50	10

Characteristics(Reference)

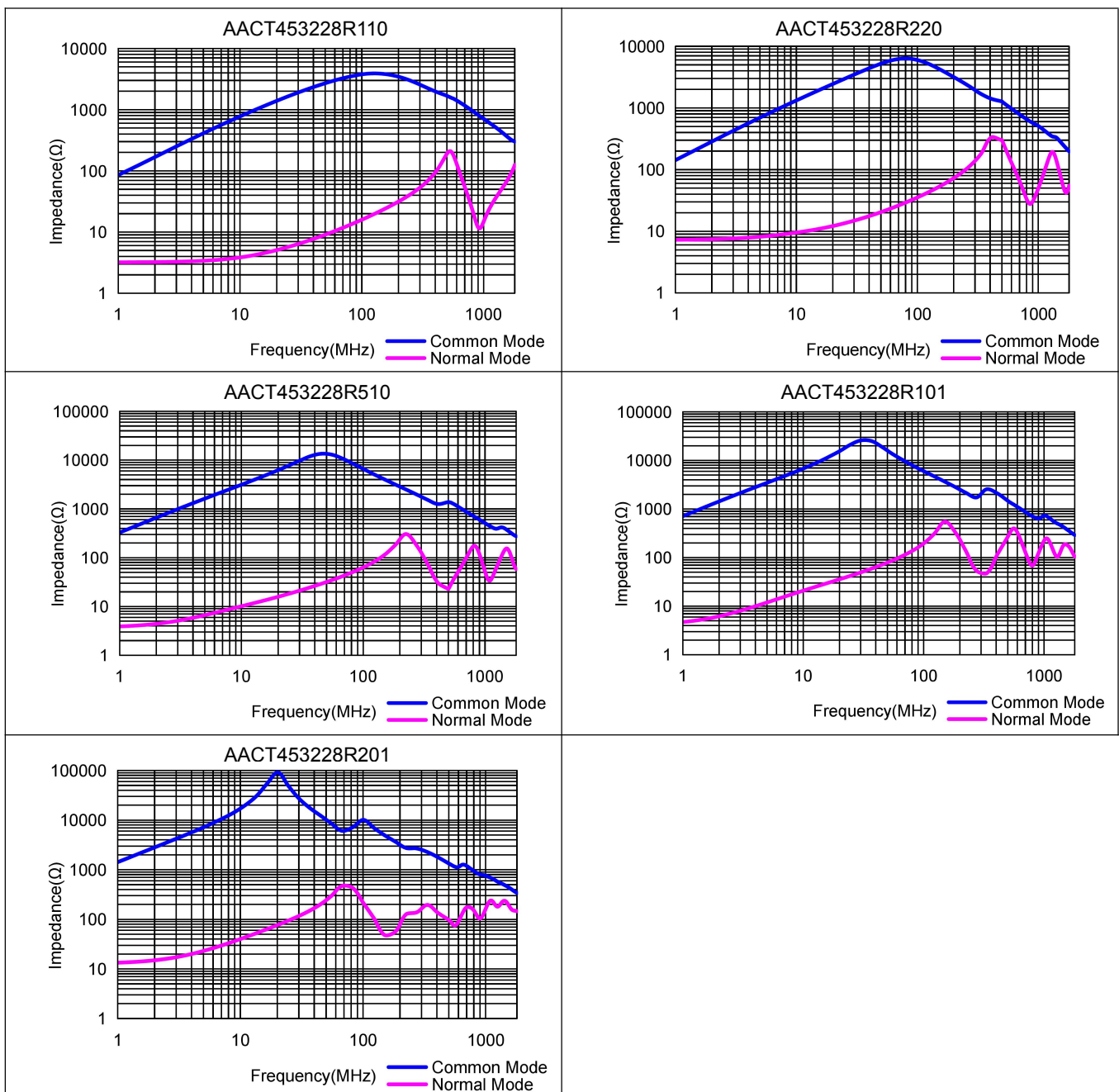

Reliability Test

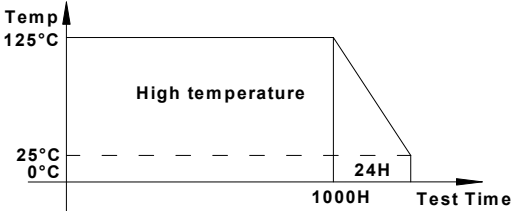
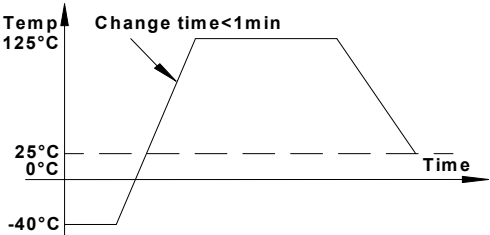
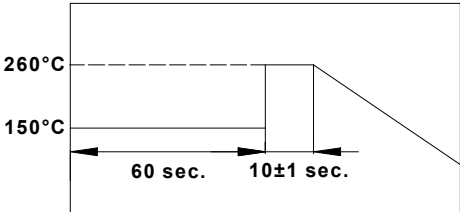
Item	Specifications	Test conditions
High temperature storage test	No visible mechanical damage. Inductance change: Within $\pm 10\%$.	Temperature: $125 \pm 2^\circ\text{C}$. Duration: 1000hrs. Measured at room temperature after placing for 24 ± 4 hrs. 
Temperature cycling test	No visible mechanical damage. Inductance change: Within $\pm 10\%$.	Condition for 1 cycle. Step1: $-40 \pm 2^\circ\text{C}$ 30min Min. Step2: $125 \pm 2^\circ\text{C}$, transition time 1min Max. Step3: $125 \pm 2^\circ\text{C}$ 30min Min. Step4: Low temp, transition time 1min Max. Number of cycles: 1000. Measured at room temperature after placing for 24 ± 4 hrs. 
Biased humidity test	No visible mechanical damage. Inductance change: Within $\pm 10\%$.	Humidity : $85\% \pm 3$ RH. Temperature: $85^\circ\text{C} \pm 2^\circ\text{C}$. Duration : 1000hrs. Measured at room temperature after placing for 24 ± 4 hrs.
Operational life test	No visible mechanical damage. Inductance change: Within $\pm 10\%$.	Temperature: $105 \pm 2^\circ\text{C}$. Duration : 1000hrs. Measured at room temperature after placing for 24 ± 4 hrs.
Resistance to solvent test	No visible mechanical damage. Inductance change: Within $\pm 10\%$.	Add aqueous wash chemical - OKEM clean or equivalent.
Vibration test	No visible mechanical damage. Inductance change: Within $\pm 10\%$.	Oscillation Frequency: $10 \sim 2\text{K} \sim 10\text{Hz}$ for 20 minute. Total Amplitude: $1.52\text{mm} \pm 10\%$. Testing Time : 12 hours (20 minutes, 12 cycles each of 3 orientations).
Resistance to soldering heat test	No visible mechanical damage. Inductance change: Within $\pm 10\%$.	Temperature ($^\circ\text{C}$): 260 ± 5 (solder temp). Time (s): 10 ± 1 . ramp/immersion and emersion rate: $25\text{mm/s} \pm 6$ mm/s. Number of heat cycles: 1. 

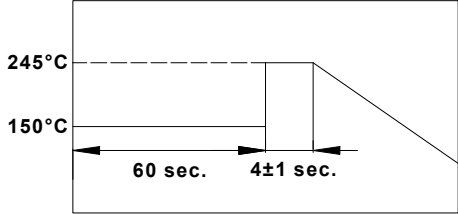
Item	Specifications	Test conditions
Solderability test	More than 95% of the terminal electrode should be covered with solder.	Steam Aging: 8 hours \pm 15 min. Preheat: 150°C, 60sec. Solder: Sn99.5%-Cu0.5%. Temperature: 245 \pm 5°C. Flux for lead free: Rosin. 9.5%. Dip time: 4 \pm 1 sec. Depth: completely cover the termination. 
Terminal strength (SMD) test	No visible mechanical damage.	With the component mounted on a PCB with the device to be tested, apply a 17.7 N (1.8 Kg) force to the side of a device being tested. This force shall be applied for 60 +1 seconds. Also the force shall be applied radually as not to apply a shock to the component being tested.

Packaging(Unit:mm)

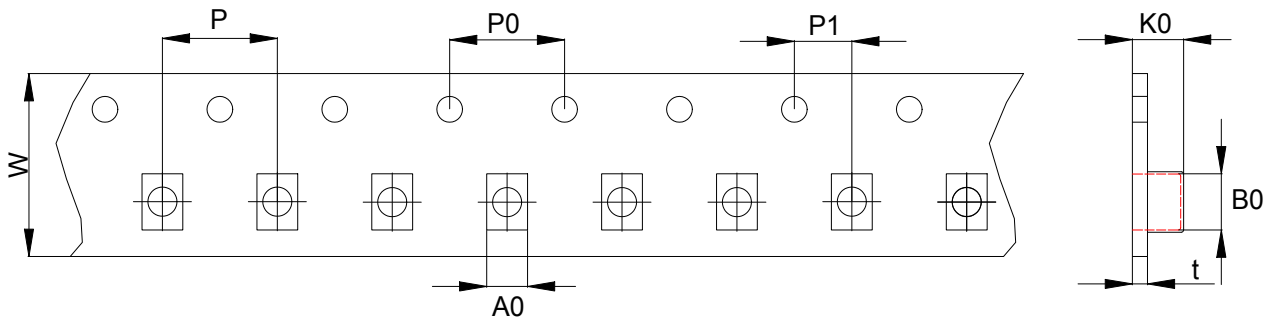

Type	W	P	P0	P1	A0	B0	K0	t
AACT322523	8.0 \pm 0.2	4.0 \pm 0.1	4.0 \pm 0.1	2.0 \pm 0.1	2.8 \pm 0.1	3.6 \pm 0.1	2.2 \pm 0.1	0.26 \pm 0.1
AACT453228	12.0 \pm 0.2	8.0 \pm 0.1	4.0 \pm 0.1	2.0 \pm 0.1	3.45 \pm 0.1	4.9 \pm 0.1	3.05 \pm 0.1	0.26 \pm 0.1

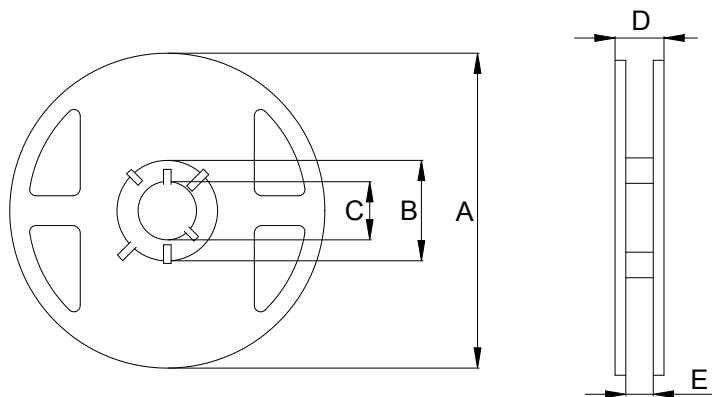

Type	A	B	C	D	E
AACT322523	178.0 \pm 2.0	60.0 \pm 2.0	13.5 \pm 2.0	13.0 \pm 2.0	9.0 \pm 2.0
AACT453228	178.0 \pm 2.0	60.0 \pm 2.0	13.5 \pm 2.0	17.5 \pm 2.0	13.5 \pm 2.0

Recommended Soldering Technologies

Re-flowing Profile:

- △ Preheat condition: 150~200°C/60~120sec.
- △ Allowed time above 217°C: 60~90sec.
- △ Max temp: 260°C
- △ Max time at max temp: 5sec.
- △ Solder paste: Sn/3.0Ag/0.5Cu
- △ Allowed Reflow time: 2x max

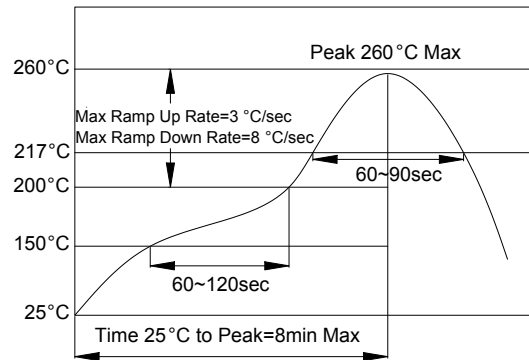

Iron Soldering Profile:

- △ Iron soldering power: Max.30W
- △ Pre-heating: 150°C/60sec.
- △ Soldering Tip temperature: 350°C Max.
- △ Soldering time: 3sec Max.
- △ Solder paste: Sn/3.0Ag/0.5Cu
- △ Max.1 times for iron soldering

[Note: Take care not to apply the tip of the soldering iron to the terminal electrodes.]

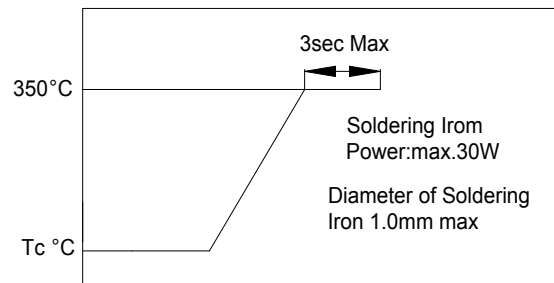

X-ON Electronics

Largest Supplier of Electrical and Electronic Components

Click to view similar products for [Common Mode Chokes / Filters](#) category:

Click to view products by [COILANK](#) manufacturer:

Other Similar products are found below :

[PE-64683](#) [RD5122-6-9M6](#) [RD6137-6-7M5](#) [RD8147-16-3M0](#) [ST6118T-R](#) [FE3X025-10-7NL](#) [RD7147-25-0M7](#) [TCM0806G-350-2P-T](#)
[TCM0806G-650-2P-T](#) [IND-0110](#) [UAL21VR0802000](#) [UALSC023000000](#) [UALSC1020JH000](#) [UALSU10VD20010](#) [UALSU9VD070100](#) [36-00037](#) [UALW21HS072450](#) [UALSU9H0208000](#) [UAL24VK06450CH](#) [PLT10HH501100PNB](#) [PLT10HH401100PNB](#) [PLT10HH1026R0PNB](#)
[36-00029-01](#) [PE-67531](#) [TLH10UB](#) [113 0R5](#) [2752045447](#) [7351V](#) [CMF16-153131](#) [RD7147-6-6M0](#) [T8116NLT](#) [FE2X10-4-2NL](#) [36-00029-07](#)
[T8003NLT](#) [CTX01-13663](#) [CTX66-19521-R](#) [RC212-0.5-10M](#) [RC112-0.4-15M](#) [RC212-0.6-6M8](#) [RC212-0.4-15M](#) [RC112-0.3-30M](#)
[WTCF2012Z0M751PB](#) [PH9408.814NLT](#) [PAC6006.364NLT](#) [PAC6006.444NLT](#) [PAC6006.204NLT](#) [PH9407.204NLT](#) [PAC6006.264NLT](#)
[PH9408.105NLT](#) [PH9408.494NLT](#) [PAC6006.104NLT](#)