

### 1. External Dimensions (Unit:m/m)

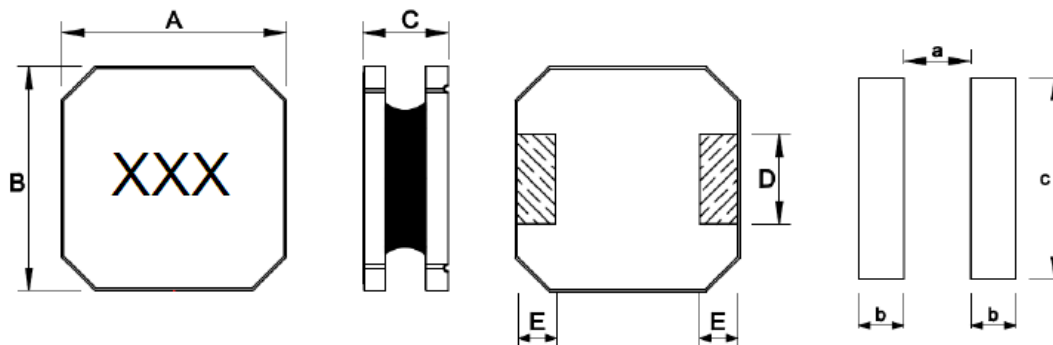

Type	A	B	C	D	E	a	b	c	Q'TY/Reel
ABG10A50	10.0±0.3	10.0±0.3	5.1Max	4.2Ref	1.7Ref	6.2Ref	2.0Ref	5.5Ref	700

### 2. Part Number Code

ABG    10    A    50    M    220  
 A        B        C        D        E        F

A: Series Name                      Power Inductors  
 B: Dimensions(mm)                10: 10.0x10.0  
 C: Materials                         NO use  
 D: Thickness(mm)                 50: 5.1 Max  
 E: Tolerance                         M: ±20%  
 F: Inductance                        220=22uH

### 3. Electrical Characteristics

Part Number	Inductance (μH)	Test Frequency (KHz)	DC Resistance (mΩ)±30%	Heat Rating Current I <sub>rms</sub> (A)	Saturation Current I <sub>sat</sub> (A)
ABG10A50M220	22.0	100KHz/1V	50.0	3.6	5.8

Notes:

- All test data is referenced to 25°C ambient.
- Operating Temperature Range-40°C to +125°C.
- I<sub>rms</sub> :DC current(A) that will cause an approximate ΔT of 40°C.
- I<sub>sat</sub> :DC current(A) that will cause L<sub>o</sub> to drop approximately 40%.
- The part temperature(ambient + temp rise)should not exceed 125°C under worst case operating conditions. Circuit design,component placement, PWB trace size and thickness,airflow and other cooling provisions all affect the part temperature, Part temperature should be verified in the end application.

### 4. Test Data

ELECTRICAL CHARACTERISTIC				MECHANICAL DIMENSIONS				
SPEC	L(uH)	DCR(mΩ)	Isat(uH)	A(mm)	B(mm)	C(mm)	D(mm)	
TOL	22.0	50.0	5.8A	10.0	10.0	5.1	4.2	
NO	±20%	±30%	(LOA-L5.8A) /LOA≤40%	±0.3	±0.3	Max	Ref	
1	20.59	49.27	14.79	10.04	9.98	4.99	OK	
2	20.62	48.82	14.43	9.97	10.01	5.04	OK	
3	20.47	50.24	14.76	10.01	10.02	5.05	OK	
4	20.34	49.85	14.65	10.02	9.98	4.97	OK	
5	21.05	50.36	15.22	10.04	9.97	5.05	OK	
6	20.24	51.28	14.07	9.98	10.03	4.98	OK	
7	21.10	49.71	15.16	9.98	10.01	5.05	OK	
8	20.82	51.19	14.67	10.02	10.00	4.97	OK	
9	21.27	48.83	15.43	10.00	9.99	4.99	OK	
10	20.64	49.20	14.55	10.01	10.01	5.04	OK	

Test Equipmets: IM3536,VR126,VR7210,Calipers

Curve:

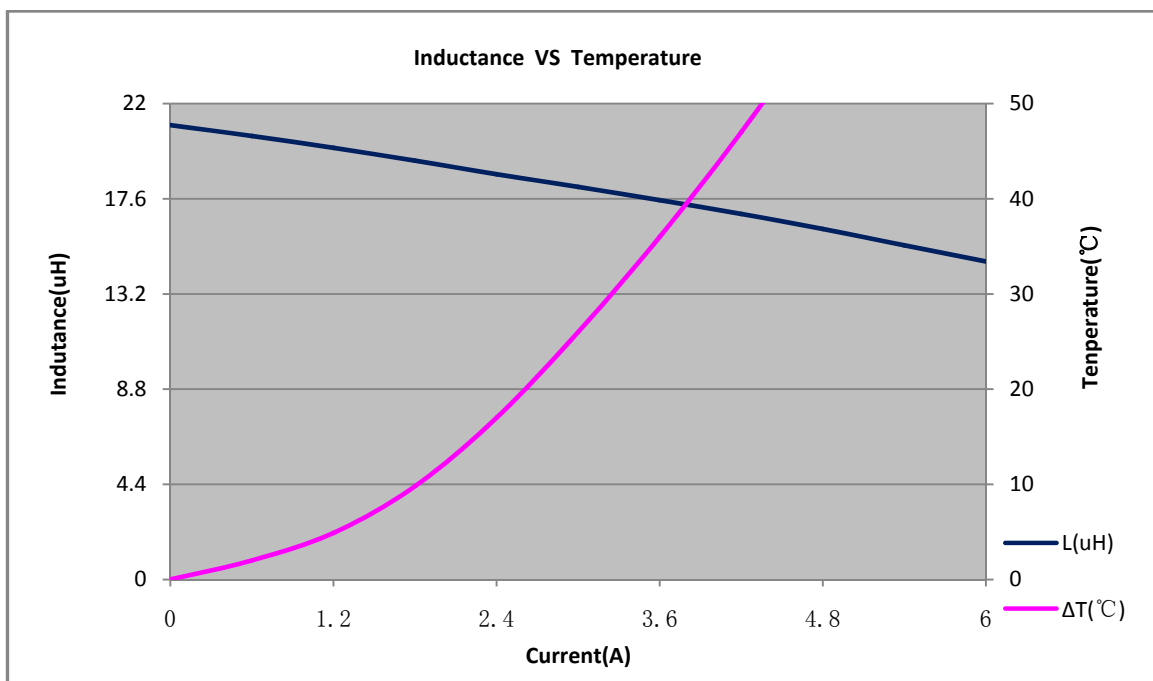

## 5. Test and Measurement Procedures

### 5.1 Test Conditions

5.1.1 Unless otherwise specified, the standard atmospheric conditions for measurement/test as:

- a. Ambient Temperature:  $20 \pm 15^\circ\text{C}$
- b. Relative Humidity:  $65\% \pm 20\%$
- c. Air Pressure: 86KPa to 106KPa

5.1.2 If any doubt on the results, measurements/tests should be made within the following limits:

- a. Ambient Temperature:  $20 \pm 2^\circ\text{C}$
- b. Relative Humidity:  $65\% \pm 5\%$
- c. Air Pressure: 86KPa to 106Kpa

### 5.2 Visual Examination

- a. Inspection Equipment: 10X magnifier

### 5.3 Electrical Test

5.3.1 Inductance (L)

- a. Refer to the third item.
- b. Test equipment: IM3536 LCR meter or equivalent.
- c. Test Frequency and Voltage: Refer to the third item.

5.3.2 Direct Current Resistance (DCR)

- a. Refer to the third item.
- b. Test equipment: VR126 or equivalent.

5.3.3 Saturation Current ( $I_{\text{sat}}$ )

- a. Refer to the third item.
- b. Test equipment: Saturation current meter
- c. Definition of saturation current ( $I_{\text{sat}}$ ): DC current at which the inductance drops approximate 40% from its value without current.

5.3.4 Temperature rise current ( $I_{\text{rms}}$ )

- a. Refer to the third item.
- b. Test equipment (see Fig.5.3.4-1): Electric Power, Electric current meter, Thermometer.
- c. Measurement method (see Fig. 5.3.4-1):
  1. Set test current to be 0mA.
  2. Measure initial temperature of choke surface.
  3. Gradually increase current and measure choke temperature for corresponding current.
  4. Definition of Temperature rise current: DC current that causes the temperature rise ( $\Delta T = 40^\circ\text{C}$ ) from  $20^\circ\text{C}$  ambient (see Fig. 5.3.4-2).

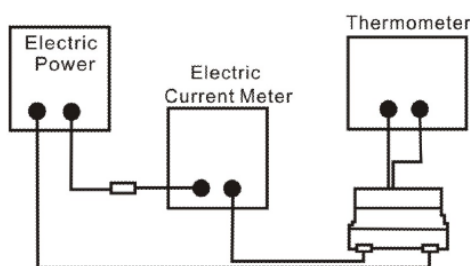

Fig.5.3.4-1

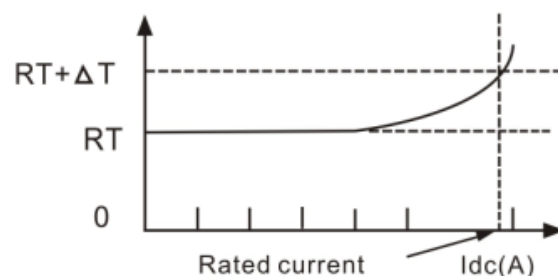
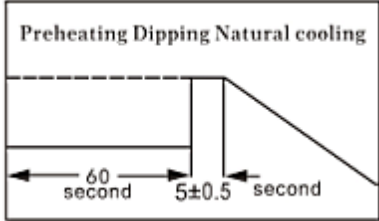
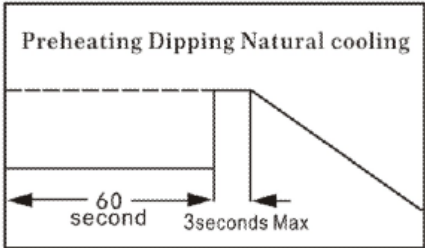
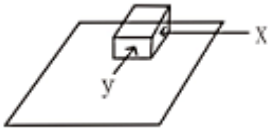
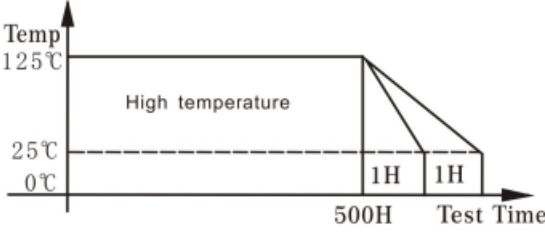
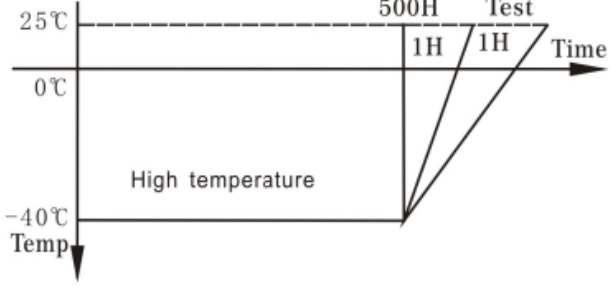
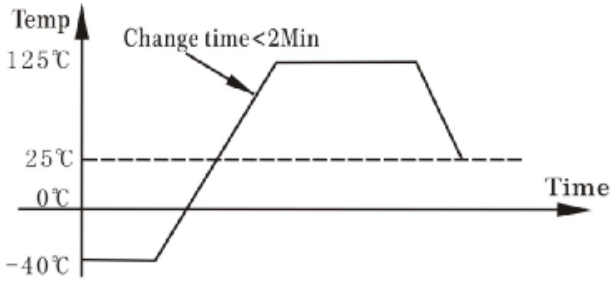

Fig.5.3.4-2

### 5.4 Reliability Test

Items	Required Characteristics	Test Method/Condition
<p>5.4.1 Solder Ability Test</p>	<p>① 90% or more of electrode area shall be Coated by new solder.</p>	<p>① After fluxing, component shall be dipped in a melted. ② Solder: bath at <math>235^{\circ}\text{C} \pm 5^{\circ}\text{C}</math> for <math>5 \pm 0.5</math> seconds</p> 
<p>5.4.2 Heat endurance of Soldering</p>	<p>① No visible mechanical damage. ② Inductance change: Within <math>\pm 10\%</math> ③ Impedance change: Within <math>\pm 10\%</math></p>	<p>① Preheat: <math>150 \pm 5^{\circ}\text{C}</math> 60seconds. ② Solder temperature: <math>255 \pm 5^{\circ}\text{C}</math>. ③ Flux: rosin. ④ Dip time: 3seconds Max</p> 
<p>5.4.3 Electrode Strength Test</p>	<p>① After soldering of X, Y withstanding at below conditions .The terminal should not Peel off.</p>	<p>① Specimen shall be soldered on a PCB and a static force of 17.7N shall be applied on the coil from X, Y directions individually and held for <math>10 \pm 2\text{S}</math></p> 
<p>5.4.4 Vibration Test</p>	<p>① Inductance change: Within <math>\pm 10\%</math> ② Without mechanical damage such as Break</p>	<p>① Vibration frequency: (10 Hz to 55 Hz to 10Hz) in 60 seconds as a period ② Vibration time: Period cycled for 2 hours in each of 3 mutual perpendicular directions. ③ Amplitude: 1.5 mm max.</p>
<p>5.4.5 Drop test</p>	<p>① <math>\Delta L \leq \pm 10.0\%</math> change from an initial value</p>	<p>① Drop specimen three times on concrete floor from a height Of 1 meter which mounted on test board.</p>

Items	Required Characteristics	Test Method/Condition
<p>5.4.6 High Temperature Storage Test</p>	<p>① No case deformation or change in appearance            ② <math>\Delta L/L \leq 10\%</math>            ③ <math>\Delta Q/Q \leq 30\%</math>            ④ <math>\Delta DCR/DCR \leq 10\%</math></p>	<p>① Temperature: <math>125^{\circ}\text{C} \pm 5^{\circ}\text{C}</math> Time: <math>500 \pm 2</math> hours.            ② Tested not less than 1 hour, nor more than 2 hours at room.</p> 
<p>5.4.7 Low Temperature Storage Test</p>	<p>① No case deformation or change in appearance            ② <math>\Delta L/L \leq 10\%</math>            ③ <math>\Delta Q/Q \leq 30\%</math>            ④ <math>\Delta DCR/DCR \leq 10\%</math></p>	<p>① Temperature: <math>-40^{\circ}\text{C} \pm 2^{\circ}\text{C}</math> Time: <math>500 \pm 2</math> hours.            ② Tested not less than 1 hour, nor more than 2 hours at room.</p> 
<p>5.4.8 Humidity Resistance Test</p>	<p>① No case deformation or change in appearance            ② <math>\Delta L/L \leq 10\%</math>            ③ <math>\Delta Q/Q \leq 30\%</math>            ④ <math>\Delta DCR/DCR \leq 10\%</math></p>	<p>① Environment condition: <math>85 \pm 2^{\circ}\text{C}</math>            ② Humidity: 80–85%            ③ Applied Current: Rated current            ④ Duration: <math>500 + 4 / -0</math> hours            ⑤ Tested not less than 1 hour, nor more than 2 hours at room.</p>
<p>5.4.9 Thermal Shock Test</p>	<p>① No case deformation or change in appearance.            ② <math>\Delta L/L \leq 10\%</math>            ③ <math>\Delta Q/Q \leq 30\%</math>            ④ <math>\Delta DCR/DCR \leq 10\%</math></p>	<p>① Repeat 100 cycles as follow:            (<math>-40 \pm 3^{\circ}\text{C}</math>; <math>30 \pm 3</math> min)            → (Room temp; 2 min)            → (<math>+125 \pm 2^{\circ}\text{C}</math>, <math>30 \pm 3</math> min)            → (Room temp; 2 min)            ② Recovery: 1-2 hours of recovery under the standard condition after the test.</p> 

### 6. Packaging, Storage

#### 6.1 Tape and Reel Packaging Dimensions

6.1.1 Taping Dimensions (Unit: mm)

Please refer to Fig. 6.1.1-1

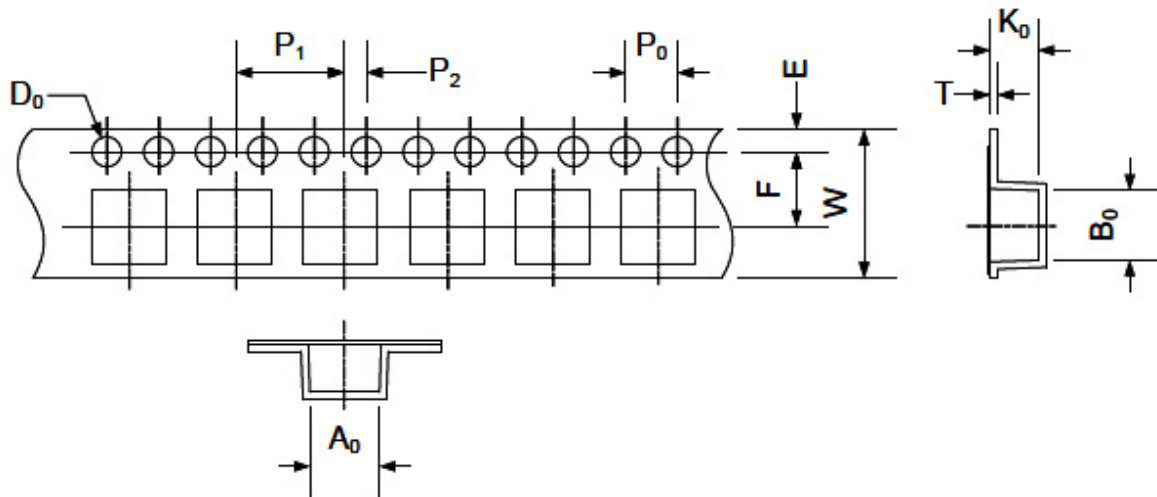

Fig. 6.1.1-1

TYPE	A0	B0	W	E	F	P0	P1	P2	D0	T	K0
ABG10A50	10.35±0.1	10.35±0.1	24.0±0.3	1.75±0.1	11.5±0.1	4.0±0.1	16.0±0.1	2.0±0.1	1.5±0.1	0.4±0.1	5.3±0.1

6.1.2 Direction of rolling

Please refer to Fig. 6.1.2-1.

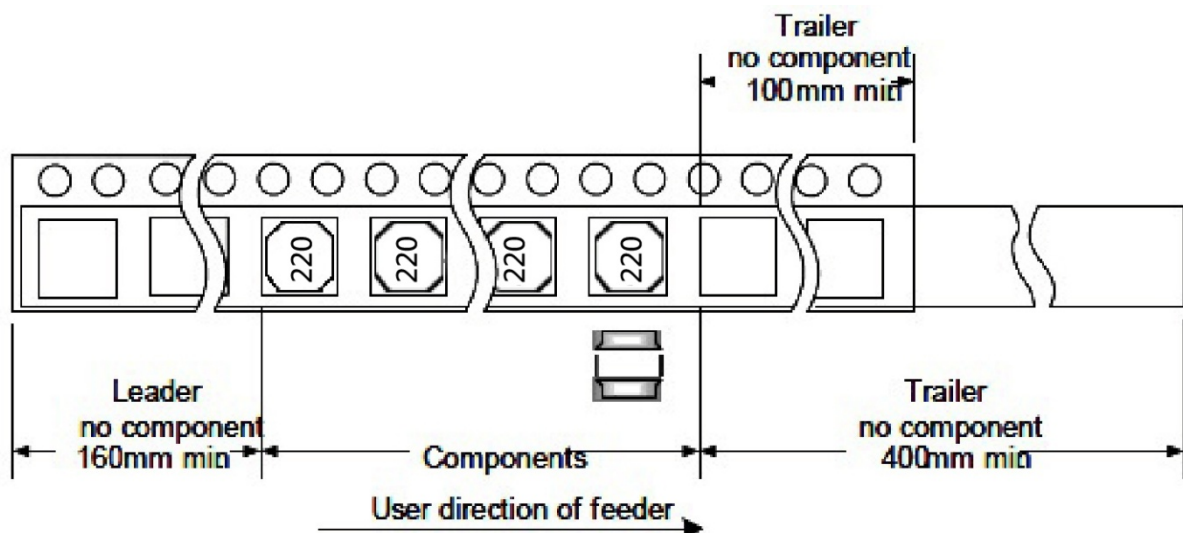

Fig. 6.1.2-1.

### 6.1.3 Reel Dimensions (Unit: mm)

Please refer to Fig. 6.1.3-1.

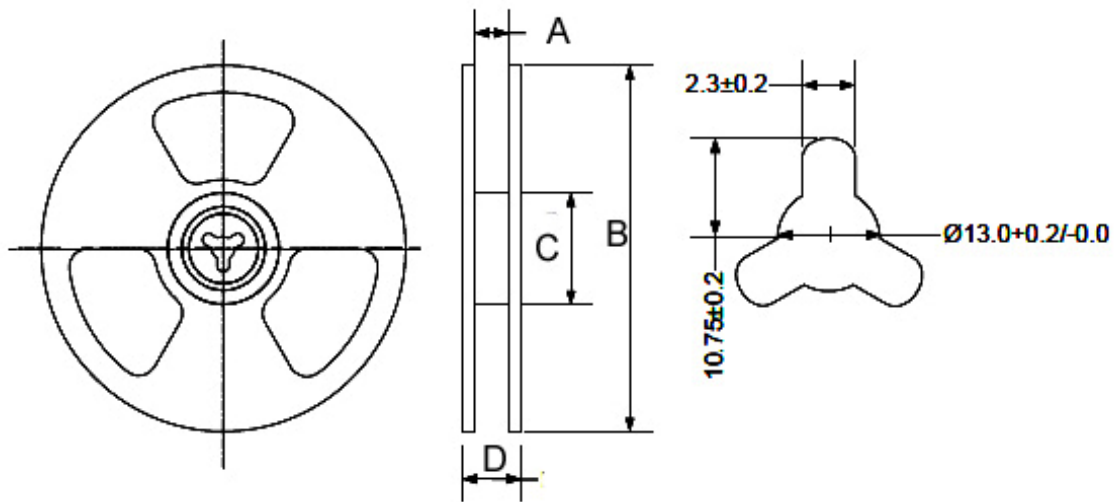

Fig. 6.1.3-1.

TYPE	A	B	C	D
ABG10A50	24.5±2.0	330.0±2.0	100.0±2.0	28.5±2.0

## 6.2 Packaging

6.2.1 The inner box specification: 350\*340\*40MM

Packing quantity: 700PCS/ box

Bubble bag : 37\*45CM

Job description: putting the air bubble bag products placed inside the box, sealed with scotch tape

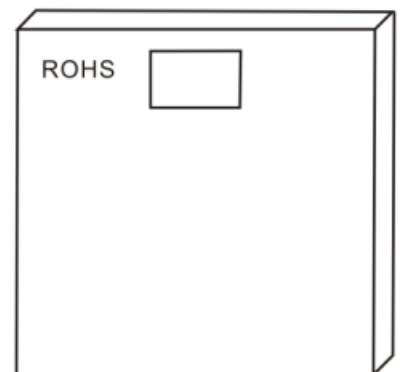

6.2.2 The outside box specification: 370\*360\*255MM

Packing quantity: 2100PCS/ box

Job description: will be outside the box bottom sealed, inner box into the box.

a. With transparent tape sealed box at the top

b. The specified location with a box labels in the outer box.

c. If the mantissa box under a FCL with inner box or filling full

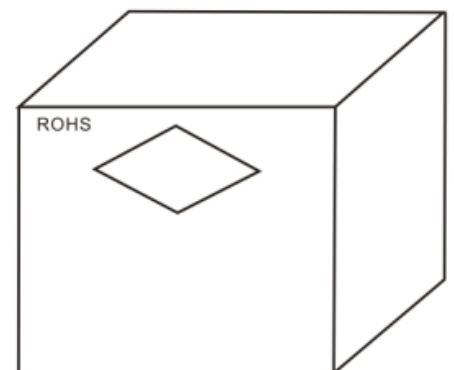

### 6.3 Storage

- To maintain the solderability of terminal electrodes and to keep the packing material in good condition, temperature and humidity in the storage area should be controlled.
- Recommended conditions:  $-10^{\circ}\text{C}\sim 40^{\circ}\text{C}$ , 70%RH (Max.)
- The ambient temperature must be kept below  $30^{\circ}\text{C}$ . Even under ideal storage conditions, solderability of products electrodes may decrease as time passes. For this reason, product should be used with one year from the time of delivery.
- In case of storage over 6 months, solderability shall be checked before actual usage.

## 7. Recommended Soldering Technologies

### 7.1 Re-flowing Profile:

- △ 1~2 °C/sec. Ramp
- △ Pre-heating:  $150\sim 190^{\circ}\text{C}/90\pm 30\text{sec}$ .
- △ Time above  $240^{\circ}\text{C}$ : 20~40sec
- △ Peak temperature:  $255^{\circ}\text{C}$  Max./5sec;
- △ Solder paste: Sn/3.0Ag/0.5Cu
- △ Max.2 times for Re-flowing

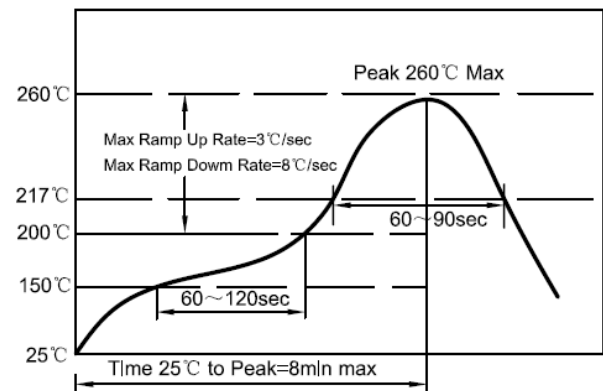

### 7.2 Iron Soldering Profile:

- △ Iron soldering power: Max.30W
- △ Pre-heating:  $150^{\circ}\text{C}/60\text{sec}$ .
- △ Soldering Tip temperature:  $350^{\circ}\text{C}$  Max.
- △ Soldering time: 3sec Max.
- △ Solder paste: Sn/3.0Ag/0.5Cu
- △ Max.1 times for iron soldering

[Note: Take care not to apply the tip of the soldering iron to the]

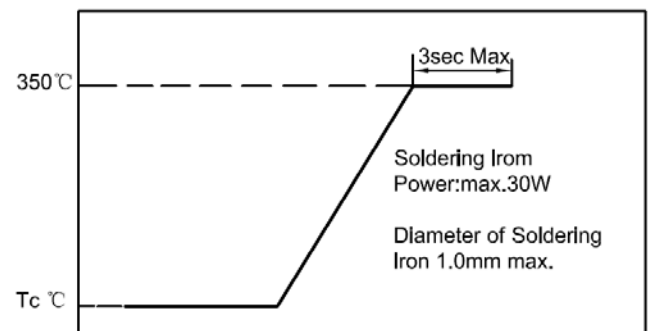



## X-ON Electronics

Largest Supplier of Electrical and Electronic Components

*Click to view similar products for [Fixed Inductors](#) category:*

*Click to view products by [COILANK](#) manufacturer:*

Other Similar products are found below :

[CR32NP-100KC](#) [CR32NP-151KC](#) [CR32NP-180KC](#) [CR32NP-181KC](#) [CR32NP-1R5MC](#) [CR32NP-390KC](#) [CR32NP-3R9MC](#) [CR32NP-680KC](#) [CR32NP-820KC](#) [CR32NP-8R2MC](#) [CR43NP-390KC](#) [CR43NP-560KC](#) [CR43NP-680KC](#) [CR54NP-181KC](#) [CR54NP-470LC](#) [CR54NP-820KC](#) [CR54NP-8R5MC](#) [70F224AI](#) [MGDQ4-00004-P](#) [MHL1ECTTP18NJ](#) [MHQ1005P10NJ](#) [MHQ1005P1N0S](#) [MHQ1005P2N4S](#) [MHQ1005P3N6S](#) [MHQ1005P5N1S](#) [MHQ1005P8N2J](#) [PE-51506NL](#) [PE-53601NL](#) [PE-53602NL](#) [PE-53630NL](#) [PE-53824SNLT](#) [PE-92100NL](#) [PG0434.801NLT](#) [PG0936.113NLT](#) [9220-20](#) [9310-16](#) [PM06-2N7](#) [PM06-39NJ](#) [A01TK](#) [1206CS-471XJ](#) [HC2LP-R47-R](#) [HC2-R47-R](#) [HC3-2R2-R](#) [HCF1305-3R3-R](#) [1206CS-151XG](#) [RCH664NP-140L](#) [RCH664NP-4R7M](#) [RCH8011NP-221L](#) [RCP1317NP-332L](#) [RCP1317NP-391L](#)