

# USB 2.0 Common Mode Choke 0805

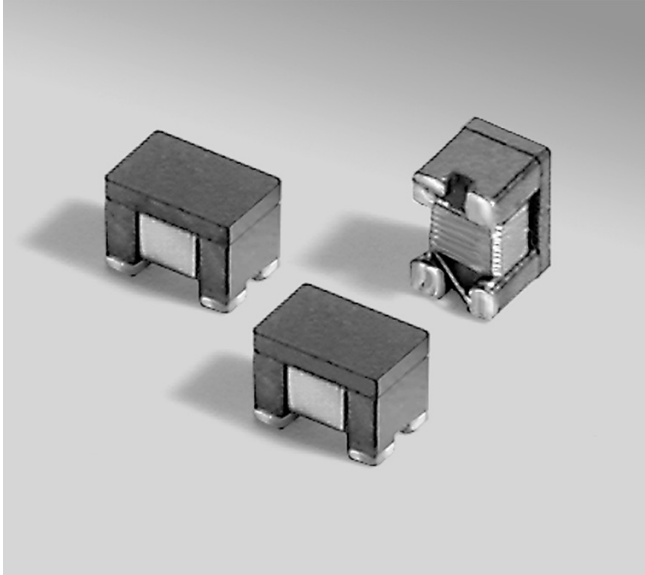

- For common mode noise suppression in high speed differential signal lines: USB2.0, IEEE1394, LVDS, etc.
- Up to 3.4 GHz differential mode 3 dB cutoff frequency
- Up to 2 kOhms common mode peak impedance
- Over 35 dB common mode noise attenuation

**Designer's Kit C470** contains 10 each of all 0603USB, 0805USB, 0805USBF, 0805USBN and 1206USB parts

**Core material** Ferrite

**Environmental** RoHS compliant, halogen free

**Terminations** Gold over nickel over silver-palladium-glass frit.

**Ambient temperature** -40°C to +85°C with Irms current

**Maximum part temperature** 105°C (ambient + temp rise)

**Storage temperature** Component: -40°C to +105°C.

Tape and reel packaging: -40°C to +80°C

**Resistance to soldering heat** Max three 40 second reflows at +260°C, parts cooled to room temperature between cycles

**Moisture Sensitivity Level (MSL)** 1 (unlimited floor life at <30°C / 85% relative humidity)

**PCB washing** Tested to MIL-STD-202 Method 215 plus an additional aqueous wash. See [Doc787\\_PCB\\_Washing.pdf](#).

Part number <sup>1</sup>	Common mode peak impedance (kOhms)	Cutoff frequency <sup>2</sup> (GHz)	Common mode attenuation typ (dB)			Inductance <sup>3</sup> min (nH)	DCR max <sup>4</sup> (Ohms)	Isolation <sup>5</sup> (Vrms)	Irms <sup>6</sup> (mA)
			10 MHz	100 MHz	500 MHz				
0805USB-421ML_	>0.22 @ >3.0 GHz	3.5	1.1	2.3	8.4	23	0.12	250	500
0805USB-901ML_	>0.29 @ >3.0 GHz	2.5	1.4	4.2	16.9	47	0.17	250	500
0805USB-172ML_	0.64 @ 1.8 GHz	1.8	2.3	6.7	22.0	84	0.25	250	500
0805USB-262ML_	0.82 @ 1.8 GHz	1.5	3.0	8.6	27.8	147	0.26	250	500
0805USB-372ML_	1.06 @ 1.4 GHz	0.82	4.5	11.9	34.3	189	0.32	250	500
0805USB-502ML_	1.42 @ 1.1 GHz	0.70	4.9	14.5	31.3	273	0.37	250	500
0805USB-672ML_	1.75 @ 0.93 GHz	0.46	8.4	16.6	30.0	322	0.45	250	500
0805USB-902ML_	2.06 @ 0.81 GHz	0.47	8.7	18.7	30.5	413	0.65	250	400

1. When ordering, please specify **packaging** code:

### 0805USB-902MLC

**Packaging: C** = 7" machine-ready reel. EIA-481 embossed plastic tape (2000 parts per full reel). Quantities less than full reel available: in tape (not machine ready) or with leader and trailer (\$25 charge).

**B** = Less than full reel. In an effort to simplify our part numbering system, Coilcraft is eliminating the need for multiple packaging codes. When ordering, simply change the last letter of your part number from B to C.

**D** = 13" machine-ready reel. EIA-481 embossed plastic tape (7500 parts per full reel).

2. Frequency at which the differential mode attenuation equals -3 dB

3. Inductance measured at 100 MHz using an Agilent/HP 4286A impedance analyzer and a Coilcraft SMD-A fixture.

4. DCR is specified per winding.

5. Winding to winding isolation (hipot) tested for one minute.

6. Current per winding that causes a 20°C rise from 25°C ambient.

7. Electrical specifications at 25°C.

Refer to Doc 362 "Soldering Surface Mount Components" before soldering.

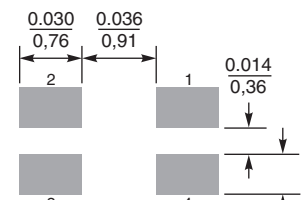
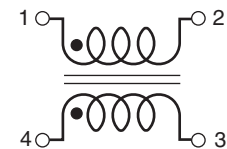
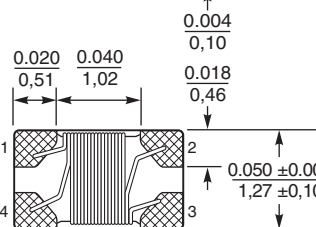
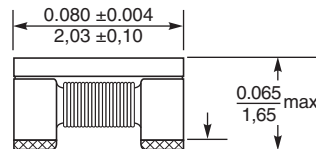

Dimensions are in  $\frac{\text{inches}}{\text{mm}}$

**Recommended Land Pattern**

**Weight** 14.9 – 15.2 mg

**Packaging** 2000/7" reel; 7500/13" reel; Plastic tape: 8 mm wide, 0.23 mm thick, 4 mm pocket spacing, 1.5 mm pocket depth



# USB 2.0 Common Mode Filter – 0805

Typical Attenuation (Ref: 50 Ohms)

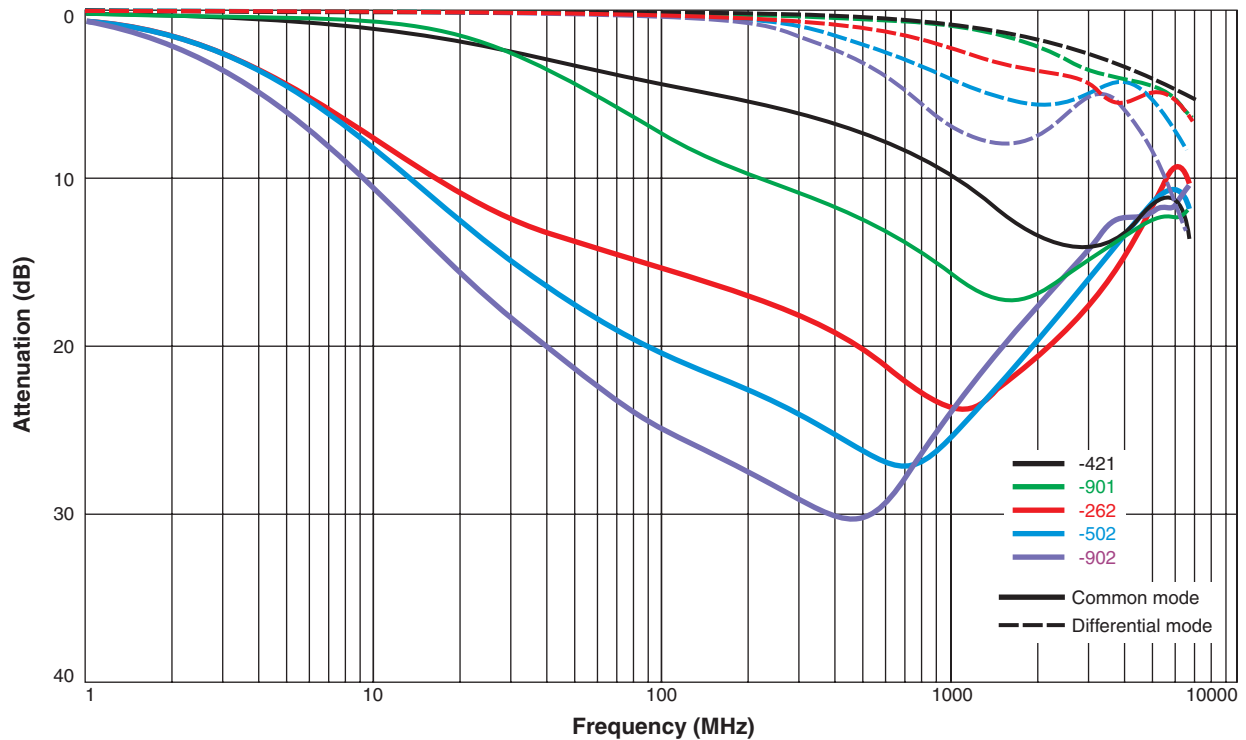

## Typical Impedance vs Frequency

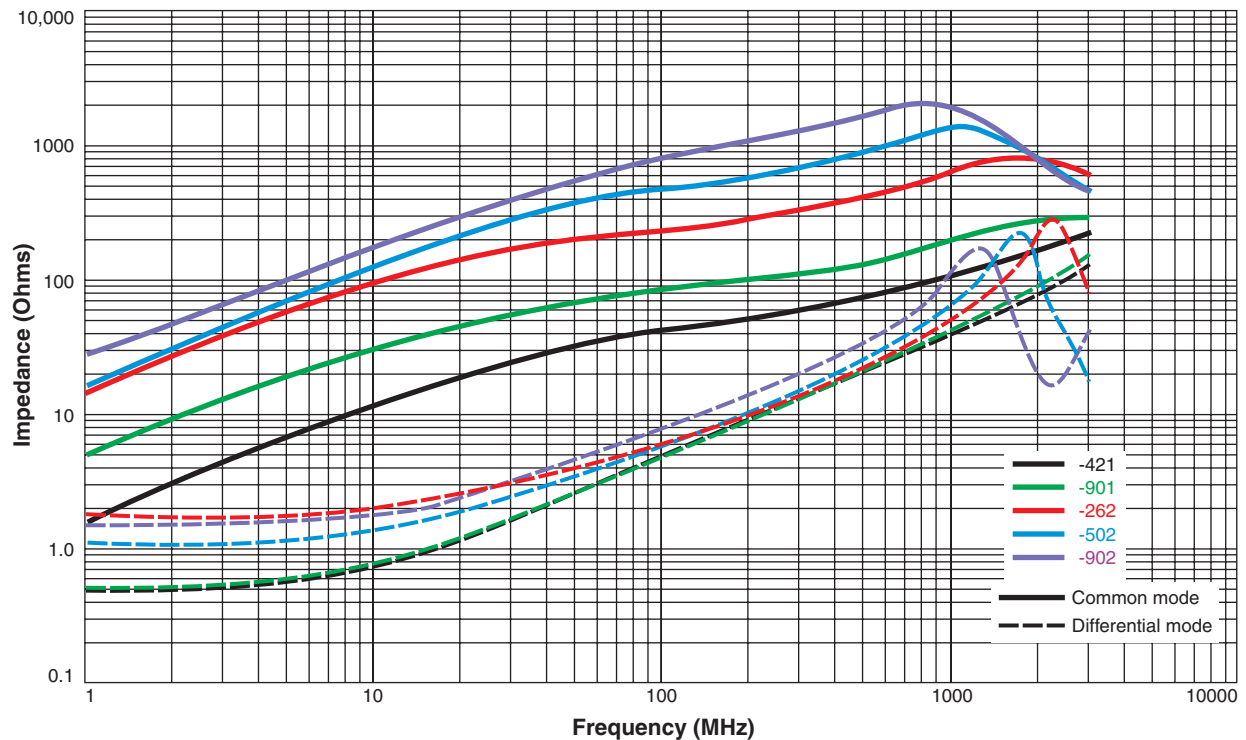

**US** +1-847-639-6400 sales@coilcraft.com  
**UK** +44-1236-730595 sales@coilcraft-europe.com  
**Taiwan** +886-2-2264 3646 sales@coilcraft.com.tw  
**China** +86-21-6218 8074 sales@coilcraft.com.cn  
**Singapore** + 65-6484 8412 sales@coilcraft.com.sg

Document 306-2 Revised 12/01/21  
 © Coilcraft Inc. 2021  
 This product may not be used in medical or high risk applications without prior Coilcraft approval. Specification subject to change without notice. Please check web site for latest information.

## X-ON Electronics

Largest Supplier of Electrical and Electronic Components

*Click to view similar products for [Common Mode Chokes / Filters](#) category:*

*Click to view products by [Coilcraft](#) manufacturer:*

Other Similar products are found below :

[74279408](#) [PE-62911NL](#) [PE-64683](#) [ST6118T-R](#) [T8114NLT](#) [RD5122-10-6M0](#) [TCM0806G-350-2P-T](#) [TCM0806G-650-2P-T](#) [IND-0110](#)  
[UAL21V07012500](#) [UAL21VR0802000](#) [UAL24VR06500CH](#) [UALSC023000000](#) [UALSC1020JH000](#) [UALSC1520JH000](#)  
[UALSU16VD30030](#) [UALSU16VD40010](#) [UALSU9H0305000](#) [UALSU9HF060300](#) [UALSU9VD070100](#) [36-00037](#) [5701610000](#)  
[UALW21HS072450](#) [UALSU9VD070400](#) [UALSU9HF050500](#) [UALSU9H0208000](#) [UALSCF25081300](#) [UAL24VK06450CH](#)  
[PLT10HH501100PNB](#) [PLT10HH401100PNB](#) [PLT10HH1026R0PNB](#) [PE-67531](#) [EXC-X4CH120X](#) [TLH10UB 113 0R5](#) [2752041447](#)  
[2752045447](#) [CMS3-11-R](#) [7351V](#) [CMF16-153131](#) [744252510](#) [T8116NLT](#) [FE2X10-4-2NL](#) [744253200](#) [744253101](#) [744252220](#) [TX8111NLT](#)  
[UAL30VR3500470](#) [CTX01-19077-R](#) [T8003NLT](#) [CTX01-13663](#)