

Power Injection Chokes for PoC 1210POC



- Optimized for AEC-Q200 power over coax (PoC) applications
- Small size to reduce board area of overall system solutions
- High impedance ($\geq 1\text{k}\Omega$) maintained over a wide band frequency range to isolate AC signal from the DC power
- AEC-Q200 Grade 1 (-40°C to $+125^\circ\text{C}$)

Core material Ferrite

Environmental RoHS compliant, halogen free

Terminations RoHS compliant matte tin over nickel over silver-platinum-glass frit.

Weight 115 – 125 mg

Ambient temperature -40°C to $+125^\circ\text{C}$ with (15°C rise) Irms current.

Maximum part temperature $+140^\circ\text{C}$ (ambient + temp rise).

Storage temperature Component: -40°C to $+140^\circ\text{C}$.

Tape and reel packaging: -40°C to $+80^\circ\text{C}$

Resistance to soldering heat Max three 40 second reflows at $+260^\circ\text{C}$, parts cooled to room temperature between cycles

Moisture Sensitivity Level (MSL) 1 (unlimited floor life at $<30^\circ\text{C}$ / 85% relative humidity)

Packaging 750/7" reel; 3000/13" reel; Plastic tape: 12 mm wide, 0.25 mm thick, 8 mm pocket spacing, 2.72 mm pocket dept

PCB washing Tested to MIL-STD-202 Method 215 plus an additional aqueous wash. See [Doc787_PCB_Washing.pdf](#).

Part number ¹	L ² ±20% (μH)	DCR (Ohms) ³		SRF typ ⁴ (MHz)	Isat (mA) ⁵					Irms typ (mA)		
		typ	max		25°C	85°C	105°C	125°C	140°C	at 25°C ⁶	at 85°C ⁷	at 125°C ⁸
1210POC-222MR_	2.2	0.10	0.13	300	2200	1900	1700	1500	1300	1900	1730	1000
1210POC-472MR_	4.7	0.16	0.19	160	1600	1300	1100	950	810	1500	1350	850
1210POC-682MR_	6.8	0.20	0.24	120	1400	1000	930	800	700	1360	1230	800
1210POC-103MR_	10	0.29	0.34	95	1100	850	760	660	560	1130	1020	570
1210POC-153MR_	15	0.43	0.51	81	910	740	660	580	510	900	840	500
1210POC-183MR_	18	0.74	0.84	79	810	660	580	510	450	850	800	450
1210POC-223MR_	22	0.76	0.88	70	720	580	520	450	390	700	630	400

1. When ordering, please specify **packaging** code:

1210POC-223MRC

Packaging: C = 7" machine-ready reel. EIA-481 embossed plastic tape (750 parts per full reel). Quantities less than full reel available: in tape (not machine ready) or with leader and trailer (\$25 charge).

D = 13" machine-ready reel. EIA-481 embossed plastic tape (3000 parts per full reel). Factory order only, not stocked.

2. Inductance tested at 100 kHz, 0.1 Vrms, 200 mA DC using HP4263 with SMD-B test fixture or equivalent

3. DCR measured using a micro-ohmmeter.

4. SRF measured using an Agilent/HP 5071C network analyzer and a Coilcraft SMD-D test fixture.

5. DC current that causes 30% inductance drop from its initial value at 200 mA at specified temperature.

6. Current that causes a 40°C rise at 25°C.

7. Current that causes a 40°C rise at 85°C.

8. Current that causes a 15°C rise at 125°C.

9. Electrical specifications at 25°C.

Refer to Doc 362 "Soldering Surface Mount Components" before soldering.

Dimensions – 1210POC

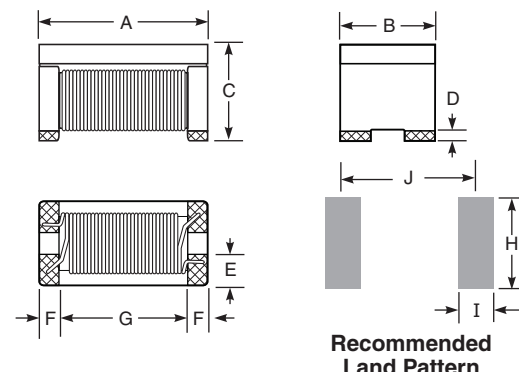

A	B	C	D	E	F	G	H	I	J	
max	max	max								in
0.13	0.105	0.118	0.004	0.037	0.020	0.080	0.104	0.026	0.100	
3,30	2,67	3,00	0,10	0,94	0,51	2,03	2,65	0,65	2,54	mm



1210POC Power Injection Chokes for PoC

L vs Current

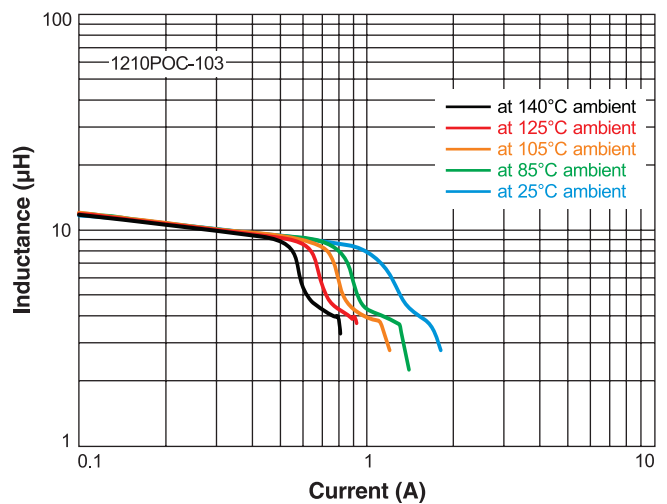
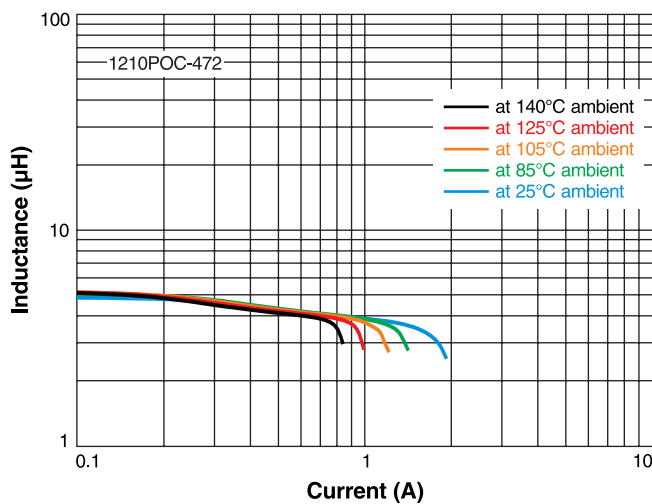
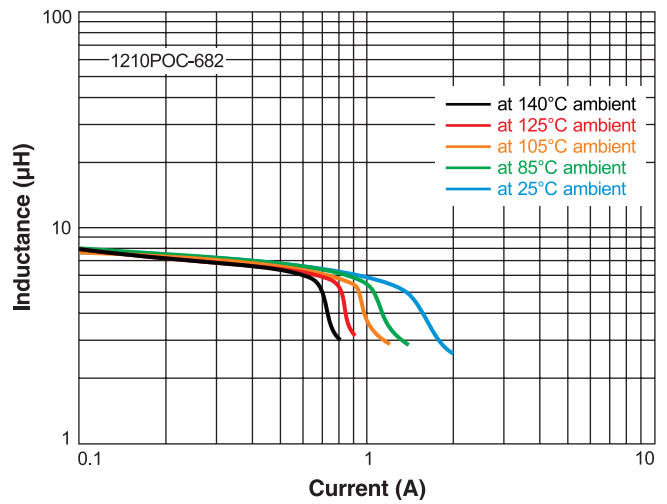
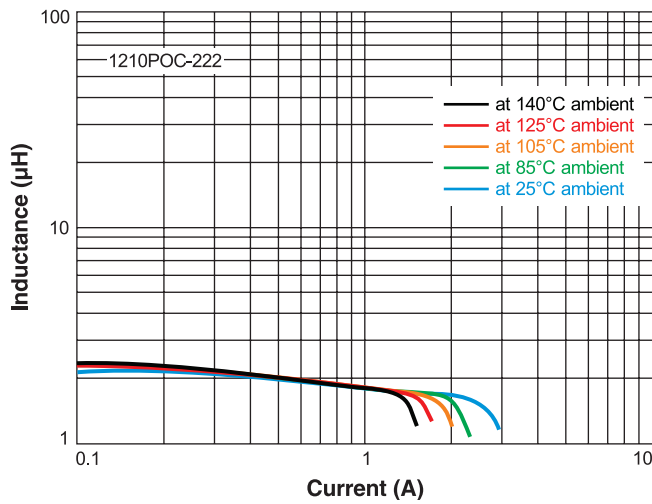

US +1-847-639-6400 sales@coilcraft.com
UK +44-1236-730595 sales@coilcraft-europe.com
Taiwan +886-2-2264 3646 sales@coilcraft.com.tw
China +86-21-6218 8074 sales@coilcraft.com.cn
Singapore + 65-6484 8412 sales@coilcraft.com.sg

Document 1585-2 Revised 12/22/21
 © Coilcraft Inc. 2022
 This product may not be used in medical or high risk applications without prior Coilcraft approval. Specification subject to change without notice. Please check web site for latest information.



1210POC Power Injection Chokes for PoC

L vs Current

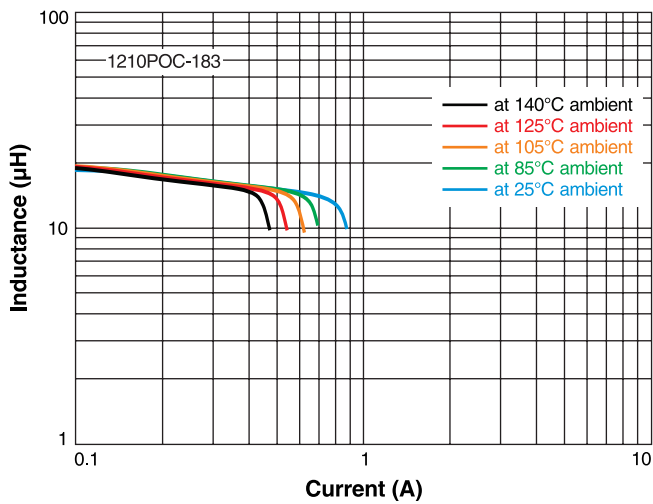
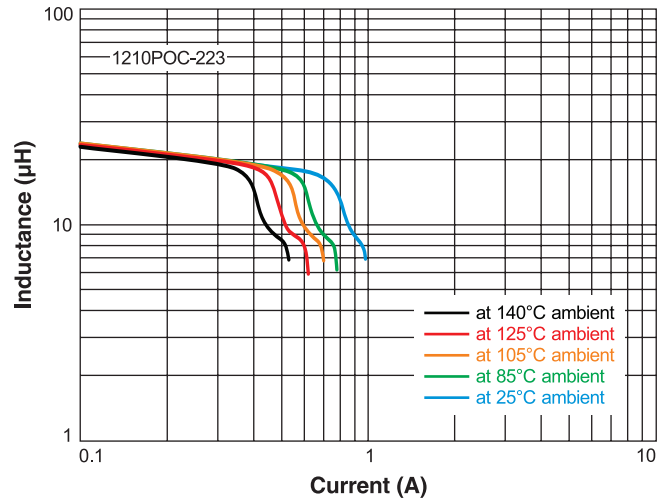
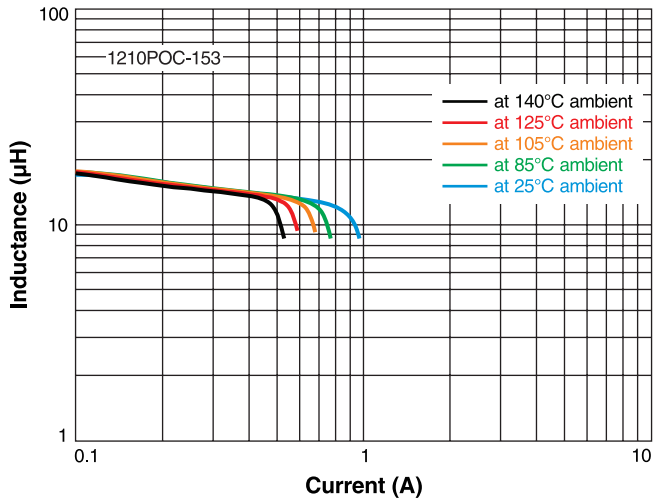

US +1-847-639-6400 sales@coilcraft.com
UK +44-1236-730595 sales@coilcraft-europe.com
Taiwan +886-2-2264 3646 sales@coilcraft.com.tw
China +86-21-6218 8074 sales@coilcraft.com.cn
Singapore + 65-6484 8412 sales@coilcraft.com.sg

Document 1585-3 Revised 12/22/21
 © Coilcraft Inc. 2022
 This product may not be used in medical or high risk applications without prior Coilcraft approval. Specification subject to change without notice. Please check web site for latest information.



1210POC Power Injection Chokes for PoC

Impedance vs Frequency

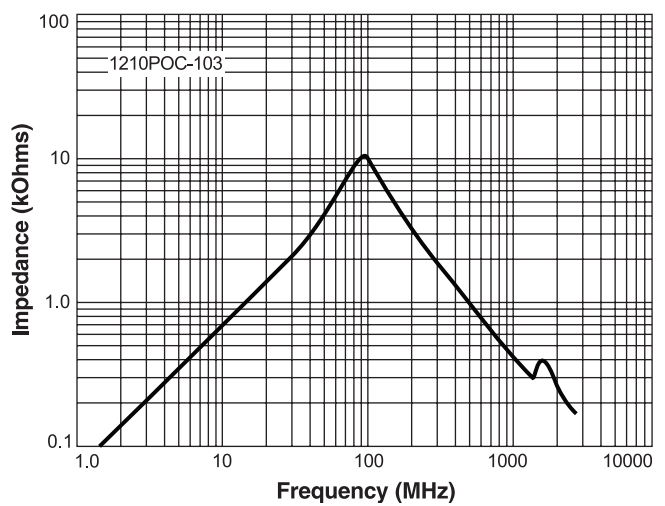
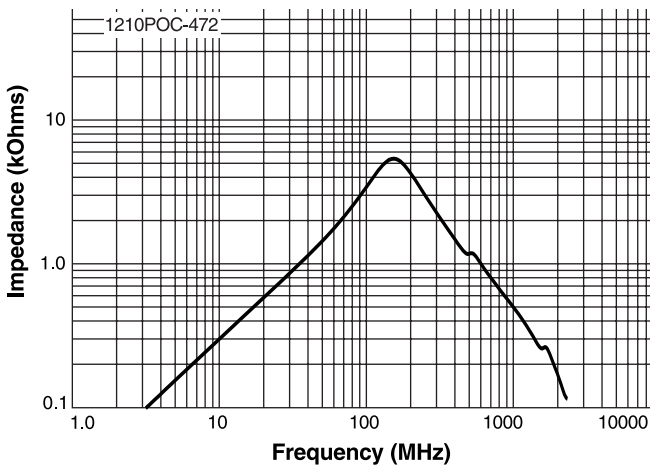
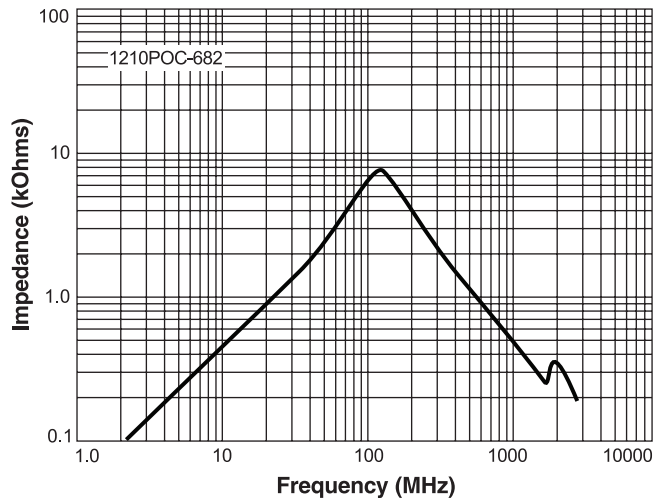
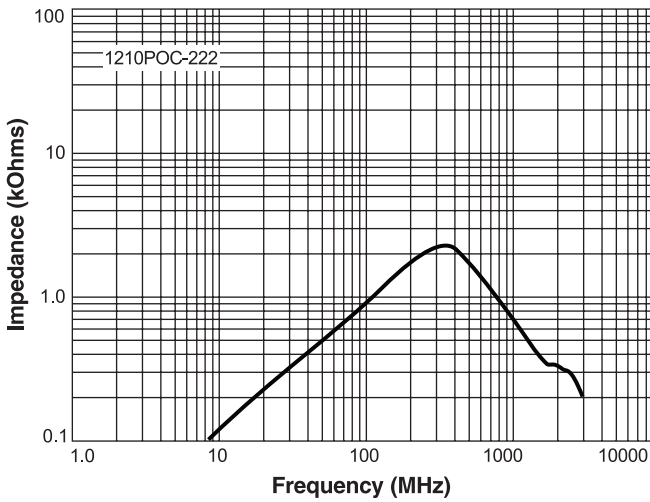

US +1-847-639-6400 sales@coilcraft.com
UK +44-1236-730595 sales@coilcraft-europe.com
Taiwan +886-2-2264 3646 sales@coilcraft.com.tw
China +86-21-6218 8074 sales@coilcraft.com.cn
Singapore + 65-6484 8412 sales@coilcraft.com.sg

Document 1585-4 Revised 12/22/21
 © Coilcraft Inc. 2022
 This product may not be used in medical or high risk applications without prior Coilcraft approval. Specification subject to change without notice. Please check web site for latest information.



1210POC Power Injection Chokes for PoC

Impedance vs Frequency

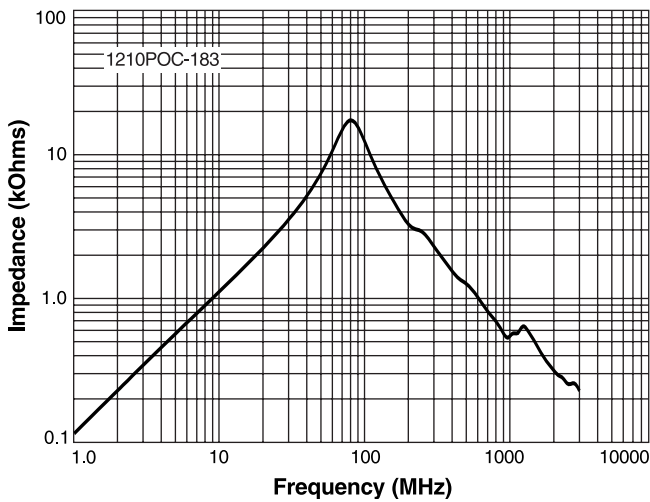
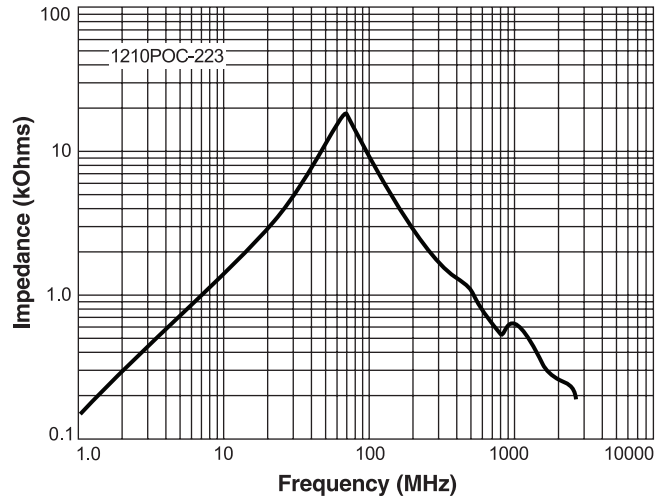
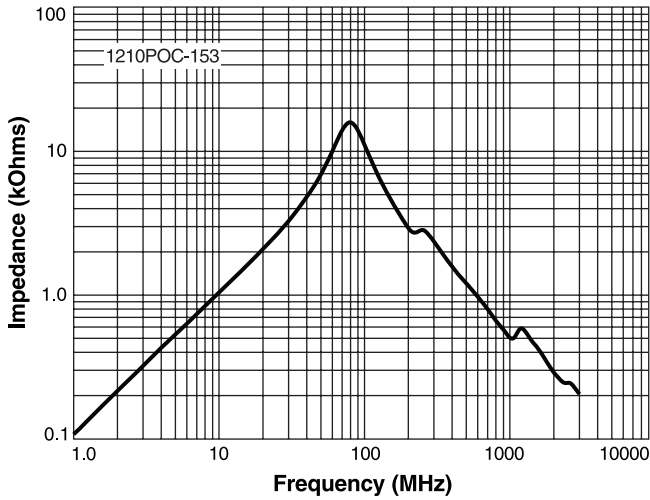

US +1-847-639-6400 sales@coilcraft.com
UK +44-1236-730595 sales@coilcraft-europe.com
Taiwan +886-2-2264 3646 sales@coilcraft.com.tw
China +86-21-6218 8074 sales@coilcraft.com.cn
Singapore + 65-6484 8412 sales@coilcraft.com.sg

Document 1585-5 Revised 12/22/21
 © Coilcraft Inc. 2022
 This product may not be used in medical or high risk applications without prior Coilcraft approval. Specification subject to change without notice. Please check web site for latest information.

X-ON Electronics

Largest Supplier of Electrical and Electronic Components

Click to view similar products for [Fixed Inductors](#) category:

Click to view products by [Coilcraft](#) manufacturer:

Other Similar products are found below :

[CR32NP-100KC](#) [70F224AI](#) [MHQ1005P10NJ](#) [MHQ1005P1N0S](#) [MHQ1005P2N4S](#) [MHQ1005P3N6S](#) [MHQ1005P5N1S](#) [MHQ1005P8N2J](#)
[PE-53601NL](#) [PE-53602NL](#) [PG0936.113NLT](#) [9220-20](#) [9310-16](#) [PM06-2N7](#) [PM06-39NJ](#) [A01TK](#) [1206CS-471XJ](#) [HC2-R47-R](#) [HC8-1R2-R](#)
[HCF1305-3R3-R](#) [1206CS-151XG](#) [RCH664NP-4R7M](#) [RCP1317NP-391L](#) [DH2280-4R7M](#) [DS1608C-106](#) [B10TJ](#) [B82498B3101J000](#) [ELJ-](#)
[RE27NJF2](#) [1812CS-153XJ](#) [1812CS-183XJ](#) [1812CS-223XJ](#) [1812LS-104XJ](#) [1812LS-105XJ](#) [1812LS-124XJ](#) [1812LS-154XJ](#) [1812LS-223XJ](#)
[1812LS-224XJ](#) [1812LS-563XJ](#) [1812LS-683XJ](#) [1812LS-824XJ](#) [NIN-FB101JTR110F](#) [NIN-FB471JTR62F](#) [NIN-FC1R5JTR220F](#) [NIN-](#)
[HCR15JTRF](#) [NIN-HCR33JTRF](#) [NIN-HDR22JTRF](#) [NIN-HDR82JTRF](#) [NIN-HK2N7STRF](#) [NIN-PA150KTR370F](#) [NIN-PB100KTR550F](#)