

Power Filter Inductor

For Zetex ZXCD1210
Analog Input Class D Modulator

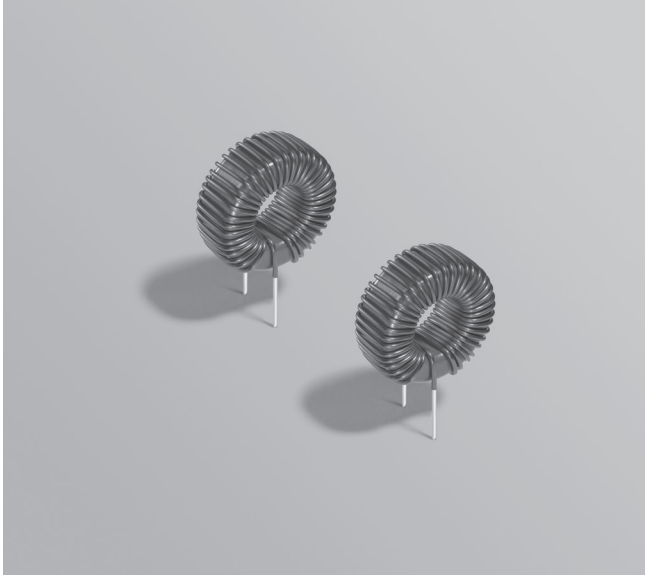

This toroidal choke was developed for Zetex Semiconductors ZXCD1210 High performance analog input Class D modulator. This application provides up to 500 Wrms into 4 Ohms. The ED0006-AL is the low pass filter for the high frequency switching PWM signal, enabling recovery of the lower frequency audio signal.

Request free evaluation samples by contacting Coilcraft or visiting www.coilcraft.com.

Part number	Inductance $\pm 20\%$ ¹ (μH)	DCR max ² (mOhms)	SRF min (MHz)	Isat ³ (A)	Irms (A) ⁴	
					20°C rise	40°C rise
ED0006-AL	20	42	13	36.0	5.1	7.2

- Inductance measured at 100 kHz, 100 mVrms, 0 Adc using an Agilent/HP 4132 impedance analyzer or equivalent.
- DCR measured on a Valhalla 4105 ATC digital ohmmeter or equivalent.
- DC current at which the inductance drops 10% (typ) from its value without current.
- Current that causes the specified temperature rise from 25°C ambient.
- Ambient temperature range:** -40°C to +125°C with Irms current
+125°C to +165°C with derated current
- Storage temperature range:** Component: -40°C to +165°C
Packaging: -40°C to +80°C.
- Electrical specifications at 25°C.

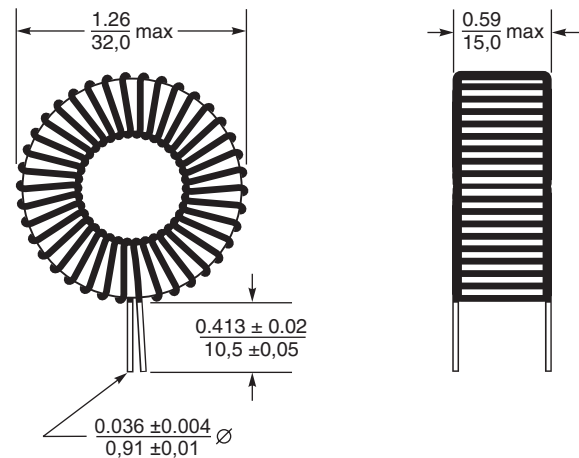

Weight: 30.8 g
Terminations: Tin-silver-copper over copper
Packaging: 25 per tray



Power Filter Inductor – ED0006-AL

L vs Current L vs Frequency

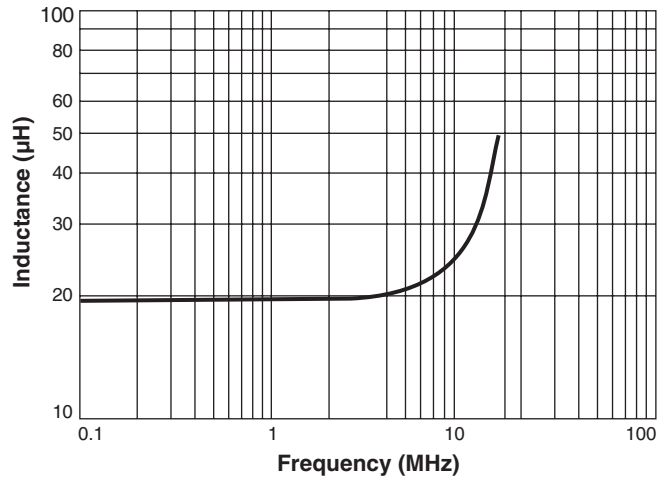
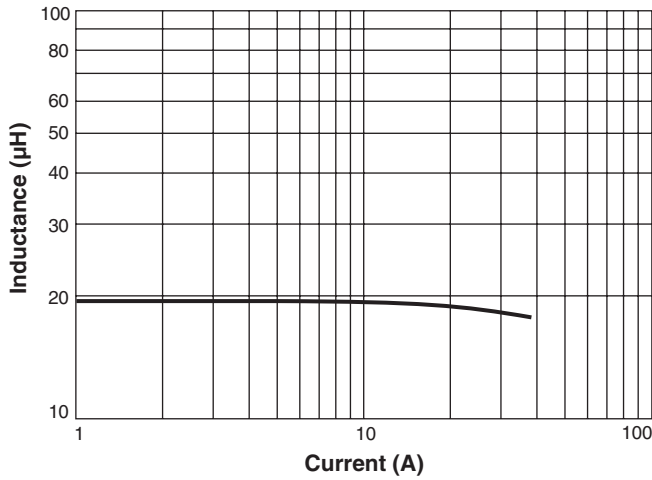

Temperature Rise vs Current ESR vs Frequency

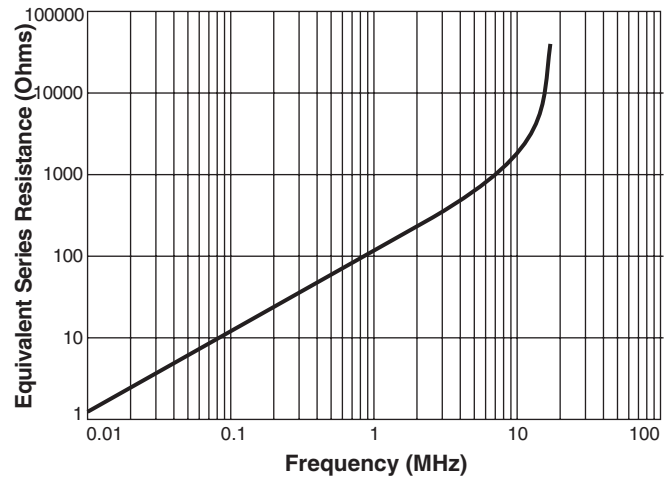
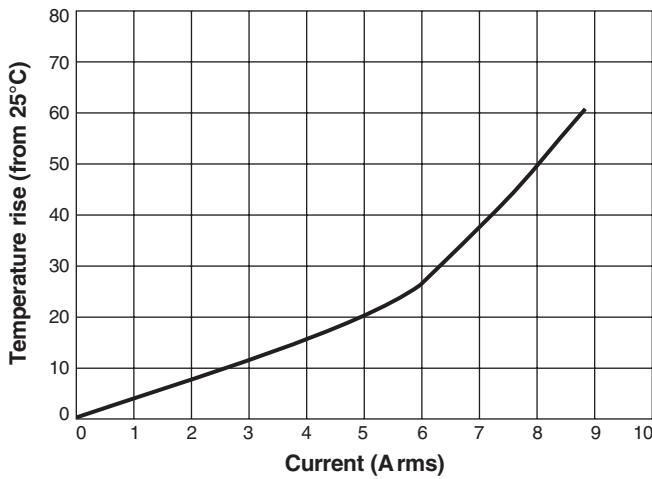

Irms Derating

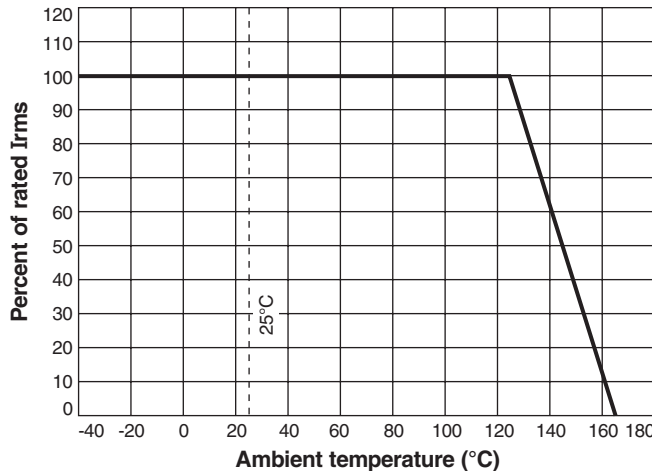

US +1-847-639-6400 sales@coilcraft.com
UK +44-1236-730595 sales@coilcraft-europe.com
Taiwan +886-2-2264 3646 sales@coilcraft.com.tw
China +86-21-6218 8074 sales@coilcraft.com.cn
Singapore + 65-6484 8412 sales@coilcraft.com.sg

Document 565-2 Revised 02/21/19
 © Coilcraft Inc. 2019
 This product may not be used in medical or high risk applications without prior Coilcraft approval. Specification subject to change without notice. Please check web site for latest information.

X-ON Electronics

Largest Supplier of Electrical and Electronic Components

Click to view similar products for [Fixed Inductors](#) category:

Click to view products by [Coilcraft](#) manufacturer:

Other Similar products are found below :

[CR43NP-680KC](#) [CR54NP-820KC](#) [CR54NP-8R5MC](#) [CTX32CT-100](#) [70F224AI](#) [MGDQ4-00004-P](#) [MHL1ECTTP18NJ](#) [MHL1JCTTD12NJ](#)
[PE-51506NL](#) [PE-53601NL](#) [PE-53602NL](#) [PE-53630NL](#) [PE-53824SNLT](#) [PE-92100NL](#) [PG0434.801NLT](#) [PG0936.113NLT](#) [9310-16](#) [PM06-2N7](#) [PM06-39NJ](#) [A01TK](#) [1206CS-471XJ](#) [HC2-2R2TR](#) [HC2LP-R47-R](#) [HC3-2R2-R](#) [1206CS-151XG](#) [RCH664NP-140L](#) [RCH664NP-4R7M](#)
[RCH8011NP-221L](#) [RCP1317NP-332L](#) [RCP1317NP-391L](#) [RCR1010NP-470M](#) [RCR110DNP-331L](#) [DH2280-4R7M](#) [DS1608C-106](#) [ASPI-4020HI-R10M-T](#) [B10TJ](#) [B82477P4333M](#) [B82498B3101J000](#) [B82498B3680J000](#) [ELJ-RE27NJF2](#) [1812CS-153XJ](#) [1812CS-183XJ](#) [1812CS-223XJ](#) [1812LS-104XJ](#) [1812LS-105XJ](#) [1812LS-124XJ](#) [1812LS-154XJ](#) [1812LS-223XJ](#) [1812LS-224XJ](#) [1812LS-563XJ](#)