

Shielded Coupled Inductors MSD7342

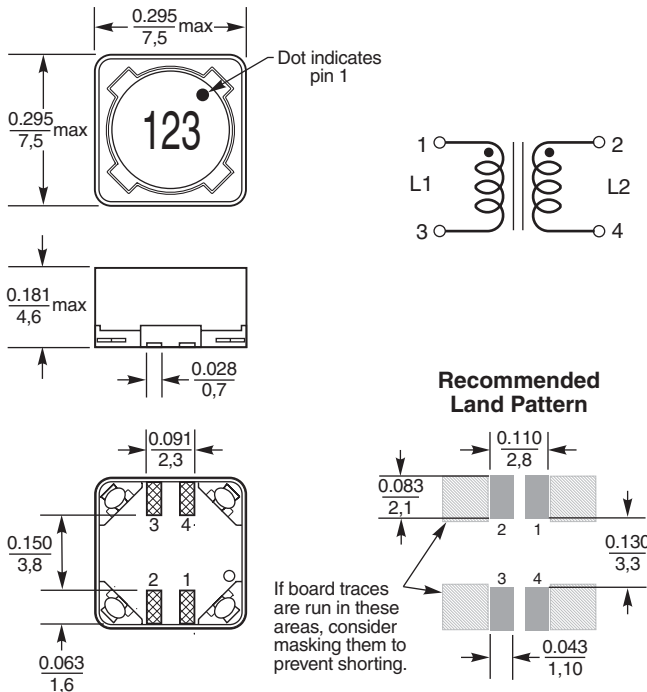

Dimensions are in $\frac{\text{inches}}{\text{mm}}$

- Tight coupling ($k \geq 0.97$) and 200V isolation make the MSD7342 series of coupled inductors ideal for use in a variety of circuits including flyback, multi-output buck and SEPIC.
- They provide high inductance, high efficiency and excellent current handling in a rugged, low cost part.
- Can also be used as two single inductors connected in series or parallel, as a common mode choke or as a 1 : 1 transformer.

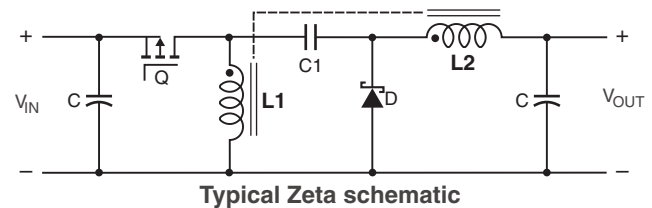
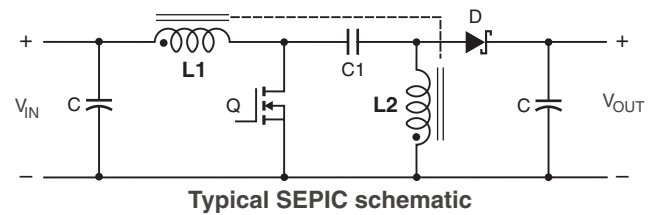
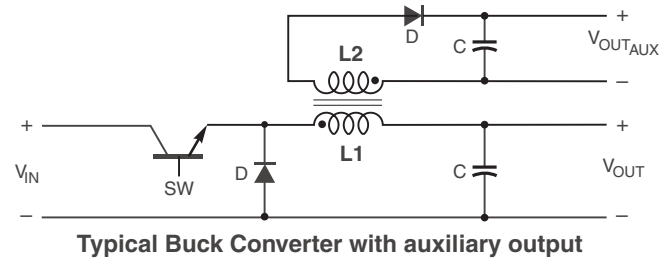
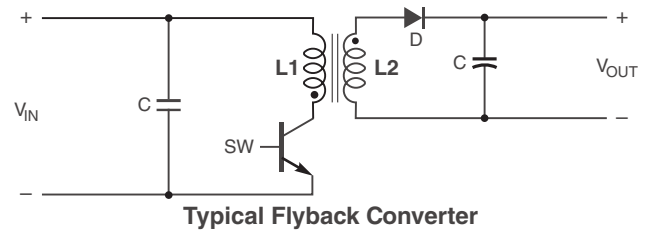

US +1-847-639-6400 sales@coilcraft.com
UK +44-1236-730595 sales@coilcraft-europe.com
Taiwan +886-2-2264 3646 sales@coilcraft.com.tw
China +86-21-6218 8074 sales@coilcraft.com.cn
Singapore + 65-6484 8412 sales@coilcraft.com.sg

Document 621-1 Revised 11/09/15
 © Coilcraft Inc. 2017
 This product may not be used in medical or high risk applications without prior Coilcraft approval. Specification subject to change without notice. Please check web site for latest information.



Shielded Coupled Inductors – MSD7342 Series

Part number ¹	Inductance ² ±20% (µH)	DCR max ³ (Ohms)	SRF typ ⁴ (MHz)	Coupling coefficient typ	Leakage L typ ⁵ (µH)	Isat (A) ⁶			Irms (A)	
						10% drop	20% drop	30% drop	both windings ⁷	one winding ⁸
MSD7342-252ML_	2.5	0.033	55	0.97	0.14	6.0	6.2	6.3	2.17	3.06
MSD7342-332ML_	3.3	0.037	43	0.99	0.09	5.2	5.3	5.4	2.05	2.89
MSD7342-472ML_	4.7	0.051	35	0.99	0.11	4.1	4.3	4.6	1.74	2.46
MSD7342-562ML_	5.6	0.063	32	0.99	0.09	3.9	4.1	4.2	1.57	2.22
MSD7342-682ML_	6.8	0.070	30	0.99	0.14	3.7	3.8	3.9	1.49	2.10
MSD7342-822ML_	8.2	0.075	27	0.98	0.25	3.3	3.4	3.5	1.44	2.03
MSD7342-103ML_	10	0.100	22	0.98	0.30	2.8	2.9	3.0	1.24	1.76
MSD7342-123ML_	12	0.120	20	0.98	0.36	2.5	2.6	2.7	1.14	1.61
MSD7342-153ML_	15	0.130	18	0.98	0.49	2.2	2.3	2.4	1.09	1.54
MSD7342-183ML_	18	0.170	15	>0.99	0.16	2.0	2.2	2.3	0.95	1.35
MSD7342-223ML_	22	0.220	13.5	>0.99	0.20	1.9	2.0	2.1	0.84	1.19
MSD7342-273ML_	27	0.250	12.0	>0.99	0.20	1.7	1.8	1.9	0.79	1.11
MSD7342-333ML_	33	0.270	11.0	>0.99	0.15	1.5	1.6	1.7	0.76	1.07
MSD7342-393ML_	39	0.380	10.0	0.99	0.70	1.3	1.4	1.5	0.64	0.90
MSD7342-473ML_	47	0.420	9.5	>0.99	0.30	1.2	1.3	1.4	0.61	0.86
MSD7342-563ML_	56	0.460	8.7	>0.99	0.51	1.1	1.2	1.3	0.58	0.82
MSD7342-683ML_	68	0.600	7.3	>0.99	0.51	1.0	1.1	1.2	0.51	0.72
MSD7342-823ML_	82	0.680	6.2	0.99	1.17	0.90	1.00	1.1	0.48	0.67
MSD7342-104ML_	100	0.770	5.5	>0.99	0.96	0.80	0.92	0.98	0.45	0.63
MSD7342-124ML_	120	1.03	4.5	>0.99	0.61	0.70	0.80	0.90	0.39	0.55
MSD7342-154ML_	150	1.35	4.0	>0.99	0.54	0.65	0.76	0.80	0.34	0.48
MSD7342-184ML_	180	1.52	3.8	>0.99	0.75	0.62	0.66	0.73	0.32	0.45
MSD7342-224ML_	220	1.72	3.5	>0.99	1.43	0.59	0.62	0.66	0.30	0.42
MSD7342-274ML_	270	2.41	3.3	>0.99	1.56	0.55	0.57	0.60	0.25	0.36
MSD7342-334ML_	330	2.70	3.0	>0.99	1.65	0.49	0.52	0.54	0.24	0.34
MSD7342-394ML_	390	3.05	2.8	0.99	4.73	0.45	0.47	0.50	0.23	0.32
MSD7342-474ML_	470	4.00	2.6	0.99	5.50	0.41	0.43	0.46	0.20	0.28
MSD7342-564ML_	560	4.43	2.5	>0.99	4.85	0.38	0.40	0.42	0.19	0.26
MSD7342-684ML_	680	5.00	2.3	0.99	7.59	0.36	0.37	0.38	0.18	0.25
MSD7342-824ML_	820	6.80	2.2	>0.99	8.01	0.30	0.32	0.35	0.15	0.21
MSD7342-105ML_	1000	7.80	2.0	>0.99	8.69	0.27	0.29	0.31	0.14	0.20

1. When ordering, please specify **termination** and **packaging** codes:

MSD7342-105MLC

Termination: L = RoHS compliant matte tin over nickel over phos bronze. Special order: **T** = RoHS tin-silver-copper (95.5/4/0.5) or **S** = non-RoHS tin-lead (63/37).

Packaging: C = 7" machine-ready reel. EIA-481 embossed plastic tape (250 parts per full reel).

B = Less than full reel. In tape, but not machine ready. To have a leader and trailer added (\$25 charge), use code letter C instead.

D = 13" machine-ready reel. EIA-481 embossed plastic tape. Factory order only, not stocked (1000 parts per full reel).

- Inductance shown for each winding, measured at 100 kHz, 0.1 Vrms, 0 Adc on an Agilent/HP 4284A LCR meter or equivalent. When leads are connected in parallel, inductance is the same value. When leads are connected in series, inductance is four times the value.
- DCR is for each winding. When leads are connected in parallel, DCR is half the value. When leads are connected in series, DCR is twice the value.
- SRF measured using an Agilent/HP 4191A or equivalent. When leads are connected in parallel, SRF is the same value.

5. Leakage inductance is for L1 and is measured with L2 shorted.

6. DC current, at which the inductance drops the specified amount from its value without current. It is the sum of the current flowing in both windings.

7. Equal current when applied to each winding simultaneously that causes a 40°C temperature rise from 25°C ambient. This information is for reference only and does not represent absolute maximum ratings. To predict temperature rise [go to online calculator](#).

8. Maximum current when applied to one winding that causes a 40°C temperature rise from 25°C ambient. This information is for reference only and does not represent absolute maximum ratings. To predict temperature rise [go to online calculator](#).

9. Electrical specifications at 25°C.

Refer to Doc 639 "Selecting Coupled Inductors for SEPIC Applications." Refer to Doc 362 "Soldering Surface Mount Components" before soldering.

Coupled Inductor Core and Winding Loss Calculator

This web-based utility allows you to enter frequency, peak-to-peak (ripple) current, and Irms current to predict temperature rise and overall losses, including core loss. [Go to online calculator](#)



www.coilcraft.com

US +1-847-639-6400 sales@coilcraft.com
UK +44-1236-730595 sales@coilcraft-europe.com
Taiwan +886-2-2264 3646 sales@coilcraft.com.tw
China +86-21-6218 8074 sales@coilcraft.com.cn
Singapore +65-6484 8412 sales@coilcraft.com.sg

Document 621-2 Revised 11/09/15

© Coilcraft Inc. 2017

This product may not be used in medical or high risk applications without prior Coilcraft approval. Specification subject to change without notice. Please check web site for latest information.



Shielded Coupled Inductors – MSD7342 Series

Typical L vs Current

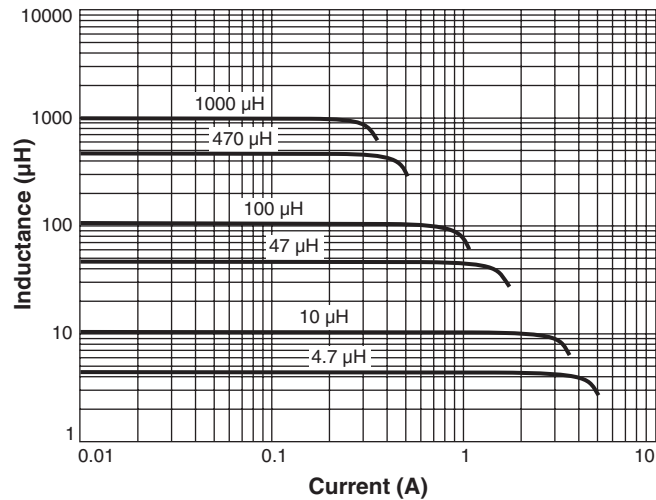

Typical L vs Frequency

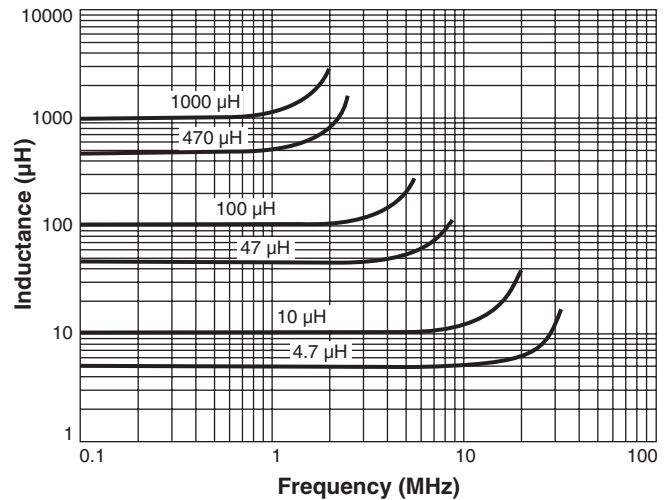

Core material Ferrite

Core and winding loss [Go to online calculator](#)

Terminations RoHS compliant matte tin over nickel over phosphor bronze. Other terminations available at additional cost.

Weight 0.76 – 0.87g

Ambient temperature –40°C to +85°C with (40°C rise) Irms current.

Maximum part temperature +125°C (ambient + temp rise).

Storage temperature Component: –40°C to +125°C.

Tape and reel packaging: –40°C to +80°C

Winding to winding isolation 200 Vrms, one minute

Resistance to soldering heat Max three 40 second reflows at +260°C, parts cooled to room temperature between cycles

Moisture Sensitivity Level (MSL) 1 (unlimited floor life at <30°C / 85% relative humidity)

Failures in Time (FIT) / Mean Time Between Failures (MTBF)

38 per billion hours / 26,315,789 hours, calculated per Telcordia SR-332

Packaging 250/7" reel; 1000/13" reel Plastic tape: 16 mm wide, 0.4 mm thick, 12 mm pocket spacing, 4.9 mm pocket depth

PCB washing Tested to MIL-STD-202 Method 215 plus an additional aqueous wash. See [Doc787_PCB_Washing.pdf](#).



www.coilcraft.com

US +1-847-639-6400 sales@coilcraft.com

UK +44-1236-730595 sales@coilcraft-europe.com

Taiwan +886-2-2264 3646 sales@coilcraft.com.tw

China +86-21-6218 8074 sales@coilcraft.com.cn

Singapore + 65-6484 8412 sales@coilcraft.com.sg

Document 621-3 Revised 11/09/15

© Coilcraft Inc. 2017

This product may not be used in medical or high risk applications without prior Coilcraft approval. Specification subject to change without notice. Please check web site for latest information.

X-ON Electronics

Largest Supplier of Electrical and Electronic Components

Click to view similar products for [Coupled Inductors](#) category:

Click to view products by [Coilcraft](#) manufacturer:

Other Similar products are found below :

[NPIS48LS1R0YTRF](#) [NPIS21LS2R2MTRF](#) [NIN-HCR27JTRF](#) [744874470](#) [CPL-4-50TR-R](#) [CTX20-1A-R](#) [CL1208-2-100TR-R](#) [SDQ25-470-R](#)
[LPD5030-153MRC](#) [LPD5030-105MRC](#) [MSD1260-154KLD](#) [MSD1260-224KLD](#) [MSD1260-474KLD](#) [MSD1260-472MLD](#) [MSD1260-103MLD](#) [MSD1260-153MLD](#) [MSD1278-154KLD](#) [MSD1583-103MED](#) [MSD1583-223MED](#) [MSD1583-683MED](#) [MSD7342-224MLC](#)
[MSD7342-824MLC](#) [PFD3215-103MEC](#) [LPD3015-332MRC](#) [LPD3015-223MRC](#) [LPD3015-104MRC](#) [LPD4012-223MRC](#) [LPD4012-331NRC](#)
[LPD5010-822MRC](#) [LPD6235-155MRC](#) [MSD1514-224KED](#) [MSD1514-472MED](#) [MSD1260-473MLD](#) [MSD1260-683MLD](#) [B82477D4223M](#)
[CTX8-1-R](#) [CTX16-17769-R](#) [HM78D-1210680MLFTR](#) [CTX150-4A-R](#) [CL-12-24](#) [47330C](#) [47220C](#) [7023](#) [PM3602-25-RC](#) [PM3602-100-RC](#)
[PM3602-5-RC](#) [PM3602-200-RC](#) [PM3602-20-RC](#) [PM3602-250-RC](#) [PM3602-50-RC](#)