

Miniature SMT Transformers

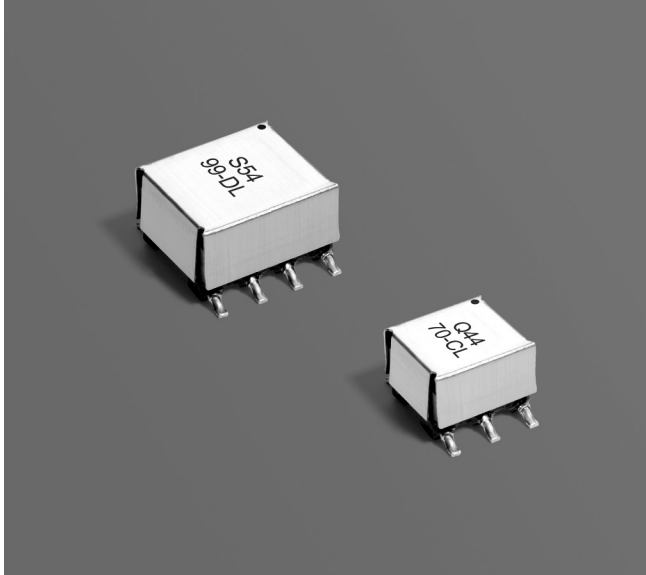

These miniature transformers were developed for use with Maxim RS-232/RS-485 interface ICs, and are suitable for gate drive and other power applications. They were designed to work with the MAX250, MAX251, MAX253 and MAX845 for providing power to the isolated side of the interface, and are also specified by Linear Technology, Sipex and others for use with their chipsets.

They feature 1500 Vrms isolation between windings in a miniature surface mount package. Each transformer has a stainless steel cover that provides an excellent surface for automated placement.

In addition to the standard parts shown, Coilcraft can produce custom transformers with voltage, inductance and DCR values to meet your specific requirements. For more information, contact Coilcraft.

Part number ¹	Pri / sec voltage	Inductance min (µH)	Volt-time product ² typ (Vµsec)	DCR max (Ohms)		Isolation pri-sec (Vrms)	Pri/sec capacitance typ (pF) ³	Pri:sec Turns ratio ⁴	Power ⁵ (W)	Size
				pri	sec					
Q4470-CL	5 V to 5 V	400 (1-3)	32 (1-3)	0.950 (1-3)	1.25 (6-4)	1500 (1-4)	0.87	1 CT: 1.3 CT	0.25	C
S5394-CL	5 V to 10 V	400 (1-3)	32 (1-3)	0.950 (1-3)	0.950 (6-4)	1500 (1-4)	0.92	1 CT: 1	0.25	C
U6982-CL	3.3 V to 5 V	59 (1-3)	22 (1-3)	0.700 (1-3)	1.800 (6-4)	1500 (1-4)	0.93	1 CT: 2.1 CT	0.75	C
T6437-DL	5 V to 5V	1000 (1-4)	134 (1-4)	1.010 (1-2, 3-4)	1.955 (8-5)	1500 (1,3-8)	1.88	1 CT: 1	1.5	D
S5499-DL	5 V to 24 V	160 (1-4)	48 (1-4)	0.540 (1-2, 3-4)	4.28 (8-7, 6-5)	1500 (1,3-8,6)	1.59	1 CT: 5 CT	1.0	D
T6650-DL	5 V to 24 V	176 (2-3)	48 (2-3)	1.015 (2-3)	8.250 (7-6)	1500 (2-7)	1.25	1:5	1.0	D

1. When ordering, please specify **packaging** code:

Q4470-CLD

Packaging: D = 13" machine-ready reel. EIA-481 embossed plastic tape (Size C: 1000 per full reel; Size D: 500 per full reel).

B = Less than full reel. In tape, but not machine ready. To have a leader and trailer added (\$25 charge), use code letter D instead.

- Volt-time product is based on core area, number of primary turns and 4800 Gauss flux density.
 - Capacitance measured from full primary to full secondary at 200 kHz.
 - CT indicates center tap.
 - Calculated output power based on 150 kHz operating frequency. Power varies depending on application.
 - Ambient temperature range: -40°C to +85°C
 - Storage temperature range: Component: -40°C to +85°C
Tape and reel packaging: -40°C to +80°C
 - Resistance to soldering heat: Three reflows at >217°C for 90 seconds (+260°C ±5°C for 20 – 40 seconds), allowing parts to cool to room temperature between.
 - Electrical specifications at 25°C.
- Refer to Doc 362 "Soldering Surface Mount Components" before soldering.

	Chipset						
	Linear LT1952	Linear LTC3900	Maxim 250/251	Maxim 253/845	Maxim 3535E	Sipex SP3222	Sipex SP3232
Q4470-CL	✓	✓		✓	✓		
S5394-CL				✓			
U6982-CL				✓	✓	✓	✓
T6437-DL			✓				
S5499-DL				✓			
T6650-DL				✓			

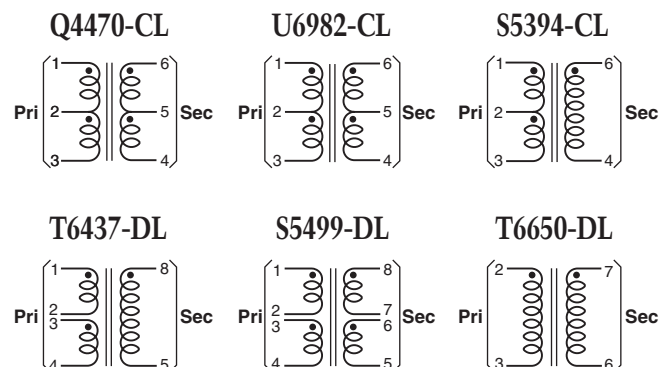



Miniature SMT Transformers

C Size

Q4470-CL, S5394-CL, U6982-CL

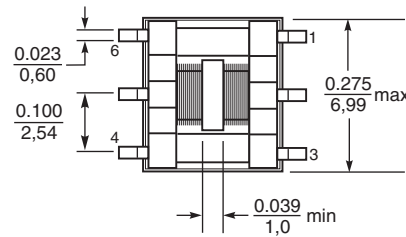
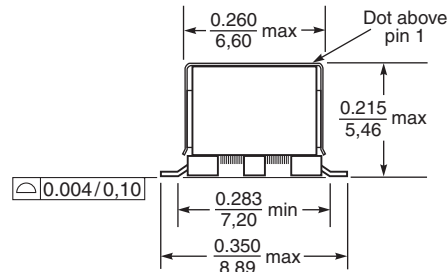
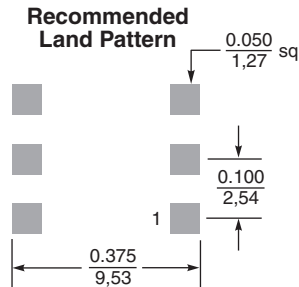

Bottom View

Weight 510 – 550 mg

Terminations Tin-silver over tin over nickel over phos bronze

Packaging 1000 per 13" reel Plastic tape: 16 mm wide, 0.34 mm thick, 12 mm pocket spacing, 5.33 mm pocket depth

D Size

S5499-DL, T6437-DL, T6650-DL

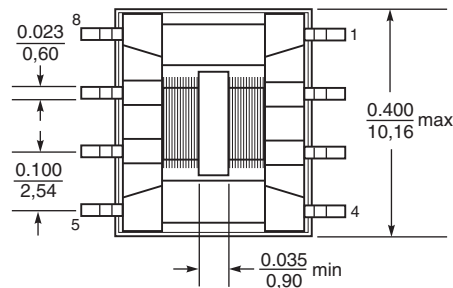
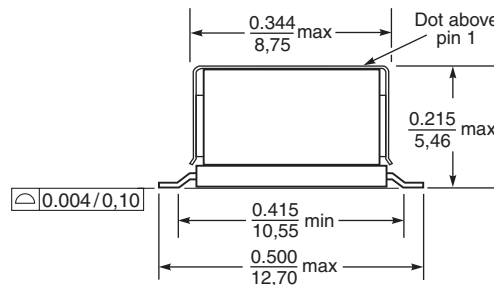
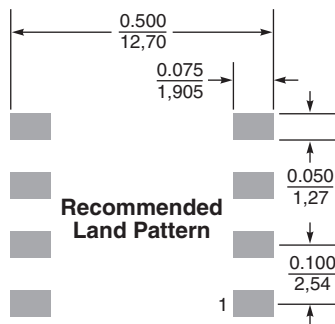

Bottom View

Weight 0.98 – 1.1 g

Terminations Tin-silver over tin over nickel over phos bronze

Tape and reel 500 per 13" reel Plastic tape: 24 mm wide, 0.36 mm thick, 16 mm pocket spacing, 6.13 mm pocket depth



www.coilcraft.com

US +1-847-639-6400 sales@coilcraft.com
UK +44-1236-730595 sales@coilcraft-europe.com
Taiwan +886-2-2264 3646 sales@coilcraft.com.tw
China +86-21-6218 8074 sales@coilcraft.com.cn
Singapore +65-6484 8412 sales@coilcraft.com.sg

Document 606-2 Revised 05/06/09

© Coilcraft Inc. 2013

This product may not be used in medical or high risk applications without prior Coilcraft approval. Specification subject to change without notice. Please check web site for latest information.

X-ON Electronics

Largest Supplier of Electrical and Electronic Components

Click to view similar products for [Pulse Transformers](#) category:

Click to view products by [Coilcraft](#) manufacturer:

Other Similar products are found below :

[E4001NLT](#) [1879401-1](#) [IF-18-0269-N](#) [T1042NLT](#) [T1049NL](#) [PE-68023NL](#) [PH0905NL](#) [PT4163S](#) [PT5010](#) [PA0173NLT](#) [CTX02-14608](#) [PE-65457NLT](#) [T60403-D4721-X088](#) [H1183NLT](#) [CTX33-18971-R](#) [HM2108NLT](#) [HM0068ANLT](#) [PG1427.001NLT](#) [750031353](#) [PH9400.566NLT](#) [PH9400.655ANLT](#) [PH9400.655NLT](#) [PH9385.013NLT](#) [B78307X0001](#) [B78307A2276A003](#) [HX6096FNL](#) [HX6106NLT](#) [P0926NL](#) [HX6096NL](#) [PA3493NLT](#) [P0585ANL](#) [HU4102NL](#) [PH9385.012NLT](#) [PH9400.111NLT](#) [PH9400.211NLT](#) [PH9400.233ANLT](#) [SMQC1553-6](#) [78615/9JC-R](#) [SMQ1553-45](#) [Q1553-45](#) [Q1553-22](#) [Q1553-21](#) [PH9400.211ANLT](#) [TGM-050P3RL](#) [TGMS-1464V6LF](#) [TGRAD-560V8LF](#) [TGMR-360V6LF](#) [P0544](#) [PA0264NLT](#) [T60403-D4215-X014](#)