

2N7002KDW-HF

**N-Channel
RoHS Device
Halogen Free**

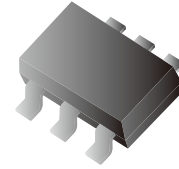

Features

- High density cell design for low $R_{DS(ON)}$.
- Voltage controlled small signal switch.
- High saturation current capability.
- ESD protected.

Mechanical data

- Case: SOT-363, molded plastic.
- Epoxy: UL 94V-0 flammability rating.

Circuit Diagram

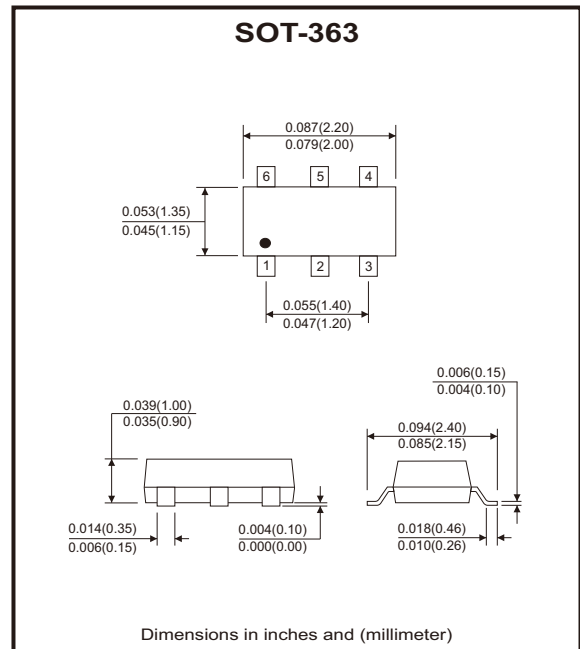
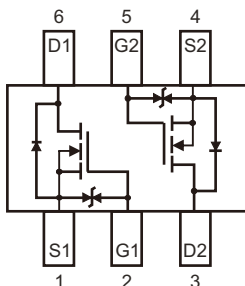

Maximum Ratings (at $T_A=25^{\circ}C$ unless otherwise noted)

Parameter	Symbol	Value	Unit
Drain-Source voltage	V_{DS}	60	V
Gate-Source voltage	V_{GS}	± 20	V
Drain current	I_D	340	mA
Total power dissipation	P_D	150	mW
Thermal resistance from junction to ambient	$R_{\theta JA}$	820	$^{\circ}C/W$
Junction temperature	T_J	150	$^{\circ}C$
Storage temperature range	T_{STG}	-55 to +150	$^{\circ}C$

Electrical Characteristics (at T_A=25°C unless otherwise noted)

Parameter	Conditions	Symbol	Min	Typ	Max	Unit
Static Characteristics						
Drain-Source breakdown voltage	V _{GS} = 0V, I _D = 250μA	V _{(BR)DSS}	60			V
Gate-Threshold voltage (Note 1)	V _{DS} = V _{GS} , I _D = 1mA	V _{GS(th)}	1		2.5	V
Gate-body leakage	V _{DS} = 0V, V _{GS} = ±20V	I _{GSS}			±10	μA
Zero gate voltage drain current	V _{DS} = 48V, V _{GS} = 0V	I _{DSS}			1	μA
Drain-Source on-resistance (Note 1)	V _{GS} = 4.5V, I _D = 200mA	R _{DS(ON)}			5.3	Ω
	V _{GS} = 10V, I _D = 500mA				5	
Diode forward voltage (Note 1)	V _{GS} = 0V, I _S = 300mA	V _{SD}			1.5	V
Recovered charge	V _{GS} = 0V, I _S = 300mA, V _R = 25V dI _S /dt = -100A/μs	Q _r		30		nC
Dynamic Characteristics						
Input capacitance	V _{DS} = 10V, V _{GS} = 0V, f = 1MHz	C _{iss}			40	pF
Output capacitance		C _{oss}			30	pF
Reverse transfer capacitance		C _{rss}			10	pF
Switching Characteristics						
Turn-on delay time	V _{DD} = 50V, V _{GS} = 10V, R _L = 250Ω	t _{d(on)}			10	ns
Turn-off delay time	R _{GS} = 50Ω, R _{GEN} = 50Ω	t _{d(off)}			15	ns
Reverse recovery time	V _{GS} = 0V, I _S = 300mA, V _R = 25V dI _S /dt = -100A/μs	t _{rr}		30		ns
Gate-Source Zener Diode						
Gate-Source breakdown voltage	I _{GS} = ±1mA (open drain)	BV _{GSO}	±21.5		±30	V

Notes: 1. Pulse test: Pulse width ≤ 300μs, duty cycle ≤ 2%.

Rating and Characteristic Curves (2N7002KDW-HF)

Fig.1 - Output Characteristics

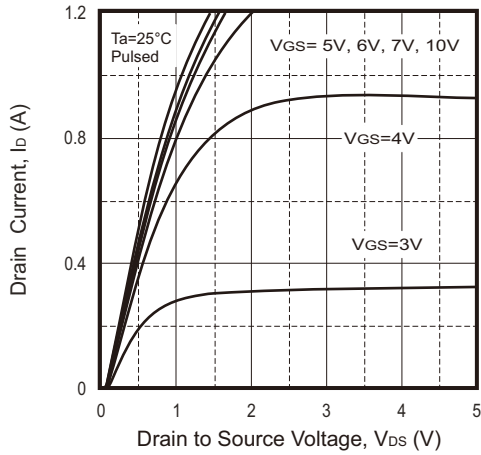

Fig.2 - Transfer Characteristics

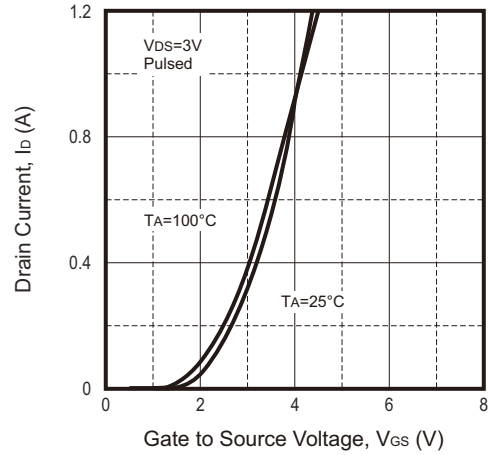

Fig.3 - $R_{DS(ON)} - I_D$

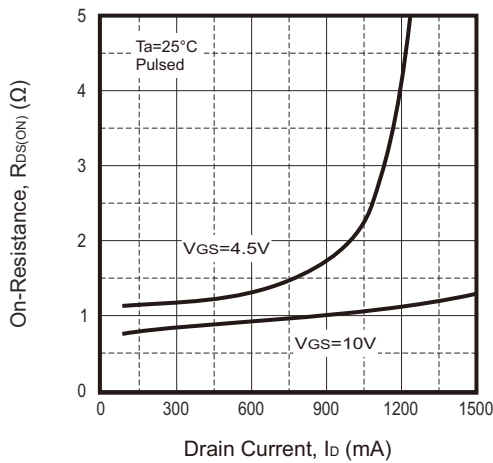

Fig.4 - $R_{DS(ON)} - V_{GS}$

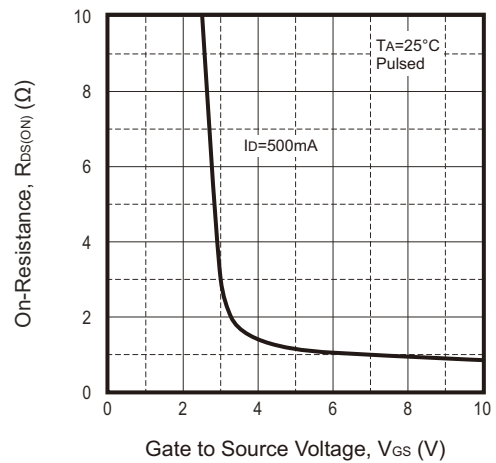

Fig.5 - $I_S - V_{SD}$

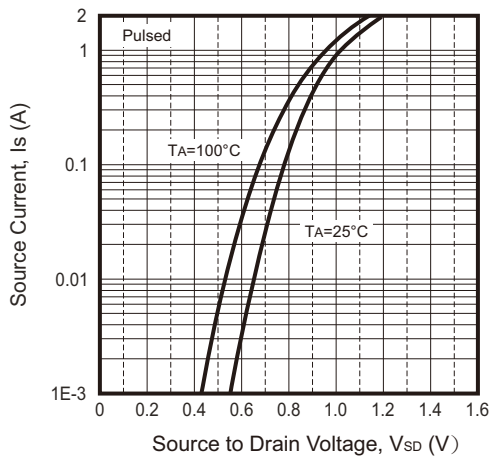
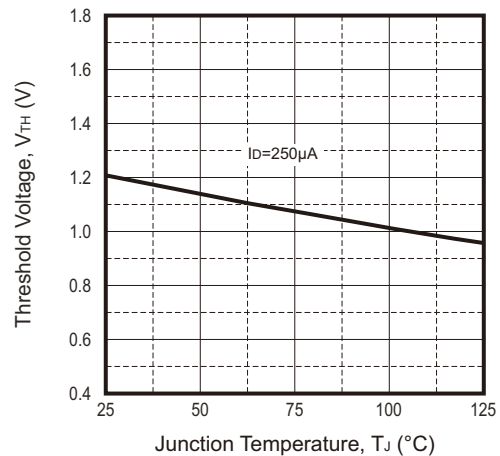
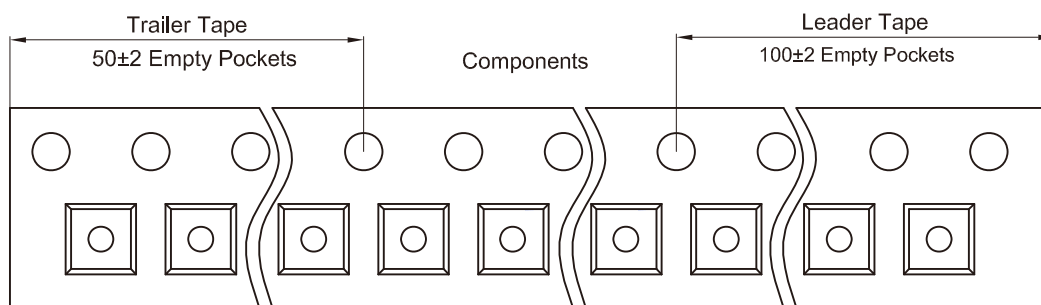
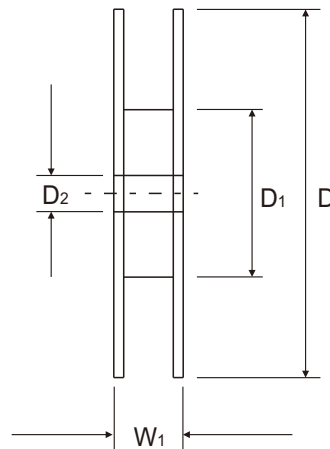
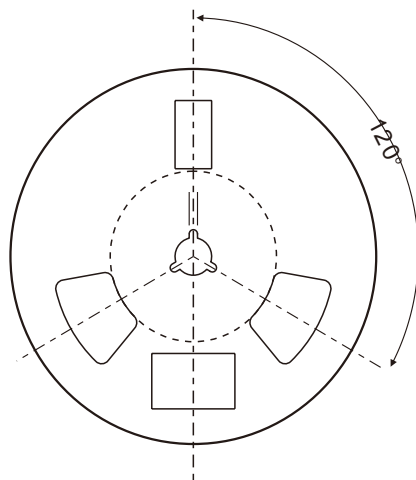
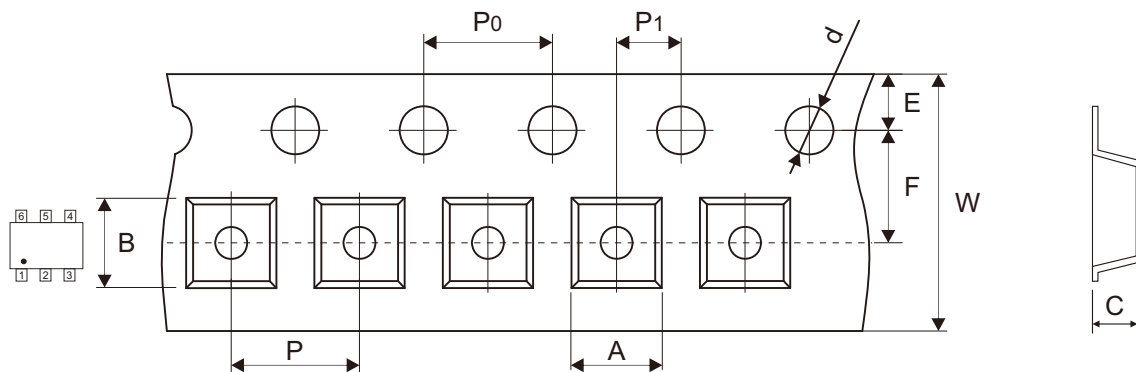

Fig.6 - Threshold Voltage



Company reserves the right to improve product design, functions and reliability without notice.

Reel Taping Specification



SOT-363	SYMBOL	A	B	C	d	D	D1	D2
	(mm)	2.40 ± 0.10	2.55 ± 0.10	1.20 ± 0.10	1.50 ± 0.10	178.00 ± 1.00	54.40 ± 0.50	13.00 ± 0.20
	(inch)	0.094 ± 0.004	0.100 ± 0.004	0.047 ± 0.004	0.059 ± 0.004	7.008 ± 0.039	2.142 ± 0.020	0.512 ± 0.008

SOT-363	SYMBOL	E	F	P	P0	P1	W	W1
	(mm)	1.75 ± 0.10	3.50 ± 0.05	4.00 ± 0.10	4.00 ± 0.10	2.00 ± 0.05	8.00 + 0.30 - 0.10	13.10 ± 1.30
	(inch)	0.069 ± 0.004	0.138 ± 0.002	0.157 ± 0.004	0.157 ± 0.004	0.079 ± 0.002	0.315 + 0.012 - 0.004	0.516 ± 0.051

Company reserves the right to improve product design, functions and reliability without notice.

REV:A

Marking Code

Part Number	Marking Code
2N7002KDW-HF	72K

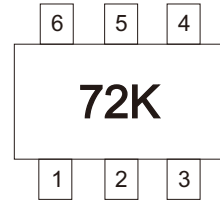

Suggested PAD Layout

SIZE	SOT-363	
	(mm)	(inch)
A	0.40	0.016
B	0.816	0.032
C	0.65	0.026
D	1.94	0.076

Note: 1. The pad layout is for reference purposes only.

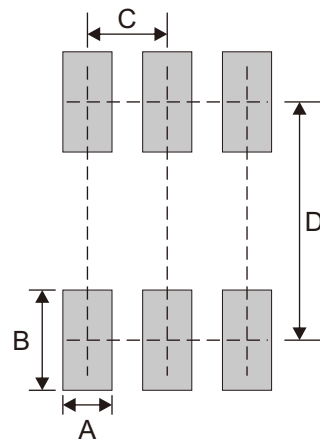

Standard Packaging

Case Type	REEL PACK	
	REEL (pcs)	Reel Size (inch)
SOT-363	3,000	7

X-ON Electronics

Largest Supplier of Electrical and Electronic Components

Click to view similar products for [MOSFET](#) category:

Click to view products by [Comchip](#) manufacturer:

Other Similar products are found below :

[614233C](#) [648584F](#) [IRFD120](#) [JANTX2N5237](#) [2N7000](#) [FCA20N60_F109](#) [FDZ595PZ](#) [2SK2545\(Q,T\)](#) [405094E](#) [423220D](#)
[TPCC8103,L1Q\(CM](#) [MIC4420CM-TR](#) [VN1206L](#) [614234A](#) [715780A](#) [NTNS3166NZT5G](#) [SSM6J414TU,LF\(T](#) [751625C](#)
[IPS70R2K0CEAKMA1](#) [BUK954R8-60E](#) [DMN3404LQ-7](#) [NTE6400](#) [SQJ402EP-T1-GE3](#) [2SK2614\(TE16L1,Q\)](#) [2N7002KW-FAI](#)
[DMN1017UCP3-7](#) [EFC2J004NUZTDG](#) [ECH8691-TL-W](#) [FCAB21350L1](#) [P85W28HP2F-7071](#) [DMN1053UCP4-7](#) [NTE221](#) [NTE2384](#)
[NTE2903](#) [NTE2941](#) [NTE2945](#) [NTE2946](#) [NTE2960](#) [NTE2967](#) [NTE2969](#) [NTE2976](#) [NTE455](#) [NTE6400A](#) [NTE2910](#) [NTE2916](#) [NTE2956](#)
[NTE2911](#) [US6M2GTR](#) [TK10A80W,S4X\(S](#) [SSM6P69NU,LF](#)