

ACDBT-54-HF Series

Reverse Voltage: 30 Volts

Forward Current: 200 mA

RoHS Device

Halogen free

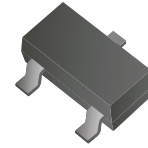

Features

- Fast switching.
- Low turn-on voltage.
- PN junction guard ring for transient and ESD protection.
- Comply with AEC-Q101.

Mechanical data

- Case: SOT-23, molded plastic.
- Terminals: Solderable per MIL-STD-750, method 2026.
- Weight: 0.0078 grams(approx.).

Circuit diagram

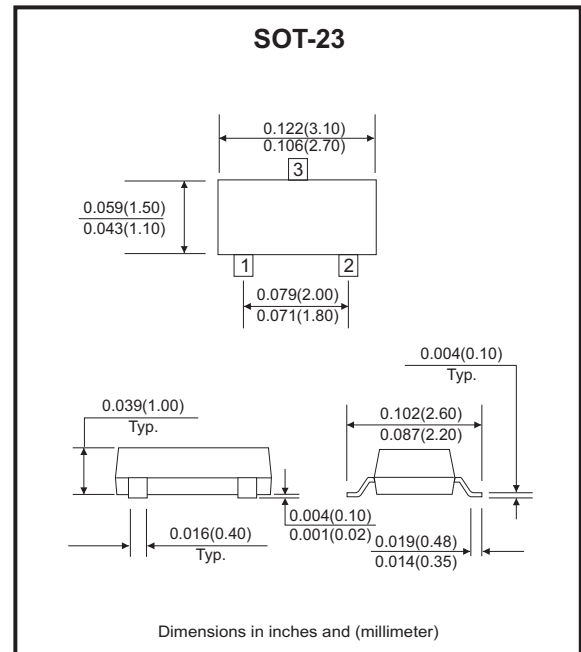
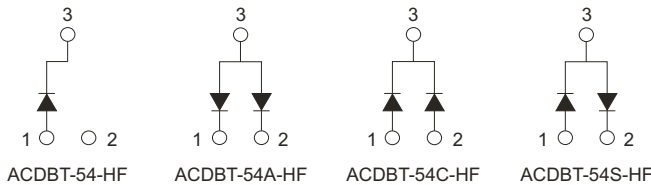

Maximum Ratings (at TA=25°C unless otherwise noted)

Parameter	Symbol	Conditions	Value	Unit
Peak repetitive peak reverse voltage	V_{RRM}		30	V
Working peak reverse voltage	V_{RWM}			
DC blocking voltage	V_R			
Forward continuous current	I_F		200	mA
Repetitive peak forward current	I_{FRM}		300	mA
Forward surge current	I_{FSM}	@ t<1.0s	600	mA
Power dissipation	P_D		200	mW
Thermal resistance	$R_{\theta JA}$	Junction to ambient air	500	°C/W
Operating and storage temperature	T_J, T_{STG}		-55 to +125	°C

Electrical Characteristics (at Ta=25°C unless otherwise noted)

Parameter	Symbol	Conditions	Min.	Typ.	Max.	Unit
Reverse breakdown voltage	$V_{(BR)}$	$I_R = 100\mu A$	30			V
Forward voltage	V_F	$I_F = 0.1mA$ $I_F = 1mA$ $I_F = 10mA$ $I_F = 30mA$ $I_F = 100mA$			0.24 0.32 0.40 0.50 1.00	V
Reverse current	I_R	$V_R = 25V$			2	μA
Diode capacitance	C_D	$V_R = 1V, f = 1.0MHz$			10	pF
Reverse recovery time	T_{rr}	$I_F = I_R = 10mA,$ $I_{RR} = 0.1 \times I_R, R_L = 100\Omega$			5	nS

RATING AND CHARACTERISTIC CURVES (ACDBT-54-HF Series)

Fig.1 - Forward Characteristics

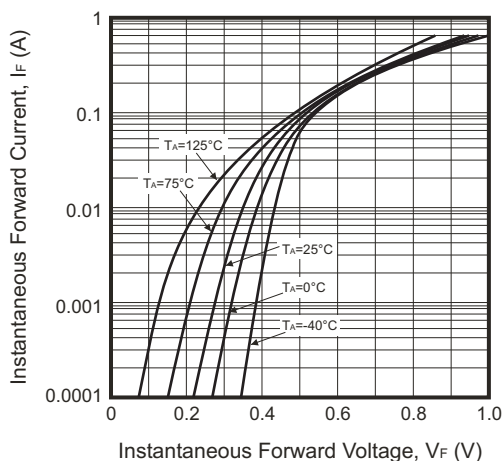

Fig.2 - Typical Reverse Characteristics

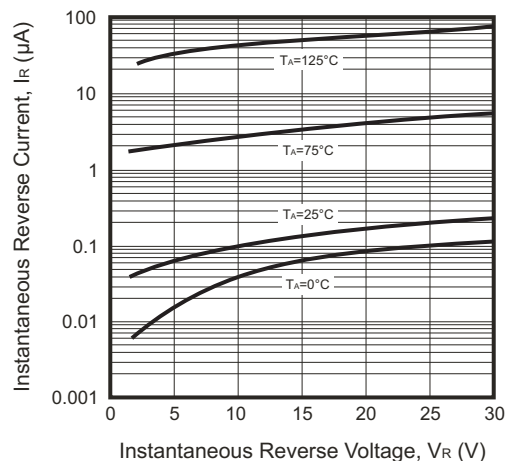

Fig.3 - Typical Capacitance v.s Reverse Voltage

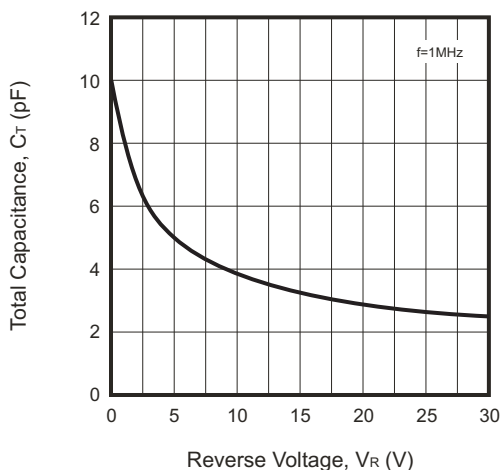
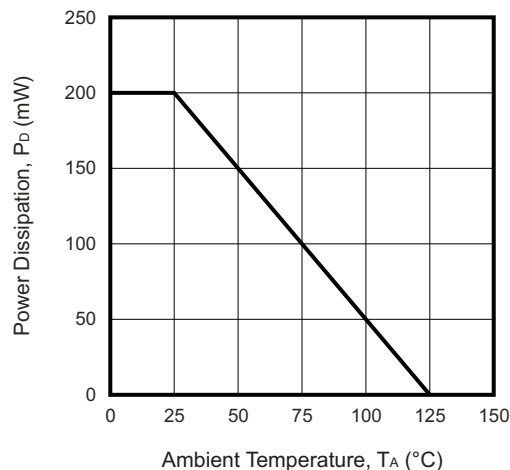

Fig.4 - Power Derating Curve



Company reserves the right to improve product design, functions and reliability without notice.

REV: C

Reel Taping Specification

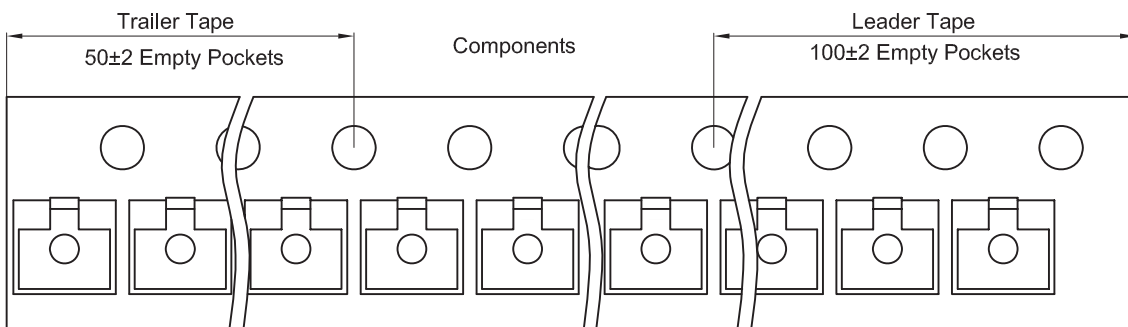
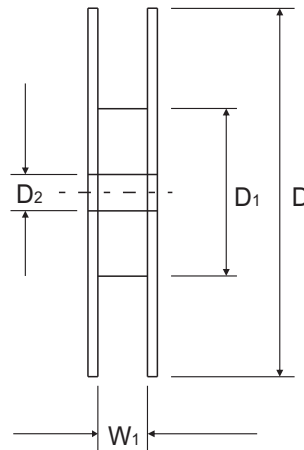
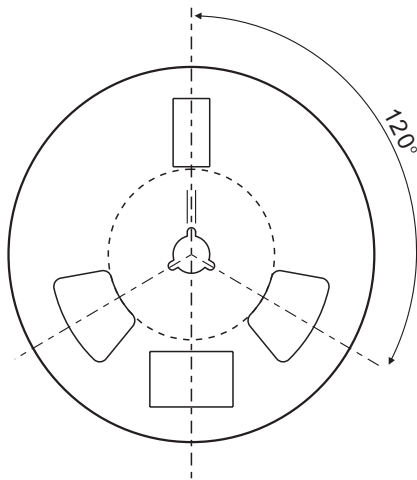
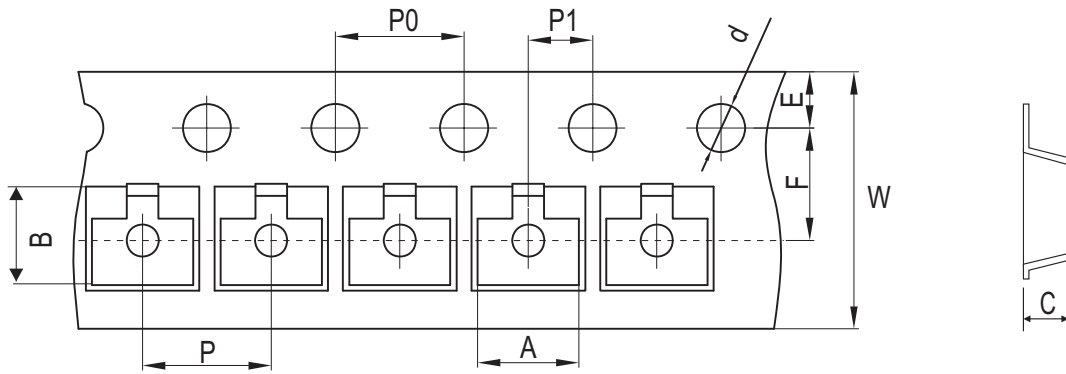

SOT-23	SYMBOL	A	B	C	d	D	D1	D2
	(mm)	3.15 ± 0.10	2.77 ± 0.10	1.22 ± 0.10	1.50 + 0.10	178.00 ± 1.00	54.00 ± 0.50	13.00 ± 0.50
	(inch)	0.124 ± 0.004	0.109 ± 0.004	0.048 ± 0.004	0.059 + 0.004	7.008 ± 0.039	2.126 ± 0.020	0.512 ± 0.020

SOT-23	SYMBOL	E	F	P	P0	P1	W	W1
	(mm)	1.75 ± 0.10	3.50 ± 0.05	4.00 ± 0.10	4.00 ± 0.10	2.00 ± 0.05	8.00 + 0.30 / - 0.10	9.50 ± 1.00
	(inch)	0.069 ± 0.004	0.138 ± 0.002	0.158 ± 0.004	0.158 ± 0.004	0.079 ± 0.002	0.315 + 0.012 / - 0.004	0.374 ± 0.039

Company reserves the right to improve product design, functions and reliability without notice.

REV: C

Marking Code

Part Number	Marking Code
ACDBT-54-HF	KL1
ACDBT-54A-HF	KL2
ACDBT-54C-HF	KL3
ACDBT-54S-HF	KL4

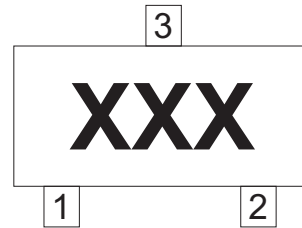

XXX = Product type marking code
Solid dot = Halogen free parts

Suggested PAD Layout

SIZE	SOT-23	
	(mm)	(inch)
A	0.90	0.035
B	0.80	0.031
C	1.90	0.075
D	2.00	0.079

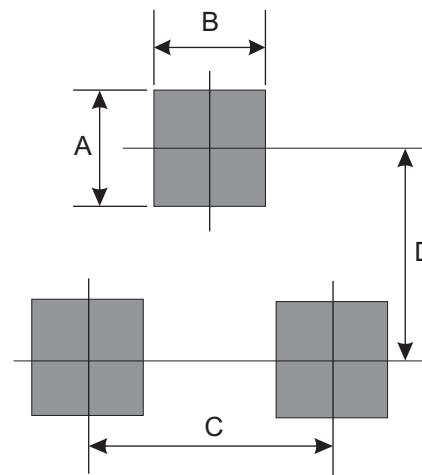

Note:
 1. The pad layout is for reference purposes only.

Standard Packaging

Case Type	REEL PACK	
	REEL (pcs)	Reel Size (inch)
SOT-23	3,000	7

X-ON Electronics

Largest Supplier of Electrical and Electronic Components

Click to view similar products for [Schottky Diodes & Rectifiers](#) category:

Click to view products by [Comchip](#) manufacturer:

Other Similar products are found below :

[MA4E2039](#) [D1FH3-5063](#) [MBR10100CT-BP](#) [MBR1545CT](#) [MMBD301M3T5G](#) [RB160M-50TR](#) [RB551V-30](#) [BAS16E6433HTMA1](#) [BAT](#)
[54-02LRH E6327](#) [NSR05F40QNXT5G](#) [NTE555](#) [JANS1N6640](#) [SB07-03C-TB-H](#) [SB1003M3-TL-W](#) [SK310-T](#) [SK32A-LTP](#) [SK33A-TP](#)
[SK34B-TP](#) [SS3003CH-TL-E](#) [GA01SHT18](#) [CRS10I30A\(TE85L,QM](#) [MA4E2501L-1290](#) [MBRA140TRPBF](#) [MBRB30H30CT-1G](#) [SB007-](#)
[03C-TB-E](#) [SK32A-TP](#) [SK33B-TP](#) [SK35A-TP](#) [SK38B-TP](#) [NRVBM120LT1G](#) [NTE505](#) [NTSB30U100CT-1G](#) [SS15E-TP](#) [VS-](#)
[6CWQ10FNHM3](#) [ACDBA1100LR-HF](#) [ACDBA1200-HF](#) [ACDBA140-HF](#) [ACDBA2100-HF](#) [ACDBA3100-HF](#) [CDBQC0530L-HF](#)
[CDBQC0240LR-HF](#) [ACDBA340-HF](#) [ACDBA260LR-HF](#) [ACDBA1100-HF](#) [SK310B-TP](#) [MA4E2502L-1246](#) [MA4E2502H-1246](#)
[NRVBM120ET1G](#) [NSR01L30MXT5G](#) [NTE573](#)