

ATV06A130-HF Thru. ATV06A400-HF

Working Peak Reverse Voltage: 13 to 40 Volts

Peak Pulse Power: 600 Watts

RoHS Device

Halogen Free

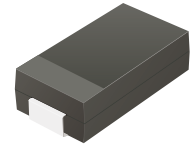

Features

- Glass passivated chip.
- Low leakage.
- 600W peak pulse power capability with a 10/1000 μ s waveform, repetitive rate (duty cycle): 0.01%.
- Uni and Bidirectional unit.
- Excellent clamping capability.
- Very fast response time.
- AEC-Q101 Qualified

Mechanical data

- Case: SMA/DO-214AC, molded plastic.
- Epoxy: UL 94V-0 rate flame retardant.
- Lead: Solderable per MIL-STD-750, method 2026.
- Polarity: Color band denotes cathode end except bipolar.
- Mounting position: Any.

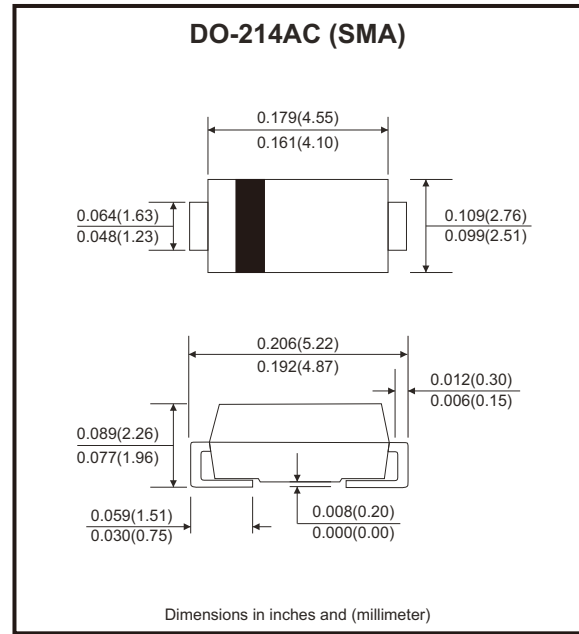

Circuit Diagram

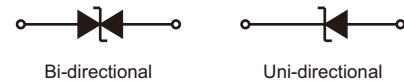

Maximum Ratings and Electrical Characteristics

Ratings at 25°C ambient temperature unless otherwise specified.
Single phase, half wave, 60Hz, resistive or inductive load.
For capacitive load, derate current by 20%.

Characteristics	Symbol	Value	Units
Peak power dissipation with a 10/1000 μ s waveform (Note 1)	P _{PP}	600	W
Peak pulse current with a 10/1000 μ s waveform (Note 1)	I _{PP}	See Next Table	A
Power dissipation on infinite heatsink at T _L =75°C	P _D	3.0	W
Peak forward surge current, 8.3ms single half sine-wave, uni-directional only (Note 2)	I _{FSM}	60	A
Maximum instantaneous forward voltage at 25A for uni-directional only	V _F	3.5	V
Operating junction temperature range	T _J	-55 to +150	°C
Storage temperature range	T _{STG}	-55 to +150	°C

Notes: 1. Non-repetitive current pulse per Fig.5 and derated above Ta=25°C per Fig.1

2. Measured on 8.3ms single half sine-wave or equivalent square wave, duty cycle = 4 pulses per minute maximum.

Company reserves the right to improve product design, functions and reliability without notice.

REV:A

Rating and Characteristic Curves (ATV06A130-HF Thru. ATV06A400-HF)

Fig.1 - Pulse Derating Curve

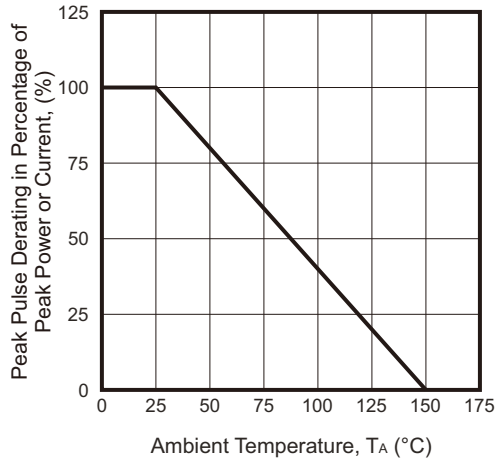

Fig.2 - Max. Non-repetitive Surge Current

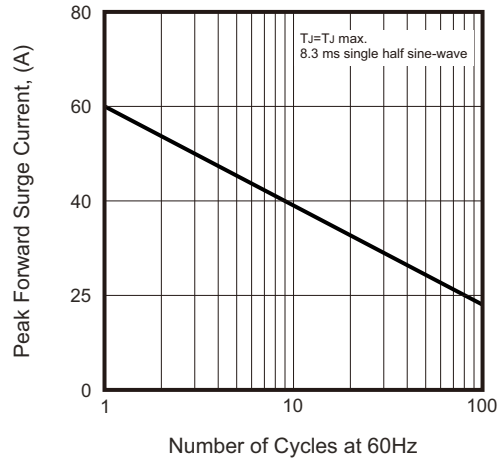

Fig.3 - Steady State Power Derating Curve

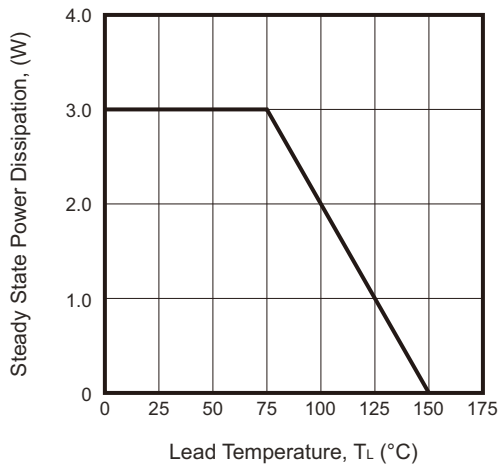

Fig.4 - Peak Pulse Power Rating Curve

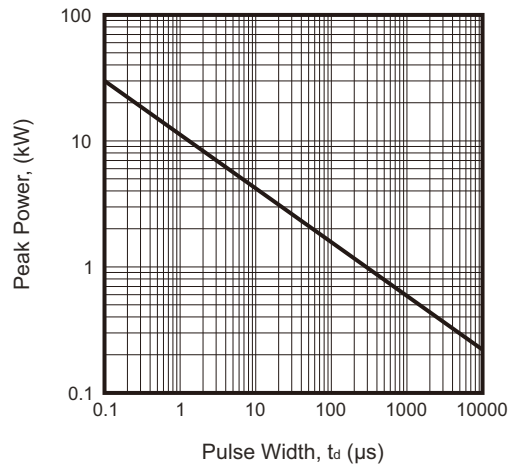

Fig.5 - Pulse Waveform

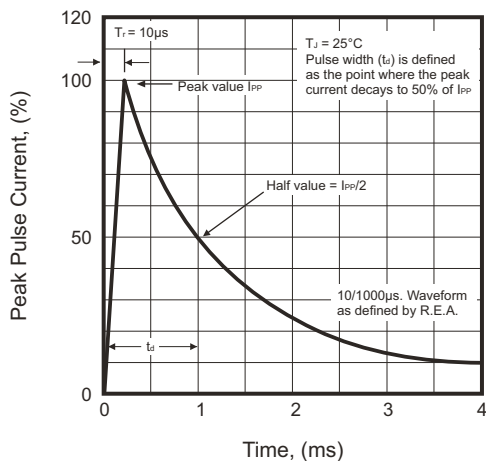
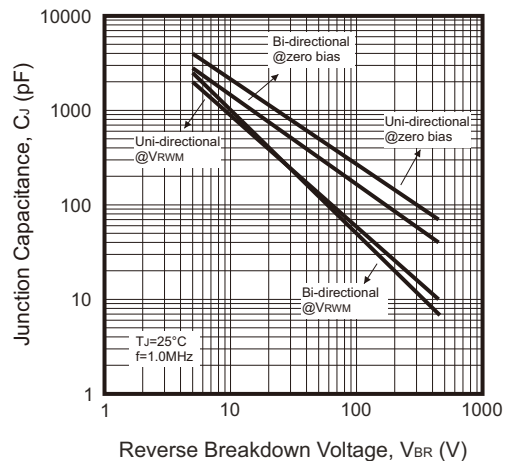

Fig.6 - Peak Pulse Power Rating Curve



SMD Transient Voltage Suppressor



Electrical Characteristics (ATV06A130-HF Thru. ATV06A400-HF)

Part No	Breakdown voltage V_{BR} @ I_T			Maximum Reverse Leakage @ V_{RWM}	Working Peak Reverse Voltage	Maximum Reverse Surge Current	Maximum Clamping Voltage @ I_{PP}	Marking Code	
	V_{BR} Min. (V)	V_{BR} Max. (V)	I_T (mA)	I_R (μ A)	V_{RWM} (V)	I_{PP} (A)	V_C (V)	UNI	BI
ATV06A130J(B)-HF	14.40	15.90	1	1	13.0	27.9	21.5	LGA	BGA
ATV06A140J(B)-HF	15.60	17.20	1	1	14.0	25.9	23.2	LKA	BKA
ATV06A150J(B)-HF	16.70	18.50	1	1	15.0	24.6	24.4	LMA	BMA
ATV06A160J(B)-HF	17.80	19.70	1	1	16.0	23.1	26.0	LPA	BPA
ATV06A170J(B)-HF	18.90	20.90	1	1	17.0	21.7	27.6	LRA	BRA
ATV06A180J(B)-HF	20.00	22.10	1	1	18.0	20.5	29.2	LTA	BTA
ATV06A190J(B)-HF	21.10	23.30	1	1	19.0	19.5	30.8	LBA	BBA
ATV06A200J(B)-HF	22.20	24.50	1	1	20.0	18.5	32.4	LVA	BVA
ATV06A220J(B)-HF	24.40	26.90	1	1	22.0	16.9	35.5	LXA	BXA
ATV06A240J(B)-HF	26.70	29.50	1	1	24.0	15.4	38.9	LZA	BZA
ATV06A260J(B)-HF	28.90	31.90	1	1	26.0	14.3	42.1	MEA	CEA
ATV06A280J(B)-HF	31.10	34.40	1	1	28.0	13.2	45.4	MGA	CGA
ATV06A300J(B)-HF	33.30	36.80	1	1	30.0	12.4	48.4	MKA	CKA
ATV06A330J(B)-HF	36.70	40.60	1	1	33.0	11.3	53.3	MMA	CMA
ATV06A360J(B)-HF	40.00	44.20	1	1	36.0	10.3	58.1	MPA	CPA
ATV06A400J(B)-HF	44.40	49.10	1	1	40.0	9.30	64.5	MRA	CRA

Notes: 1. Suffix B after part number to specify Bi-directional devices.

Reel Taping Specification

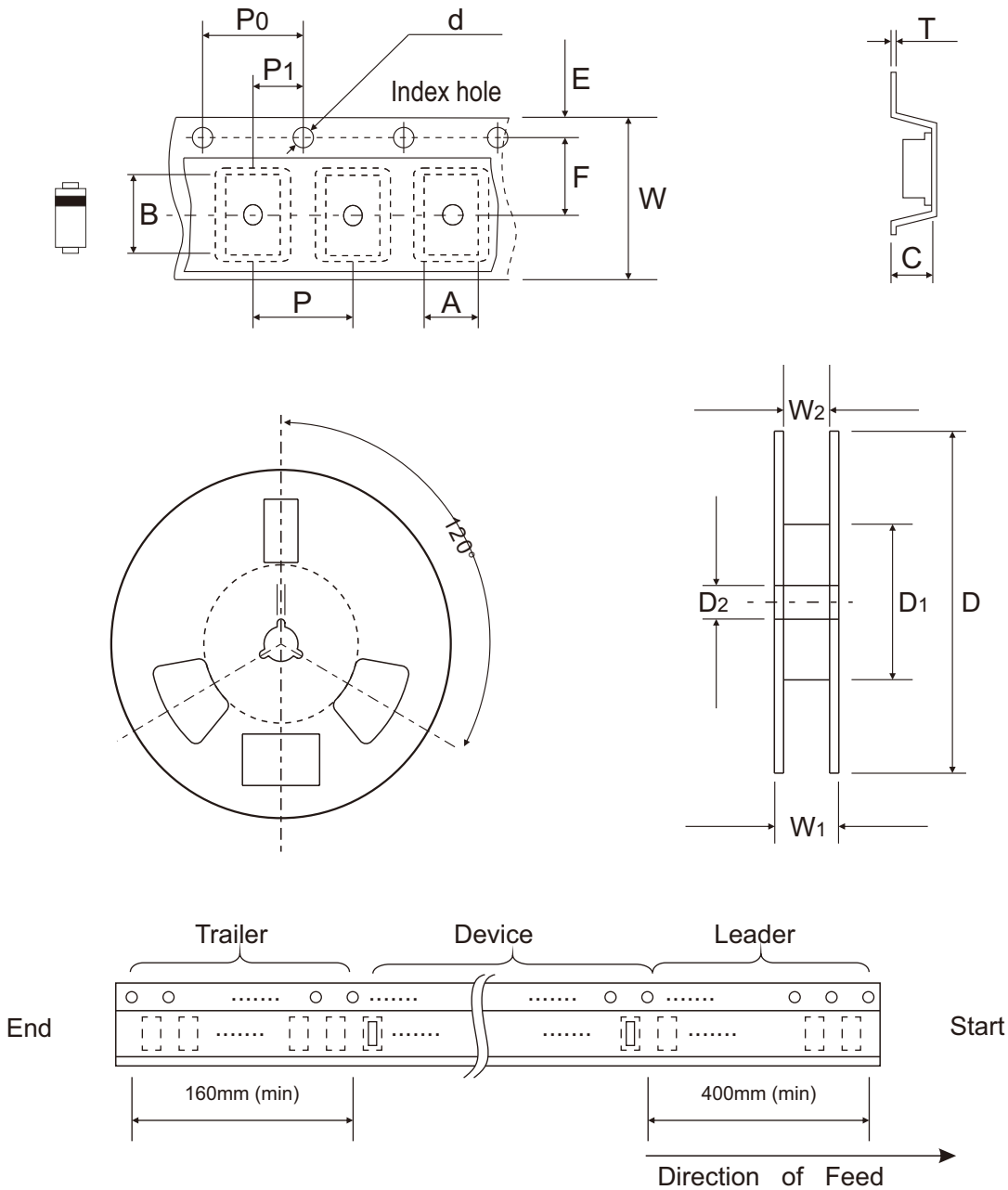

DO-214AC (SMA)	SYMBOL	A	B	C	d	D	D1	D2	E
	(mm)	See Note 1			1.55 ± 0.05	330.00	50.00 (Min.)	13.00 ± 0.50	1.75 ± 0.05
	(inch)	See Note 1			0.061 ± 0.002	12.992	1.969 (Min.)	0.512 ± 0.020	0.069 ± 0.002

DO-214AC (SMA)	SYMBOL	F	P	P0	P1	T	W	W1	W2
	(mm)	5.50 ± 0.05	4.00 ± 0.10	4.00 ± 0.10	2.00 ± 0.05	0.40 (Max.)	12.00 ± 0.10	18.40 (Max.)	14.40 (Max.)
	(inch)	0.217 ± 0.002	0.157 ± 0.004	0.157 ± 0.004	0.079 ± 0.002	0.016 (Max.)	0.472 ± 0.004	0.724 (Max.)	0.567 (Max.)

Notes: 1. A, B, and C the clearance between the component and the cavity must be within 0.5mm max. for 8mm tape and 12mm tape, 1.0mm max. for 16mm tape and 24mm tape.

Company reserves the right to improve product design, functions and reliability without notice.

REV:A

Marking Code

Part Number	Marking Code
ATV06A-HF Series	XXX



XXX = Marking code (See Page.3)

█ = Cathode band

Suggested PAD Layout

SIZE	DO-214AC(SMA)	
	(mm)	(inch)
A	1.88 MAX	0.074 MAX
B	1.52 MIN	0.060 MIN
C	1.68 MIN	0.066 MIN
D	5.28 REF	0.208 REF

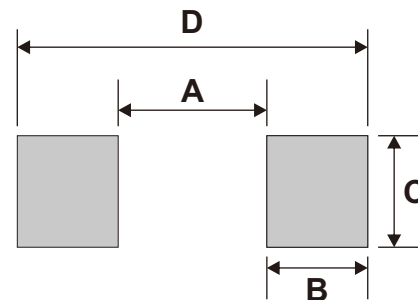

Note: 1.The pad layout is for reference purposes only.

Standard Packaging

Case Type	REEL PACK	
	REEL (pcs)	Reel Size (inch)
DO-214AC (SMA)	5,000	13

X-ON Electronics

Largest Supplier of Electrical and Electronic Components

Click to view similar products for [Comchip manufacturer](#):

Other Similar products are found below :

[1.5KE100A-HF](#) [1.5KE150A-G](#) [1.5KE15A-G](#) [1.5KE16A-G](#) [1.5KE18A-G](#) [1.5KE200A-G](#) [1.5KE220A-G](#) [1.5KE220CA-G](#) [1.5KE22CA-G](#)
[1.5KE24A-HF](#) [1.5KE27A-G](#) [1.5KE30A-G](#) [1.5KE33A-G](#) [1.5KE33CA-G](#) [1.5KE36A-G](#) [1.5KE36CA-G](#) [1.5KE43A-G](#) [1.5KE440A-HF](#)
[1.5KE47A-G](#) [1.5KE62A-G](#) [1.5KE6.8A-G](#) [1.5KE68A-G](#) [1N4001B-G](#) [1N4001-G](#) [1N4001T-G](#) [1N4002B-G](#) [1N4002-G](#) [1N4002T-G](#)
[1N4003B-G](#) [1N4003-G](#) [1N4003T-G](#) [1N4004B-G](#) [1N4004-G](#) [1N4004T-G](#) [1N4005-G](#) [1N4006B-G](#) [1N4006-G](#) [1N4007B-G](#) [1N4007-G](#)
[1N4007GP-HF](#) [1N4007T-G](#) [1N4148-G](#) [1N4148W-HF](#) [1N4148WS-HF](#) [1N4148WT-HF](#) [1N5400-G](#) [1N5401-G](#) [1N5401T-G](#) [1N5402-G](#)
[1N5404-G](#)