

## BR10005SG-G Thru. BR1010SG-G

Reverse Voltage: 50 to 1000V

Forward Current: 10.0A

RoHS Device

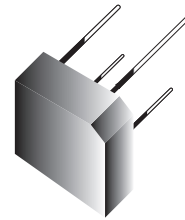

### Features

- Low forward voltage drop.
- Small size ; simple installation.
- Silver plated copper leads.
- Surge overload rating -175 amperes peak.
- UL recognized file # E349301

### Mechanical Data

- Polarity: As marked on Body.
- Mounting position: Any.
- Weight: 3.61 grams.

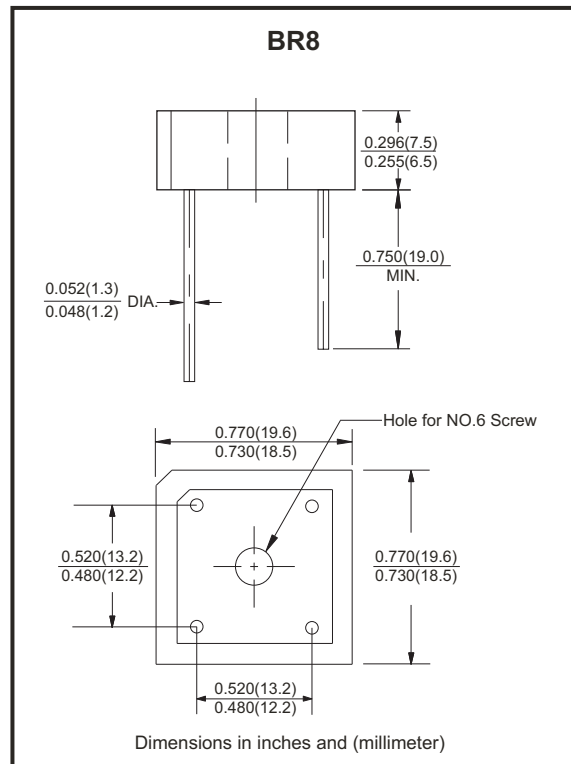

### Maximum ratings and electrical characteristics

Rating at 25°C ambient temperature unless otherwise specified.  
Single phase, half wave, 60Hz, resistive or inductive load.  
For capacitive load, derate current by 20%

Parameter	Symbol	BR10005 SG-G	BR1001 SG-G	BR1002 SG-G	BR1004 SG-G	BR1006 SG-G	BR1008 SG-G	BR1010 SG-G	Unit
Maximum Recurrent Peak Reverse Voltage	$V_{RRM}$	50	100	200	400	600	800	1000	V
Maximum RMS Bridge Input Voltage	$V_{RMS}$	35	70	140	280	420	560	700	V
Maximum DC Blocking Voltage	$V_{DC}$	50	100	200	400	600	800	1000	V
Maximum Average Forward Rectified Output Current at $T_A=50^\circ\text{C}$	$I_{(AV)}$	10.0							A
Peak Forward Surge Current, 8.3ms Single Half Sine-Wave Super Imposed On Rated Load	$I_{FSM}$	175							A
Maximum Forward Voltage Drop Per Bridge Element at 5.0A Peak	$V_F$	1.1							V
Maximum Reverse Current at Rate $T_J=25^\circ\text{C}$ DC Blocking Voltage Per Element $T_J=100^\circ\text{C}$	$I_R$	10.0							$\mu\text{A}$
		1.0							mA
Operating Temperature Range	$T_J$	-55 to +150							$^\circ\text{C}$
Storage Temperature Range	$T_{STG}$	-55 to +150							$^\circ\text{C}$

Notes:

- Unit mounted on metal chassis.
- Unit mounted on P.C.B.

Company reserves the right to improve product design , functions and reliability without notice.

REV: B

## Rating and Characteristics Curves (BR10005SG-G Thru. BR1010SG-G)

Fig.1 - Derating Curve Output Rectified Current

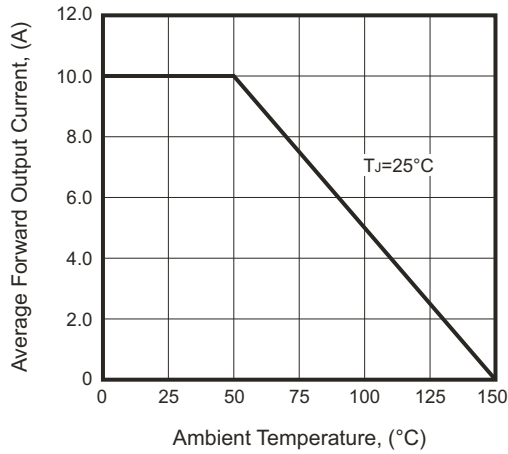

Fig.2 - Maximum Forward Surge Current

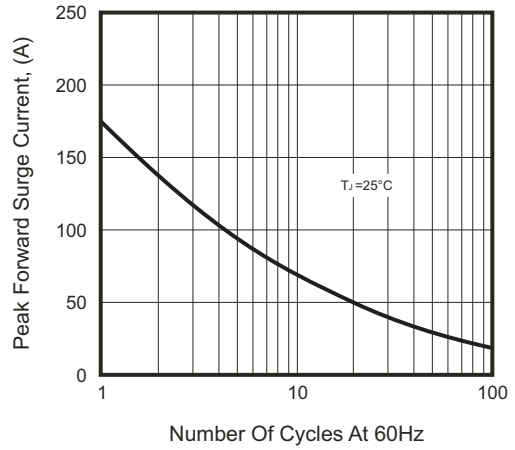

Fig.3 - Typical Forward Characteristics

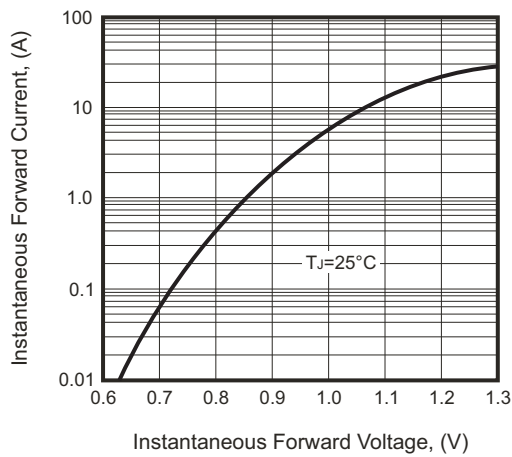
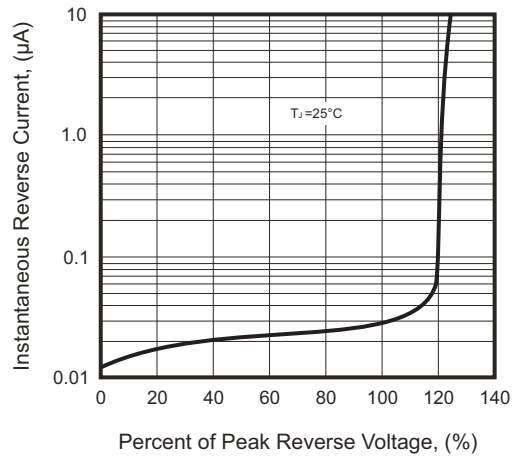
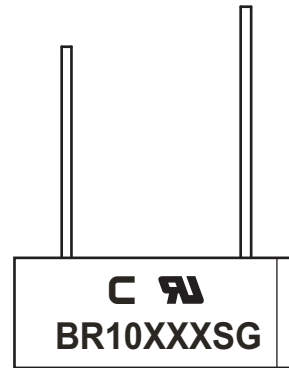

Fig.4 - Typical Reverse Characteristics



## Marking Code

Part Number	Marking code
BR10005SG-G	BR10005SG
BR1001SG-G	BR1001SG
BR1002SG-G	BR1002SG
BR1004SG-G	BR1004SG
BR1006SG-G	BR1006SG
BR1008SG-G	BR1008SG
BR1010SG-G	BR1010SG



XX / XXX = Product type marking code

C = Comchip Logo

## Standard Packaging

Case Type	BULK PACK	
	BOX ( pcs )	CARTON ( pcs )
BR8	200	2,000

## X-ON Electronics

Largest Supplier of Electrical and Electronic Components

*Click to view similar products for [Bridge Rectifiers](#) category:*

*Click to view products by [Comchip](#) manufacturer:*

Other Similar products are found below :

[MB2510](#) [MB252](#) [MB356G](#) [MB358G](#) [90MT160KPBF](#) [GBJ1504-BP](#) [GBU15J-BP](#) [GBU15K-BP](#) [GBU4A-BP](#) [GBU4D-BP](#) [GBU6B-E3/45](#)  
[GSIB680-E3/45](#) [DB101-BP](#) [DF01](#) [DF10SA-E345](#) [KBPC50-10S](#) [RS405GL-BP](#) [G5SBA60-E3/51](#) [GBU10J-BP](#) [GBU6M](#) [GBU8D-BP](#)  
[GBU8J-BP](#) [GSIB1520-E3/45](#) [36MB140A](#) [TB102M](#) [MB1510](#) [MB258](#) [MB6M-G](#) [MB86](#) [TL401G](#) [MDA920A2](#) [TU602](#) [TU810](#) [BR1005-BP](#)  
[BR101-BP](#) [BR84DTP204](#) [BU2008-E3/51](#) [36MB100A](#) [KBPC10/15/2501WP](#) [KBPC25-02](#) [VS-2KBB60](#) [DF06SA-E345](#) [DF1510S](#) [VS-](#)  
[40MT160PAPBF](#) [W02M](#) [GBL02-E3/45](#) [GBU4G-BP](#) [GBJ2506-BP](#) [GBU6B-E3/51](#) [GSIB15A80-E3/45](#)