

CDBFR0320/0330/0340-HF

$I_o = 350 \text{ mA}$

$V_R = 20 \text{ to } 40 \text{ Volts}$

RoHS Device

Halogen Free

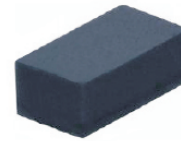

Features

- Low forward voltage.
- Designed for mounting on small surface.
- Extremely thin / leadless package.
- Majority carrier conduction.

Mechanical data

- Case: 1005/SOD-323F standard package, molded plastic.
- Terminals: Gold plated, solderable per MIL-STD-750, method 2026
- Polarity: Indicated by cathode band.
- Mounting position: Any
- Weight: 0.006 grams(approx.).

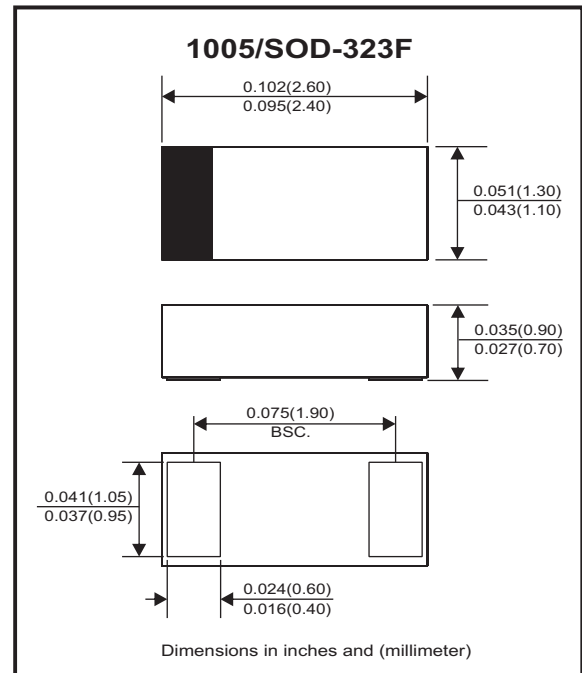

Circuit Diagram



Maximum Rating (at $T_A=25^\circ\text{C}$ unless otherwise noted)

Parameter	Symbol	CDBFR0320-HF	CDBFR0330-HF	CDBFR0340-HF	Unit
Repetitive Peak reverse voltage	V_{RRM}	20	30	40	V
Reverse voltage	V_R	20	30	40	V
RMS reverse voltage	$V_{R(MS)}$	14	21	28	V
Average forward rectified current	I_o	350			mA
Peak forward surge current 8.3 ms single half sine-wave	I_{FSM}	1.5			A
Power dissipation	P_D	200			mA
Thermal resistance junction to ambient air	$R_{\theta JA}$	500			$^\circ\text{C}/\text{W}$
Junction temperature	T_j	+125			$^\circ\text{C}$
Storage temperature range	T_{STG}	-65 to +125			$^\circ\text{C}$

Electrical Characteristics (at $T_A=25^\circ\text{C}$ unless otherwise noted)

Parameter	Conditions	Symbol	Min	Typ	Max	Unit
Reverse current	$V_R = 10\text{V}$ $V_R = 20\text{V}$ $V_R = 30\text{V}$	I_R			5 5 5	μA
Forward voltage	$I_F = 20\text{mA}$ $I_F = 200\text{mA}$	V_F			0.37 0.60	V
Capacitance between terminals	$f = 1 \text{ MHz}$, and 0V DC reverse voltage	C_T		50		pF
Reverse recovery time	$I_F = I_R$, $I_{rr} = 0.1X I_R$, $R_L = 100 \text{ ohm}$	T_{rr}		6.4		nS

RATING AND CHARACTERISTIC CURVES (CDBFR0320/0330/0340-HF)

Fig. 1 - Forward Characteristics

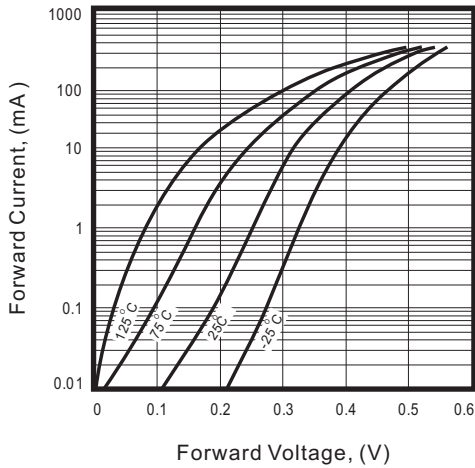

Fig. 2 - Reverse Characteristics

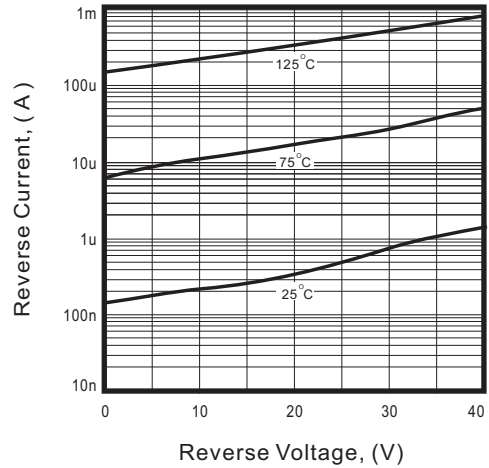

Fig.3 - Capacitance Between Terminals Characteristics

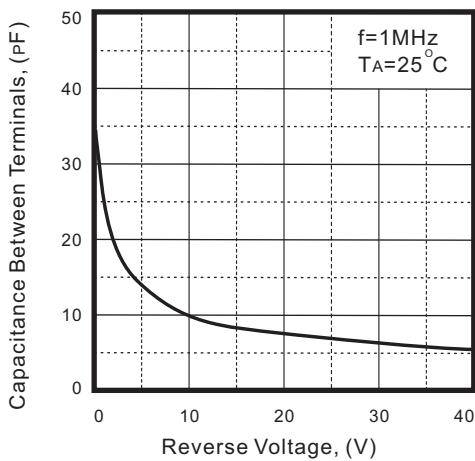
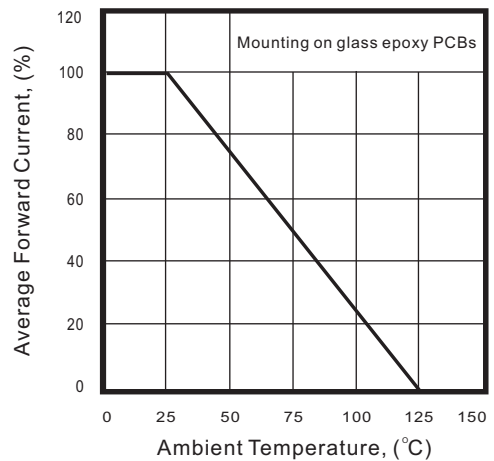
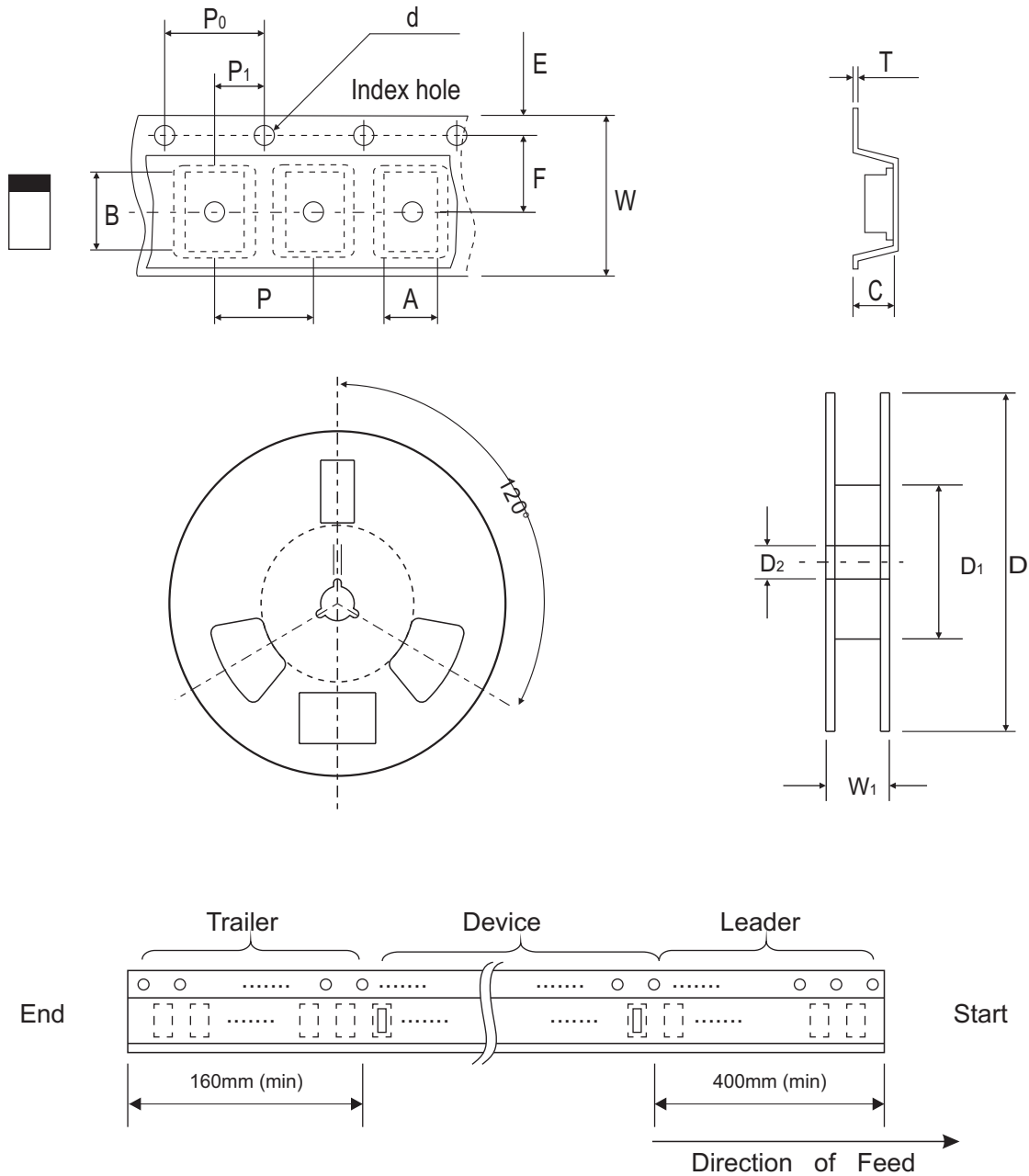

Fig.4 - Current Derating Curve



Reel Taping Specification



1005 (SOD-323F)	SYMBOL	A	B	C	d	D	D ₁	D ₂
	(mm)	1.45 ± 0.05	2.80 ± 0.05	1.00 ± 0.05	1.50 + 0.10 - 0	178.00 ± 1.00	60.0 ± 0.50	13.50 ± 0.20
	(inch)	0.057 ± 0.002	0.110 ± 0.002	0.039 ± 0.002	0.059 + 0.004 - 0	7.008 ± 0.039	2.362 ± 0.020	0.531 ± 0.008

1005 (SOD-323F)	SYMBOL	E	F	P	P ₀	P ₁	T	W	W ₁
	(mm)	1.75 ± 0.10	3.50 ± 0.05	4.00 ± 0.10	4.00 ± 0.10	2.00 ± 0.05	0.23 ± 0.05	8.00 ± 0.10	12.00 + 0.50 - 0
	(inch)	0.069 ± 0.004	0.138 ± 0.002	0.157 ± 0.004	0.157 ± 0.004	0.079 ± 0.002	0.009 ± 0.002	0.315 ± 0.004	0.472 + 0.020 - 0

Marking Code

Part Number	Marking Code
CDBFR0320-HF	BH
CDBFR0330-HF	BJ
CDBFR0340-HF	BK



xx = Product type marking code

Suggested PAD Layout

SIZE	1005/SOD-323F	
	(mm)	(inch)
A	2.00	0.079
B	0.70	0.028
C	1.30	0.051
D	2.70	0.106
E	1.30	0.051

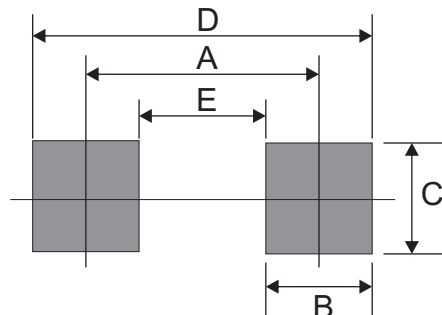

Standard Packaging

Case Type	Qty Per Reel	Reel Size
	(Pcs)	(inch)
1005/SOD-323F	4,000	7

X-ON Electronics

Largest Supplier of Electrical and Electronic Components

Click to view similar products for [Schottky Diodes & Rectifiers](#) category:

Click to view products by [Comchip](#) manufacturer:

Other Similar products are found below :

[MA4E2039](#) [D1FH3-5063](#) [MBR10100CT-BP](#) [MBR1545CT](#) [MMBD301M3T5G](#) [RB160M-50TR](#) [RB551V-30](#) [BAS16E6433HTMA1](#) [BAT](#)
[54-02LRH E6327](#) [NSR05F40QNXT5G](#) [NTE555](#) [JANS1N6640](#) [SB07-03C-TB-H](#) [SB1003M3-TL-W](#) [SK310-T](#) [SK32A-LTP](#) [SK33A-TP](#)
[SK34B-TP](#) [SS3003CH-TL-E](#) [GA01SHT18](#) [CRS10I30A\(TE85L,QM](#) [MA4E2501L-1290](#) [MBRA140TRPBF](#) [MBRB30H30CT-1G](#) [SB007-](#)
[03C-TB-E](#) [SK32A-TP](#) [SK33B-TP](#) [SK35A-TP](#) [SK38B-TP](#) [NRVBM120LT1G](#) [NTE505](#) [NTSB30U100CT-1G](#) [SS15E-TP](#) [VS-](#)
[6CWQ10FNHM3](#) [ACDBA1100LR-HF](#) [ACDBA1200-HF](#) [ACDBA140-HF](#) [ACDBA2100-HF](#) [ACDBA3100-HF](#) [CDBQC0530L-HF](#)
[CDBQC0240LR-HF](#) [ACDBA340-HF](#) [ACDBA260LR-HF](#) [ACDBA1100-HF](#) [SK310B-TP](#) [MA4E2502L-1246](#) [MA4E2502H-1246](#)
[NRVBM120ET1G](#) [NSR01L30MXT5G](#) [NTE573](#)