

## CDBQC0130L-HF

**$I_o = 100 \text{ mA}$**   
 **$V_R = 30 \text{ Volts}$**   
**RoHS Device**  
**Halogen Free**



### Features

- Low forward voltage.
- Designed for mounting on small surface.
- Extremely thin package.
- Majority carrier conduction.

### Mechanical data

- Case: 0402C/SOD-923F standard package, molded plastic.
- Terminals: Matte tin plated, solderable per MIL-STD-750, method 2026.
- Polarity: Cathode band & BP
- Mounting position: Any
- Weight: 0.001 grams(approx.).

### Circuit Diagram

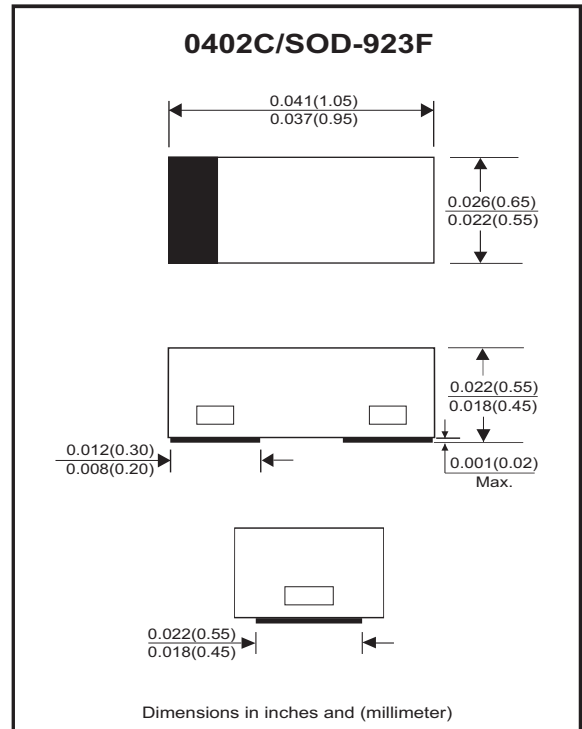

### Maximum Rating (at $T_A=25^\circ\text{C}$ unless otherwise noted)

Parameter	Conditions	Symbol	Min	Typ	Max	Unit
Repetitive Peak reverse voltage		$V_{RRM}$			35	V
Reverse voltage		$V_R$			30	V
Average forward rectified current		$I_o$			100	mA
Peak forward surge current	8.3 ms single half sine-wave (1 cyc)	$I_{FSM}$			3	A
Thermal resistance	Junction to ambient	$R_{\theta JA}$		200		$^\circ\text{C}/\text{W}$
Junction temperature range		$T_j$	-40		+125	$^\circ\text{C}$
Storage temperature range		$T_{STG}$	-40		+125	$^\circ\text{C}$

### Electrical Characteristics (at $T_A=25^\circ\text{C}$ unless otherwise noted)

Parameter	Conditions	Symbol	Min	Typ	Max	Unit
Forward voltage	$I_F = 10\text{mA}$	$V_F$		0.25	0.30	V
Reverse current	$V_R = 10\text{V}$	$I_R$			10	$\mu\text{A}$
Capacitance between terminals	$V_R = 1\text{V}, f = 1 \text{ MHz}$	$C_T$		14	20	pF

## RATING AND CHARACTERISTIC CURVES (CDBQC0130L-HF)

Fig.1 - Forward characteristics

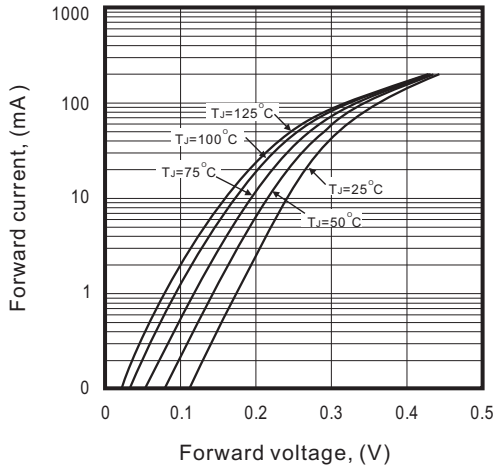

Fig.2 - Reverse characteristics

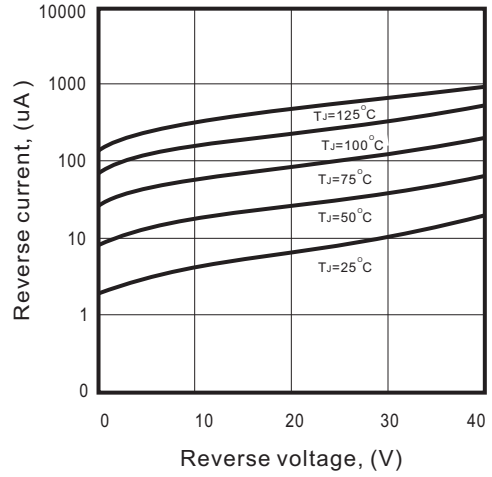

Fig.3 - Typical capacitance between terminals characteristics

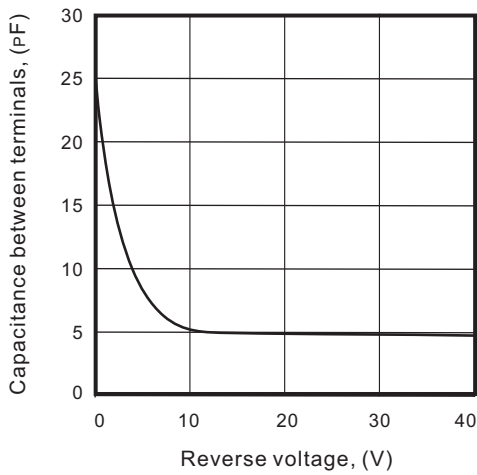
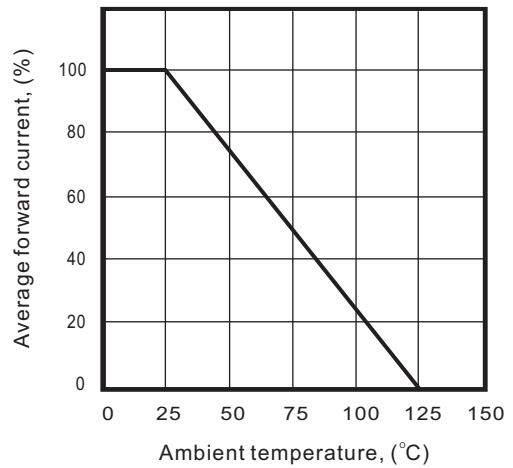
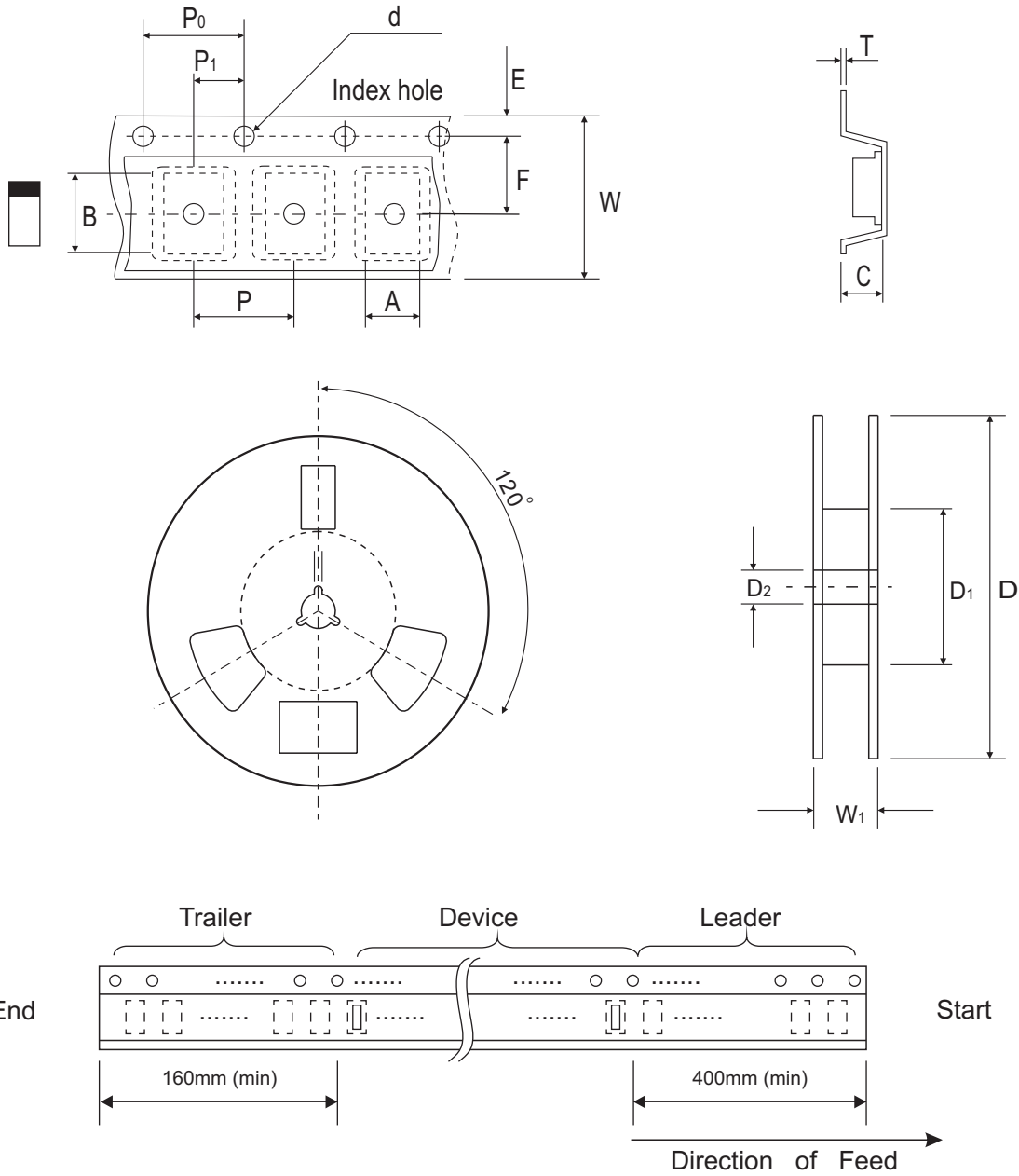

Fig.4 - Current derating curve



## Reel Taping Specification



0402C (SOD-923F)	SYMBOL	A	B	C	d	D	D <sub>1</sub>	D <sub>2</sub>
	(mm)	0.75 ± 0.05	1.17 ± 0.05	0.65 ± 0.05	1.50 + 0.10 - 0	178.00 ± 1.00	60.00 ± 0.50	13.50 ± 0.20
	(inch)	0.030 ± 0.002	0.046 ± 0.002	0.026 ± 0.002	0.059 + 0.004 - 0	7.008 ± 0.039	2.362 ± 0.020	0.531 ± 0.008

0402C (SOD-923F)	SYMBOL	E	F	P	P <sub>0</sub>	P <sub>1</sub>	T	W	W <sub>1</sub>
	(mm)	1.75 ± 0.10	3.50 ± 0.10	4.00 ± 0.10	4.00 ± 0.10	2.00 ± 0.10	0.20 + 0.02 - 0.05	8.00 ± 0.20	12.00 + 0.50 - 0
	(inch)	0.069 ± 0.004	0.138 ± 0.004	0.157 ± 0.004	0.157 ± 0.004	0.079 ± 0.004	0.008 + 0.001 - 0.002	0.315 ± 0.008	0.472 + 0.020 - 0

Company reserves the right to improve product design, functions and reliability without notice.

REV:B

## Marking Code

Part Number	Marking Code
CDBQC0130L-HF	BP



## Suggested PAD Layout

SIZE	0402C/SOD-923F	
	(mm)	(inch)
A	0.70	0.028
B	0.40	0.016
C	0.70	0.028
D	1.10	0.043
E	0.30	0.012

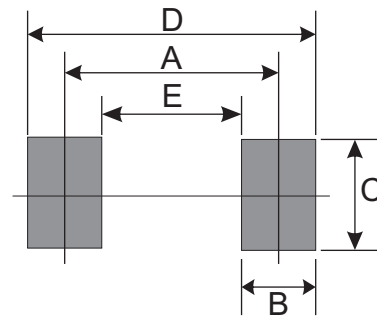

## Standard Packaging

Case Type	REEL PACK	
	REEL ( pcs )	Reel Size (inch)
0402C/SOD-923F	5,000	7

## X-ON Electronics

Largest Supplier of Electrical and Electronic Components

*Click to view similar products for [Schottky Diodes & Rectifiers](#) category:*

*Click to view products by [Comchip](#) manufacturer:*

Other Similar products are found below :

[MA4E2039](#) [D1FH3-5063](#) [MBR10100CT-BP](#) [MBR1545CT](#) [MMBD301M3T5G](#) [RB160M-50TR](#) [RB551V-30](#) [BAS16E6433HTMA1](#) [BAT](#)  
[54-02LRH E6327](#) [NSR05F40QNXT5G](#) [NTE555](#) [JANS1N6640](#) [SB07-03C-TB-H](#) [SK310-T](#) [SK32A-LTP](#) [SK33A-TP](#) [SK34B-TP](#) [SS3003CH-](#)  
[TL-E](#) [GA01SHT18](#) [CRS10I30A\(TE85L,QM](#) [MA4E2501L-1290](#) [MBRA140TRPBF](#) [MBRB30H30CT-1G](#) [SB007-03C-TB-E](#) [SK32A-TP](#)  
[SK33B-TP](#) [SK35A-TP](#) [SK38B-TP](#) [NRVBM120LT1G](#) [NTE505](#) [NTSB30U100CT-1G](#) [SS15E-TP](#) [VS-6CWQ10FNHM3](#) [ACDBA1100LR-HF](#)  
[ACDBA1200-HF](#) [ACDBA140-HF](#) [ACDBA2100-HF](#) [ACDBA3100-HF](#) [CDBQC0530L-HF](#) [CDBQC0240LR-HF](#) [BAT6202VH6327XTSA1](#)  
[ACDBA340-HF](#) [ACDBA260LR-HF](#) [ACDBA1100-HF](#) [SK310B-TP](#) [MA4E2502L-1246](#) [MA4E2502H-1246](#) [NRVBM120ET1G](#)  
[NSR01L30MXT5G](#) [NTE573](#)