

CDBU0230-HF

$I_o = 200 \text{ mA}$
 $V_R = 30 \text{ Volts}$
RoHS Device
Halogen Free



Features

- Designed for mounting on small surface.
- Extremely thin/leadless package.
- Low drop-down voltage.
- Majority carrier conduction.

Mechanical data

- Case: 0603/SOD-523F standard package, molded plastic.
- Terminals: Gold plated, solderable per MIL-STD-750, method 2026.
- Marking code: cathode band & B5
- Mounting position: Any
- Weight: 0.003 gram (approx.).

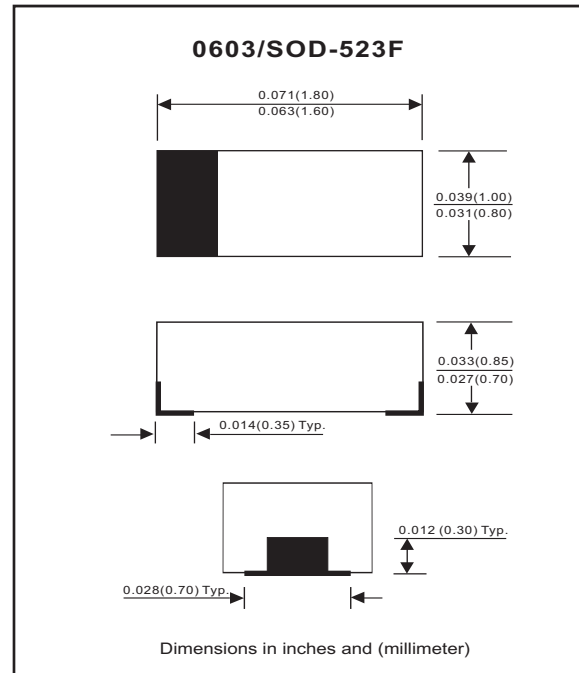

Maximum Rating (at $T_A=25^\circ\text{C}$ unless otherwise noted)

| Parameter | Conditions | Symbol | Min | Typ | Max | Unit |
|---------------------------------|---|-----------|-----|------|------|------------------|
| Repetitive peak reverse voltage | | V_{RRM} | | | 35 | V |
| Reverse voltage | | V_R | | | 30 | V |
| Average forward current | | I_o | | | 200 | mA |
| Forward current, surge peak | 8.3 ms single half sine-wave superimposed on rate load (JEDEC method) | I_{FSM} | | 3000 | | mA |
| Power Dissipation | | P_D | | | 150 | mW |
| Storage temperature | | T_{STG} | -40 | | +125 | $^\circ\text{C}$ |
| Junction temperature | | T_j | | | +125 | $^\circ\text{C}$ |

Electrical Characteristics (at $T_A=25^\circ\text{C}$ unless otherwise noted)

| Parameter | Conditions | Symbol | Min | Typ | Max | Unit |
|-------------------------------|--|--------|-----|-----|------|---------------|
| Forward voltage | $I_F = 200 \text{ mA DC}$ | V_F | | | 0.50 | V |
| Reverse current | $V_R = 30\text{V}$ | I_R | | | 30 | μA |
| Capacitance between terminals | $F = 1 \text{ MHz}$ and 10 VDC reverse voltage | C_T | | 9 | | pF |

RATING AND CHARACTERISTIC CURVES (CDBU0230-HF)

Fig. 1 - Forward characteristics

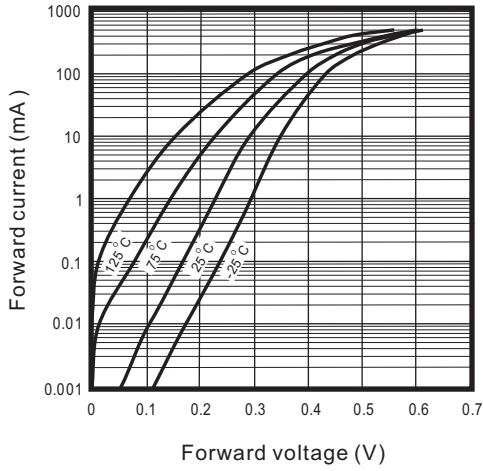

Fig. 2 - Reverse characteristics

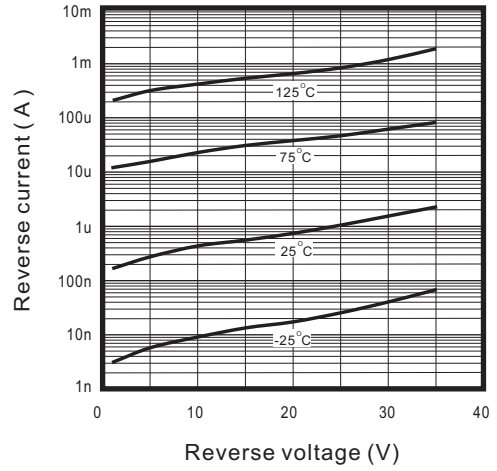

Fig.3 - Capacitance between terminals characteristics

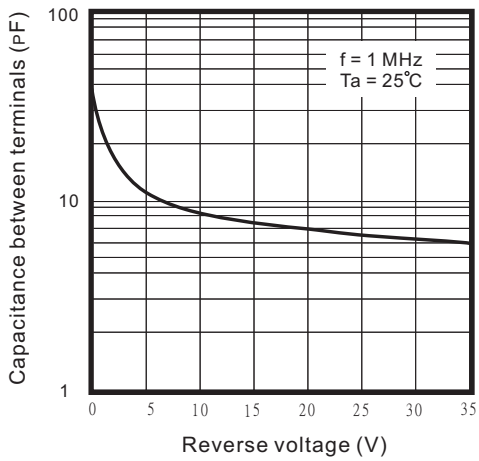
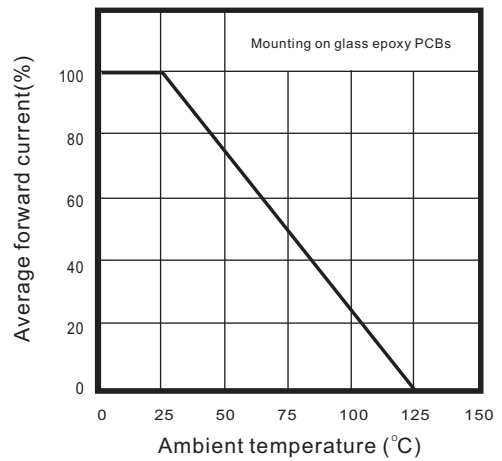
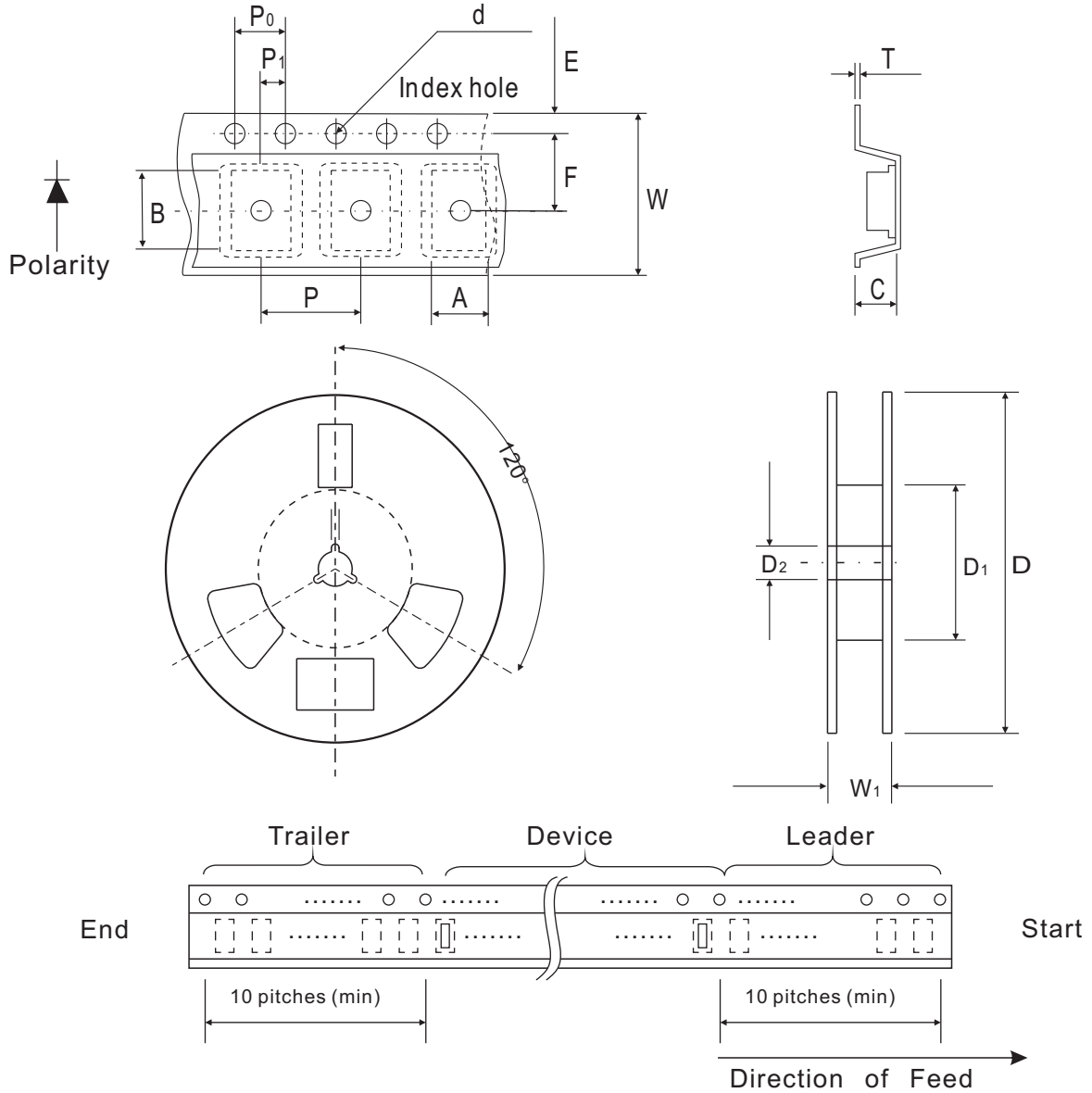

Fig.4 - Current derating curve



Reel Taping Specification



| 0603 (SOD-523F) | SYMBOL | A | B | C | d | D | D ₁ | D ₂ |
|--------------------|--------|---------------|---------------|---------------|---------------|--------------|----------------|----------------|
| | (mm) | 1.00 ± 0.10 | 1.85 ± 0.10 | 1.00 ± 0.10 | 1.55 ± 0.05 | 178 ± 1 | 60.0 MIN. | 13.0 ± 0.20 |
| | (inch) | 0.039 ± 0.004 | 0.073 ± 0.004 | 0.039 ± 0.004 | 0.061 ± 0.002 | 7.008 ± 0.04 | 2.362 MIN. | 0.512 ± 0.008 |

| 0603 (SOD-523F) | SYMBOL | E | F | P | P ₀ | P ₁ | T | W | W ₁ |
|--------------------|--------|---------------|---------------|---------------|----------------|----------------|---------------|---------------|----------------|
| | (mm) | 1.75 ± 0.10 | 3.50 ± 0.05 | 4.00 ± 0.10 | 4.00 ± 0.10 | 2.00 ± 0.05 | 0.23 ± 0.05 | 8.00 ± 0.20 | 13.5 MAX. |
| | (inch) | 0.069 ± 0.004 | 0.138 ± 0.002 | 0.157 ± 0.004 | 0.157 ± 0.004 | 0.079 ± 0.004 | 0.009 ± 0.002 | 0.315 ± 0.008 | 0.531 MAX. |

Marking Code

| Park Number | Marking Code |
|-------------|--------------|
| CDBU0230-HF | B5 |



Suggested PAD Layout

| SIZE | 0603/SOD-523F | |
|------|---------------|--------|
| | (mm) | (inch) |
| A | 1.70 | 0.067 |
| B | 0.60 | 0.024 |
| C | 0.80 | 0.031 |
| D | 2.30 | 0.091 |
| E | 1.10 | 0.043 |

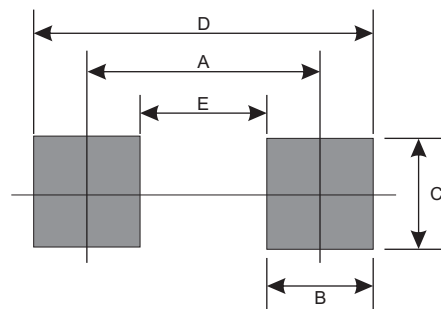

Standard Package

| Case Type | Qty per Reel | Reel Size |
|---------------|--------------|-----------|
| | (Pcs) | (inch) |
| 0603/SOD-523F | 4000 | 7 |

X-ON Electronics

Largest Supplier of Electrical and Electronic Components

Click to view similar products for [Schottky Diodes & Rectifiers](#) category:

Click to view products by [Comchip](#) manufacturer:

Other Similar products are found below :

[MA4E2039](#) [D1FH3-5063](#) [MBR10100CT-BP](#) [MBR1545CT](#) [MMBD301M3T5G](#) [RB160M-50TR](#) [RB551V-30](#) [BAS16E6433HTMA1](#) [BAT](#)
[54-02LRH E6327](#) [NSR05F40QNXT5G](#) [NTE555](#) [JANS1N6640](#) [SB07-03C-TB-H](#) [SK310-T](#) [SK32A-LTP](#) [SK33A-TP](#) [SK34B-TP](#) [SS3003CH-](#)
[TL-E](#) [GA01SHT18](#) [CRS10I30A\(TE85L,QM](#) [MA4E2501L-1290](#) [MBRA140TRPBF](#) [MBRB30H30CT-1G](#) [SB007-03C-TB-E](#) [SK32A-TP](#)
[SK33B-TP](#) [SK35A-TP](#) [SK38B-TP](#) [NRVBM120LT1G](#) [NTE505](#) [NTSB30U100CT-1G](#) [SS15E-TP](#) [VS-6CWQ10FNHM3](#) [ACDBA1100LR-HF](#)
[ACDBA1200-HF](#) [ACDBA140-HF](#) [ACDBA2100-HF](#) [ACDBA3100-HF](#) [CDBQC0530L-HF](#) [CDBQC0240LR-HF](#) [BAT6202VH6327XTSA1](#)
[ACDBA340-HF](#) [ACDBA260LR-HF](#) [ACDBA1100-HF](#) [SK310B-TP](#) [MA4E2502L-1246](#) [MA4E2502H-1246](#) [NRVBM120ET1G](#)
[NSR01L30MXT5G](#) [NTE573](#)