

## CDBW46-G

Reverse Voltage: 100 Volts

Forward Current: 150 mA

RoHS Device

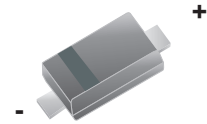

### Features

- Design for mounting on small surface.
- High breakdown voltage.
- Low trun-on voltage.
- Guard ring construction for transient protection.

### Mechanical data

- Case: SOD-123, Molded Plastic
- Terminals: Solderable per MIL-STD-202, Method 208
- Approx. Weight: 0.04 gram

### Circuit diagram

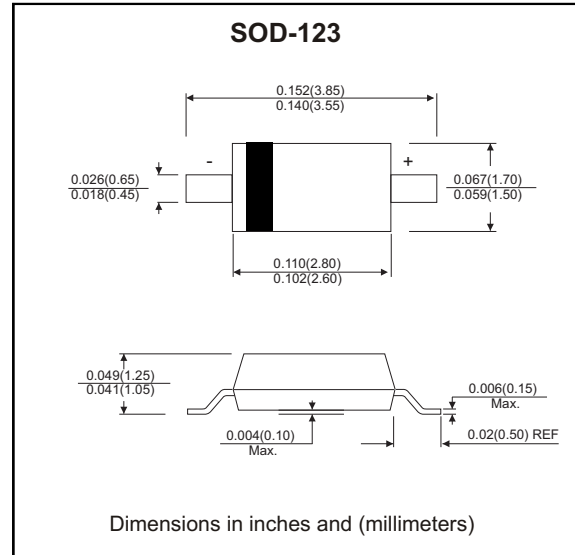

### Maximum Ratings (at Ta=25°C unless otherwise noted)

Parameter	Conditions	Symbol	Limits	Unit
Peak repetitive peak reverse voltage		VRRM	100	V
Working peak reverse voltage		VRWM		
DC blocking voltage		VR		
Forward continuous current		IF	150	mA
Repetitive Peak Forward current (Note 1)	@tp<1.0s, Duty Cycle<50%	IFRM	350	mA
Forward surge Forward current (Note 1)	@tp<10ms	IFSM	750	mA
Power dissipation		PD	200	mW
Thermal Resistance Junction to ambient air		RθJA	625	°C/W
Junction temperature		Tj	-55 to +150	°C
Storage temperature		TSTG	-55 to +150	°C

### Electrical Characteristics (at Ta=25°C unless otherwise noted)

Parameter	Conditions	Symbol	Min	Typ	Max	Unit
Reverse breakdown voltage (Note 2)	IR=100µA	VR	100			V
Forward voltage (Note 2)	IF1 = 0.1 mA IF2 = 10mA IF3 = 250mA	VF			0.25 0.45 1.0	V
Reverse Voltage Leakage current	VR1 = 1.5V VR2 = 10V VR3 = 50V VR4 = 75V	IR			0.3 0.5 1 2	µA
Diode capacitance	VR=0V, f = 1 MHz VR=1V, f = 1 MHz	CT		20 12		pF

Notes: 1.Part mounted on FR-4 board with recommended pad layout.  
2.Short duration pulse test used to minimize self-heating effect.

## RATING AND CHARACTERISTIC CURVES (CDBW46-G)

Fig.1 - Typical Forward Characteristics

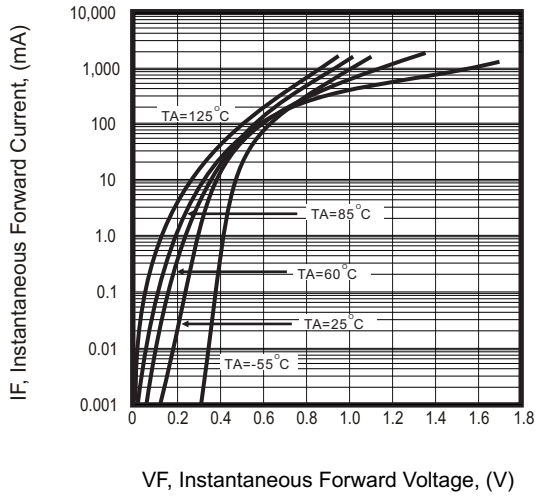

Fig.2 - Typical Reverse characteristics

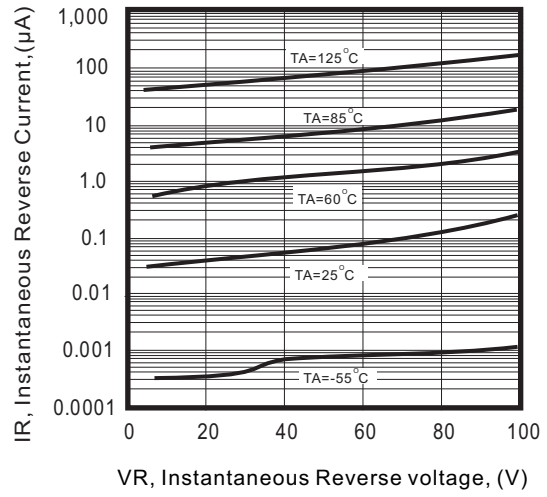

Fig.3 - Total Capacitance vs. Reverse Voltage

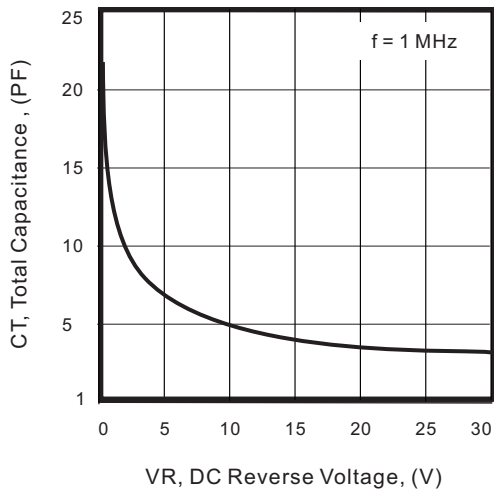
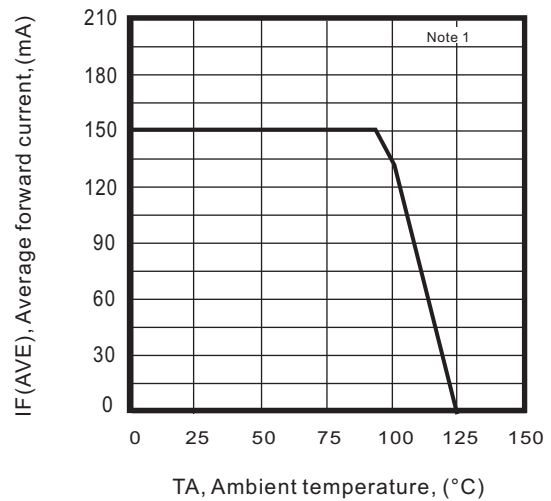
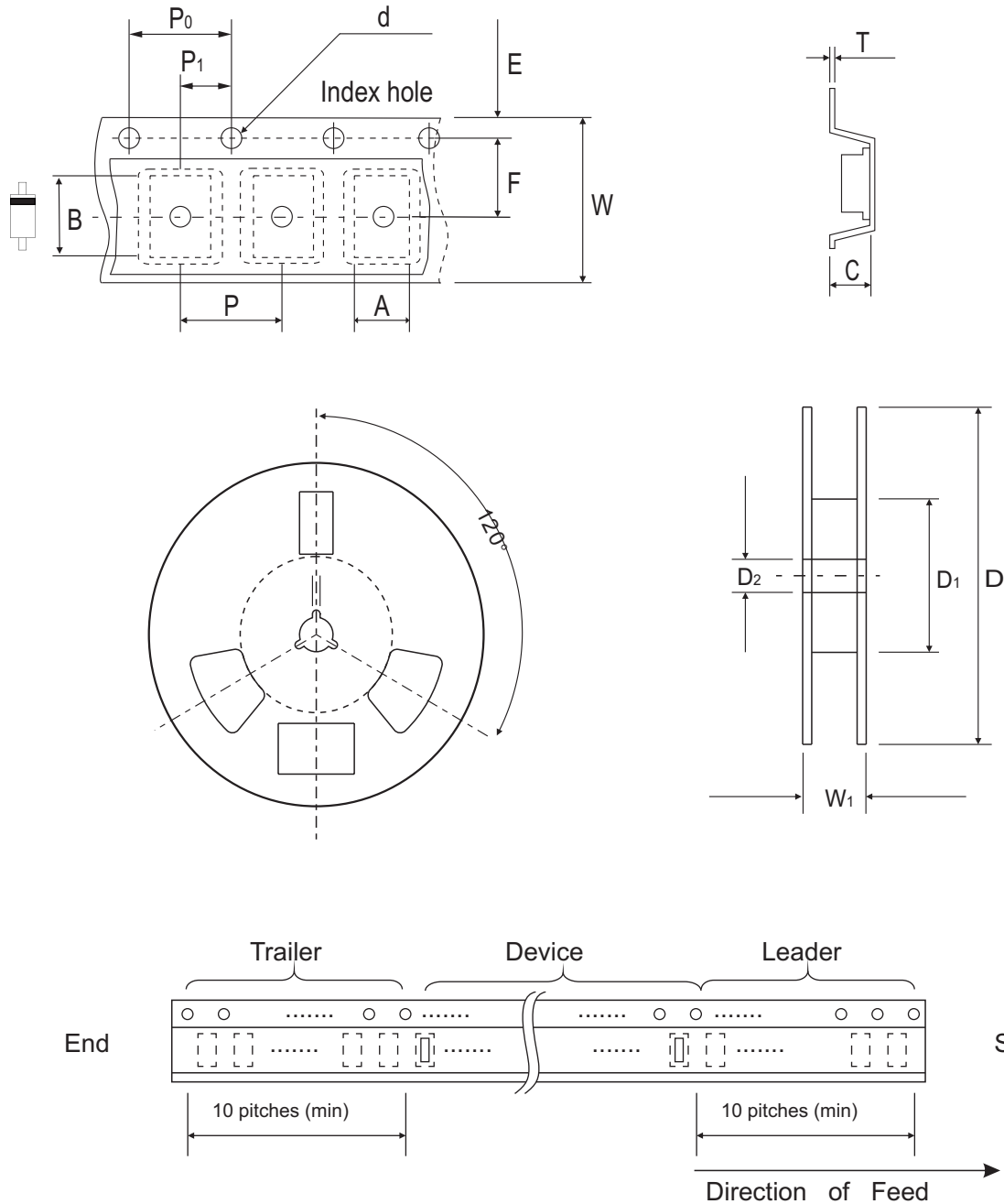

Fig.4 - Forward Current Derating



## Reel Taping Specification



SOD-123	SYMBOL	A	B	C	d	D	D1	D2
	(mm)	1.85 ± 0.10	3.94 ± 0.10	1.57 ± 0.10	1.55 ± 0.10	178 ± 1.00	54.40 ± 0.40	13.0 ± 0.20
	(inch)	0.073 ± 0.004	0.155 ± 0.004	0.062 ± 0.004	0.061 ± 0.004	7.008 ± 0.039	2.142 ± 0.016	0.512 ± 0.008

SOD-123	SYMBOL	E	F	P	P0	P1	W	W1
	(mm)	1.75 ± 0.10	3.50 ± 0.05	4.00 ± 0.10	4.00 ± 0.10	2.00 ± 0.10	8.00 + 0.30 / - 0.10	9.50 ± 1.00
	(inch)	0.069 ± 0.004	0.138 ± 0.002	0.158 ± 0.004	0.158 ± 0.004	0.079 ± 0.004	0.315 + 0.012 / - 0.004	0.374 ± 0.039

## Marking Code

Part Number	Marking Code
CDBW46-G	S9



xx= Product type marking code

## Suggested PAD Layout

SIZE	SOD-123	
	(mm)	(inch)
A	3.35	0.132
B	0.80	0.031
C	1.00	0.039
D	4.15	0.163
E	2.55	0.100

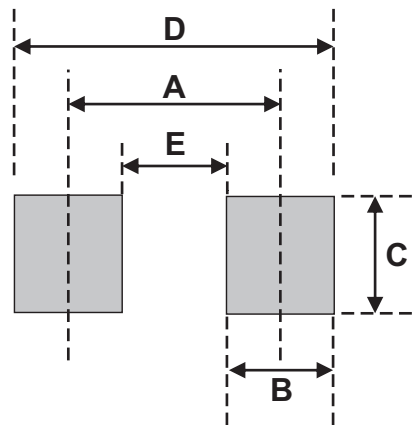

## Standard Packaging

Case Type	REEL PACK	
	REEL ( pcs )	Reel Size (inch)
SOD-123	3,000	7

## X-ON Electronics

Largest Supplier of Electrical and Electronic Components

*Click to view similar products for [Schottky Diodes & Rectifiers](#) category:*

*Click to view products by [Comchip](#) manufacturer:*

Other Similar products are found below :

[MA4E2039](#) [D1FH3-5063](#) [MBR10100CT-BP](#) [MBR1545CT](#) [MMBD301M3T5G](#) [RB160M-50TR](#) [RB551V-30](#) [BAS16E6433HTMA1](#) [BAT](#)  
[54-02LRH E6327](#) [NSR05F40QNXT5G](#) [NTE555](#) [JANS1N6640](#) [SB07-03C-TB-H](#) [SK310-T](#) [SK32A-LTP](#) [SK33A-TP](#) [SK34B-TP](#) [SS3003CH-](#)  
[TL-E](#) [GA01SHT18](#) [CRS10I30A\(TE85L,QM](#) [MA4E2501L-1290](#) [MBRA140TRPBF](#) [MBRB30H30CT-1G](#) [SB007-03C-TB-E](#) [SK32A-TP](#)  
[SK33B-TP](#) [SK35A-TP](#) [SK38B-TP](#) [NRVBM120LT1G](#) [NTE505](#) [NTSB30U100CT-1G](#) [SS15E-TP](#) [VS-6CWQ10FNHM3](#) [ACDBA1100LR-HF](#)  
[ACDBA1200-HF](#) [ACDBA140-HF](#) [ACDBA2100-HF](#) [ACDBA3100-HF](#) [CDBQC0530L-HF](#) [CDBQC0240LR-HF](#) [BAT6202VH6327XTSA1](#)  
[ACDBA340-HF](#) [ACDBA260LR-HF](#) [ACDBA1100-HF](#) [SK310B-TP](#) [MA4E2502L-1246](#) [MA4E2502H-1246](#) [NRVBM120ET1G](#)  
[NSR01L30MXT5G](#) [NTE573](#)