

CDST-7000-G

Reverse Voltage: 100 Volts
Forward Current: 200 mA
RoHS Device

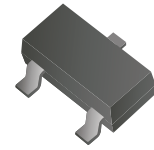

Features

- Design for mounting on small surface.
- High speed switching.
- High mounting capability, strong surge withstand, high reliability.

Mechanical data

- Case: SOT-23, molded plastic.
- Terminals: Solderable per MIL-STD-750, method 2026.
- Weight: 0.008 grams(approx.)

Circuit Diagram

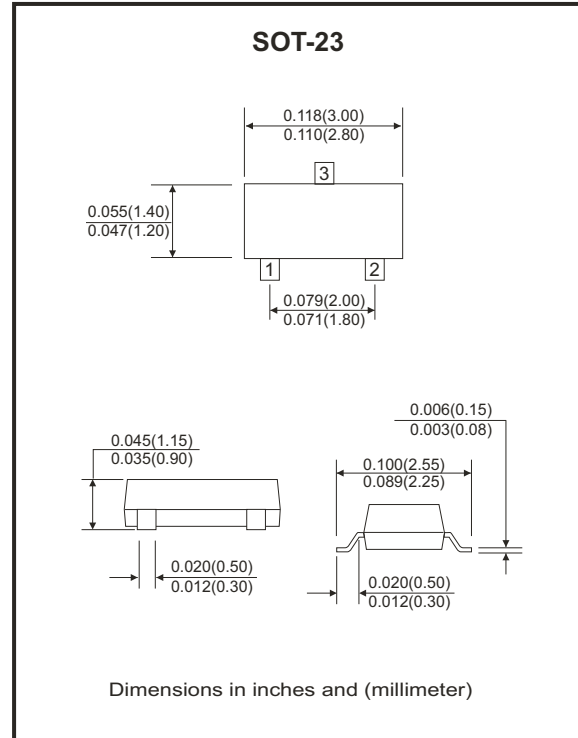
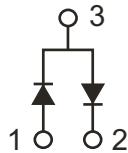

Maximum Rating (at Ta=25°C unless otherwise noted)

Parameter	Parameter	Symbol	Value	Unit
Non-Repetitive peak reverse voltage		V _{RM}	100	V
Peak repetitive reverse voltage		V _R RM	75	V
Working peak reverse voltage		V _R WM	75	V
RMS reverse voltage		V _R (RMS)	53	V
Average rectified output current		I _O	200	mA
Non-repetitive peak forward surge current	T = 1.0μs	I _{FSM}	2	A
Power dissipation		P _D	225	mW
Thermal resistance	Junction to ambient	R _{θJA}	556	°C/W
Junction temperature range		T _j	-40 to +150	°C
Storage temperature range		T _{STG}	-55 to +150	°C

Electrical Characteristics (at $T_a=25^\circ\text{C}$ unless otherwise noted)

Parameter	Symbol	Conditions	Min.	Max.	Unit
Reverse breakdown voltage	V_{BR}	$I_R = 100\mu\text{A}$	100		V
Reverse voltage leakage current	I_R	$V_R = 50\text{V}$ $V_R = 100\text{V}$		1 3	μA
Forward voltage	V_F	$I_F = 1\text{mA}$ $I_F = 10\text{mA}$ $I_F = 100\text{mA}$		0.70 0.82 1.1	V
Diode capacitance	C_j	$V_R = 0\text{V}, f = 1\text{MHz}$		2	pF
Reverse recovery time	T_{rr}	$I_F = I_R = 10\text{mA}, I_{rr} = 10\text{mA}$ $I_{rr} = 0.1 \times I_R, R_L = 100\Omega$		4	nS

RATING AND CHARACTERISTIC CURVES (CDST-7000-G)

Fig.1 - Forward Characteristics

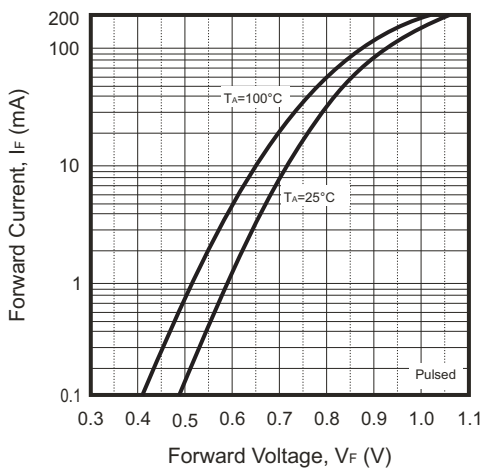

Fig.2 - Reverse Characteristics

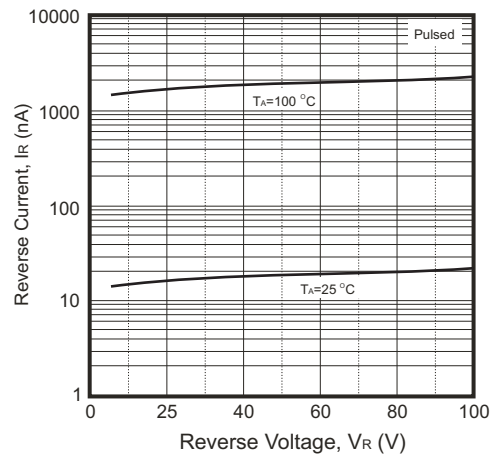

Fig.3 - Capacitance Characteristics

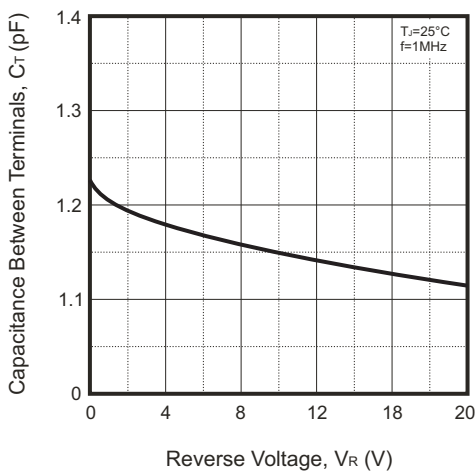
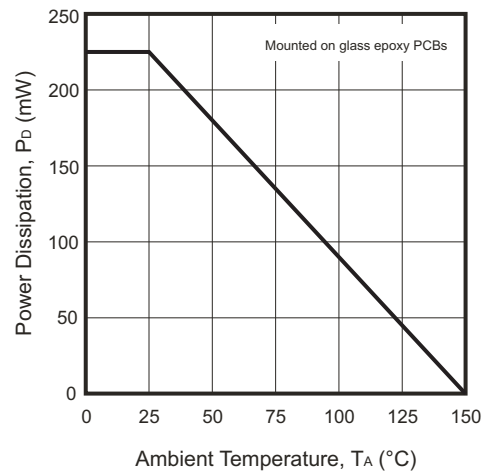
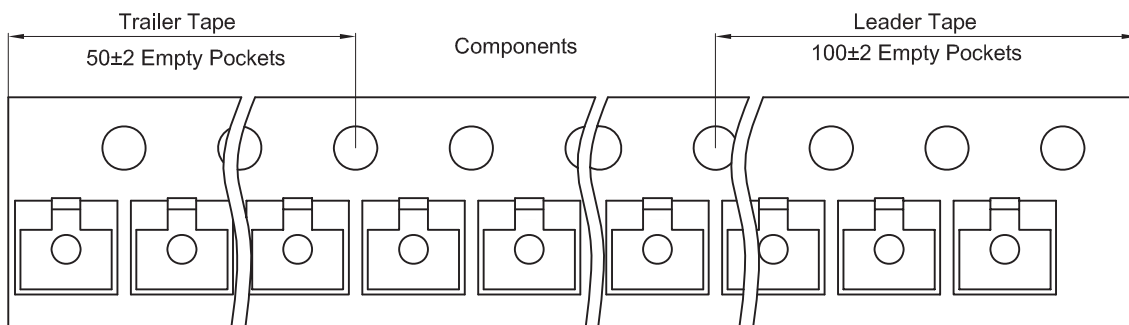
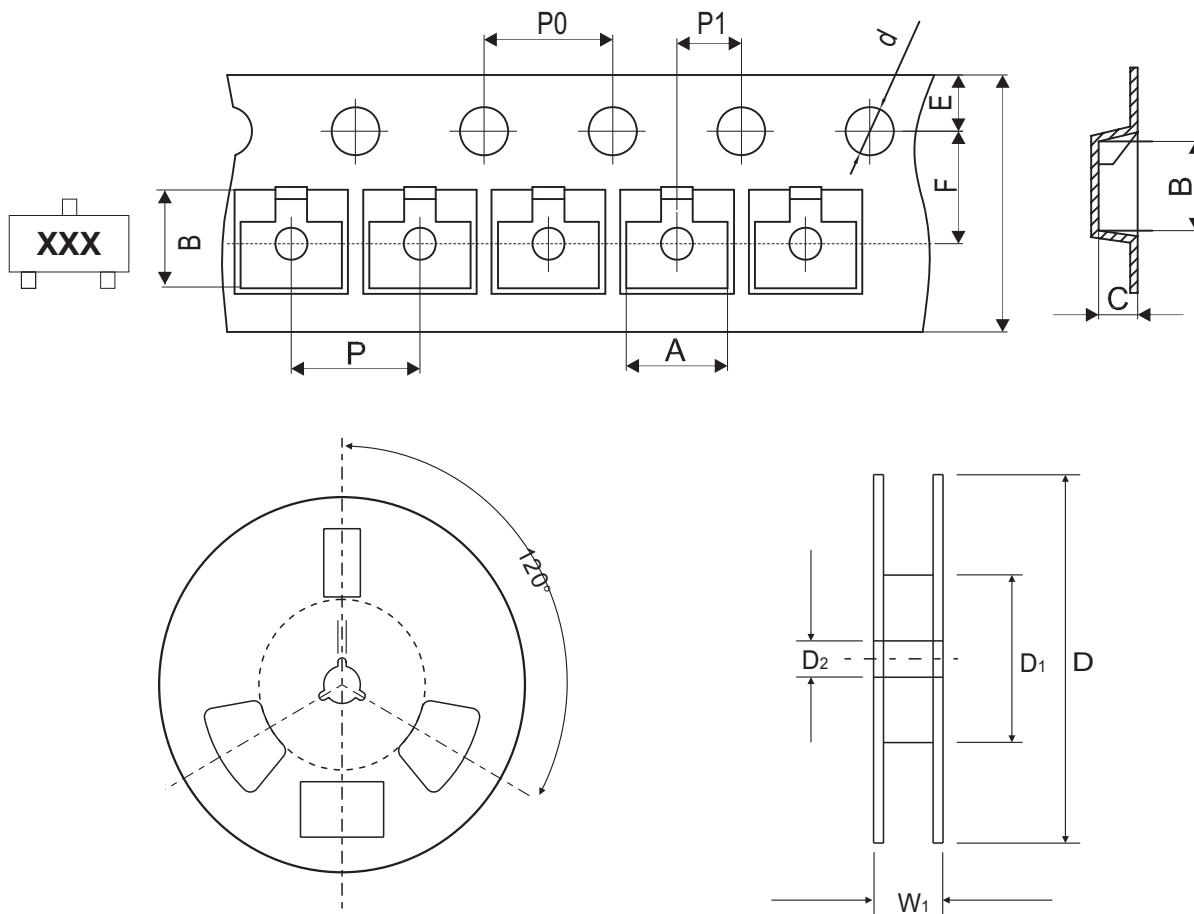

Fig.4 - Power Derating Curve



Reel Taping Specification



SOT-23	SYMBOL	A	B	C	d	D	D1	D2
	(mm)	3.15 ± 0.10	2.77 ± 0.10	1.22 ± 0.10	1.50 ± 0.10	178.00 ± 2.00	54.40 ± 1.00	13.00 ± 1.00
	(inch)	0.124 ± 0.004	0.109 ± 0.004	0.048 ± 0.004	0.059 ± 0.004	7.008 ± 0.079	2.142 ± 0.039	0.512 ± 0.039

SOT-23	SYMBOL	E	F	P	P0	P1	W	W1
	(mm)	1.75 ± 0.10	3.50 ± 0.10	4.00 ± 0.10	4.00 ± 0.10	2.00 ± 0.10	8.00 + 0.30 / - 0.10	12.30 ± 1.00
	(inch)	0.069 ± 0.004	0.138 ± 0.004	0.157 ± 0.004	0.157 ± 0.004	0.079 ± 0.004	0.315 + 0.012 / - 0.004	0.484 ± 0.039

Company reserves the right to improve product design, functions and reliability without notice.

REV:B

Marking Code

Part Number	Marking Code
CDST-7000-G	M5C

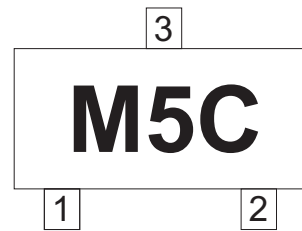

Suggested PAD Layout

SIZE	SOT-23	
	(mm)	(inch)
A	0.80	0.031
B	0.60	0.024
C	1.90	0.075
D	2.02	0.080
E	2.82	0.111

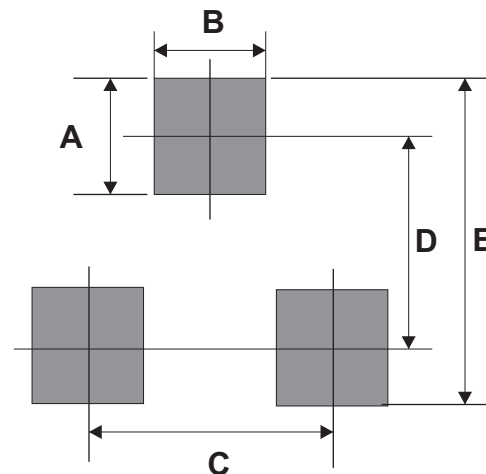

Standard Packaging

Case Type	Qty Per Reel	Reel Size
	(Pcs)	(inch)
SOT-23	3,000	7

X-ON Electronics

Largest Supplier of Electrical and Electronic Components

Click to view similar products for [Diodes - General Purpose, Power, Switching category](#):

Click to view products by [Comchip manufacturer](#):

Other Similar products are found below :

[RD0306T-H](#) [BAV17-TR](#) [BAV19-TR](#) [1N3611](#) [NTE156A](#) [NTE525](#) [NTE571](#) [NTE574](#) [NTE5804](#) [NTE5806](#) [NTE6244](#) [1SS181-TP](#)
[1SS193,LF](#) [1SS400CST2RA](#) [SDAA13](#) [SHN2D02FUTW1T1G](#) [LS4151GS08](#) [1N4449](#) [1N456A](#) [1N4934-E3/73](#) [1N914B](#) [1N914BTR](#)
[RFUH20TB3S](#) [BAS 28 E6327](#) [BAV199-TP](#) [BAW56DWQ-7-F](#) [BAW75-TAP](#) [MM230L-CAA](#) [IDW40E65D1](#) [JAN1N3600](#) [LL4151-GS18](#)
[053684A](#) [SMMSD4148T3G](#) [707803H](#) [NSVDAN222T1G](#) [SP000010217](#) [CDSZC01100-HF](#) [BAV199E6433HTMA1](#) [BAV70M3T5G](#)
[SMBT2001T1G](#) [NTE5801](#) [NTE5800](#) [NTE5808](#) [NTE6240](#) [NTE6248](#) [DLM10C-AT1](#) [BAS28-7](#) [BAW56HDW-13](#) [BAS28 TR](#) [VS-](#)
[HFA04SD60STR-M3](#)