

CFRB201-G Thru. CFRB207-G

Reverse Voltage: 50 to 1000 Volts

Forward Current: 2.0 Amp

RoHS Device

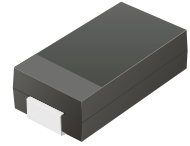

Features

- Ideal for surface mount applications.
- Easy pick and place.
- Plastic package has Underwriters Lab. flammability classification 94V-0.
- Fast recovery time: 150~500nS.
- Low leakage current.

Mechanical data

- Case: JEDEC DO-214AA, molded plastic.
- Terminals: solderable per MIL-STD-750, method 2026.
- Polarity: Color band denotes cathode end.
- Approx. weight: 0.093 grams

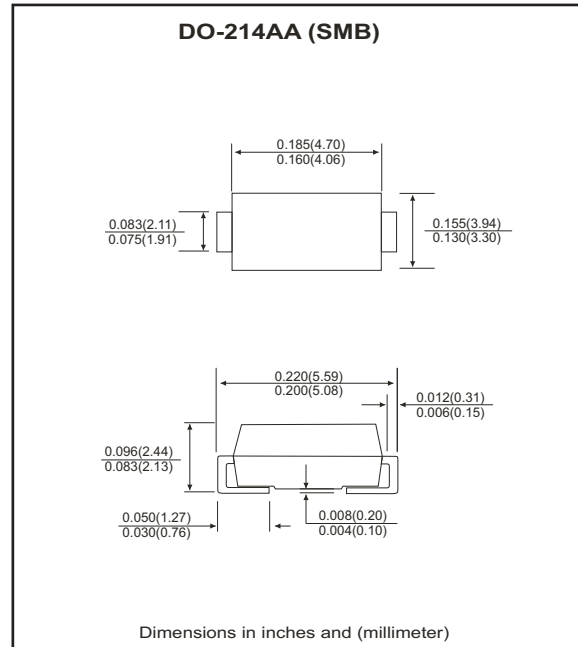

Maximum Ratings and Electrical Characteristics

Parameter	Symbol	CFRB 201-G	CFRB 202-G	CFRB 203-G	CFRB 204-G	CFRB 205-G	CFRB 206-G	CFRB 207-G	Units
Max. repetitive peak reverse voltage	V_{RRM}	50	100	200	400	600	800	1000	V
Max. DC blocking voltage	V_{DC}	50	100	200	400	600	800	1000	V
Max. RMS voltage	V_{RMS}	35	70	140	280	420	560	700	V
Peak surge forward current, 8.3ms single half sine-wave superimposed on rate load (JEDEC method)	I_{FSM}	50							A
Max. average forward current	I_o	2.0							A
Max. instantaneous forward voltage at 2.0A	V_F	1.3							V
Reverse recovery time	T_{rr}	150				250	500		nS
Max. DC reverse current at $T_A=25^{\circ}C$ rated DC blocking voltage $T_A=125^{\circ}C$	I_R	5.0					50		μA
Max. thermal resistance (Note 1)	$R_{\theta JL}$	20					$^{\circ}C/W$		
Max. operating junction temperature	T_J	150							$^{\circ}C$
Storage temperature	T_{STG}	-55 to +150							$^{\circ}C$

Notes: 1. Thermal resistance from junction to lead mounted on P.C.B. with 8.0x8.0 mm square² (0.13mm thick) land area.

RATING AND CHARACTERISTIC CURVES (CFRB201-G thru CFRB207-G)

Fig.1 Reverse Characteristics

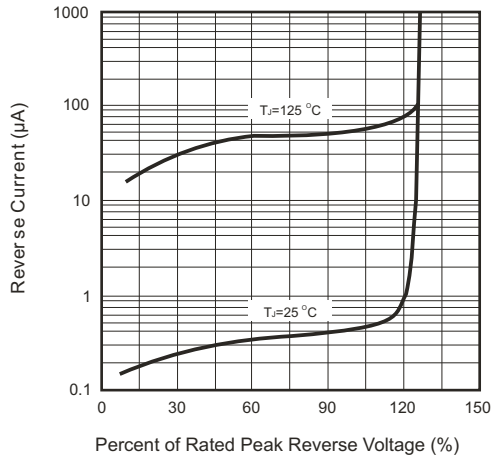

Fig.2 Forward Characteristics

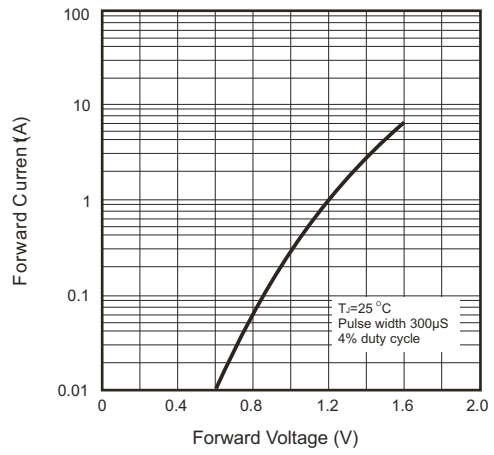

Fig.3 Junction Capacitance

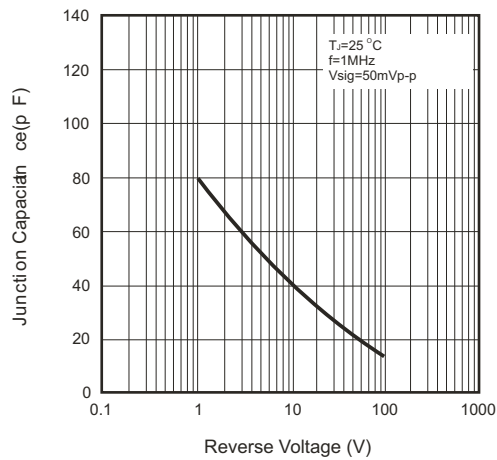

Fig.4 Non-repetitive Forward Surge Current

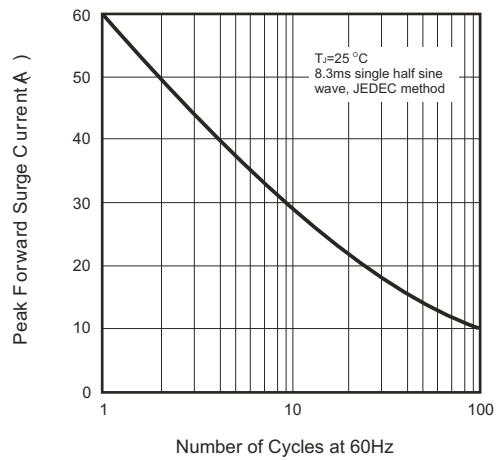

Fig.5 Test Circuit Diagram and Reverse Recovery Time Characteristics

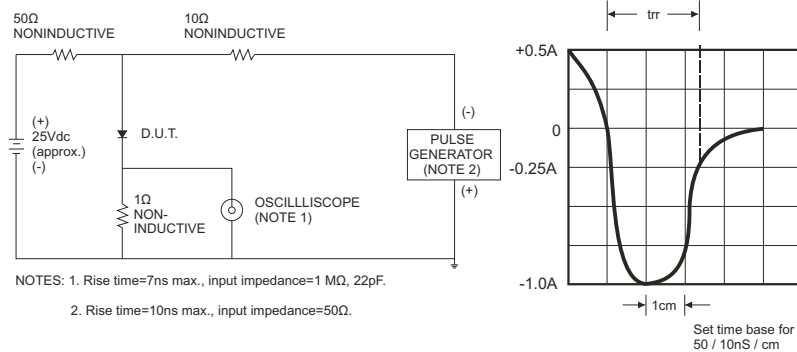
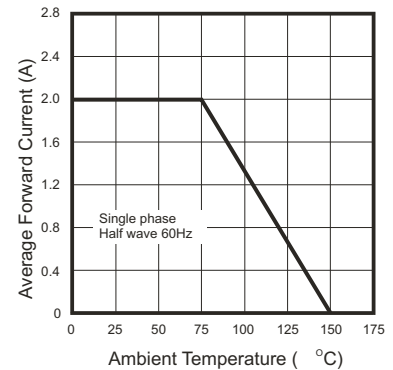

Fig.6 Current Derating Curve



X-ON Electronics

Largest Supplier of Electrical and Electronic Components

Click to view similar products for [Rectifiers](#) category:

Click to view products by [Comchip](#) manufacturer:

Other Similar products are found below :

[70HFR40](#) [RL252-TP](#) [150KR30A](#) [1N5397](#) [NTE5841](#) [NTE6038](#) [SCF5000](#) [1N4002G](#) [1N4005-TR](#) [JANS1N6640US](#) [481235F](#)
[RRE02VS6SGTR](#) [067907F](#) [MS306](#) [70HF40](#) [T110HF60](#) [T85HFL60S02](#) [US2JFL-TP](#) [A1N5404G-G](#) [CRS04\(T5L,TEMQ\)](#) [ACGRA4007-HF](#)
[ACGRB207-HF](#) [CLH03\(TE16L,Q\)](#) [ACGRC307-HF](#) [ACEFC304-HF](#) [NTE6356](#) [NTE6359](#) [NTE6002](#) [NTE6023](#) [NTE6039](#) [NTE6077](#)
[85HFR60](#) [40HFR60](#) [1N1186RA](#) [70HF120](#) [85HFR80](#) [D126A45C](#) [SCF7500](#) [D251N08B](#) [SCHJ22.5K](#) [SM100](#) [SCPA2](#) [SCH10000](#) [SDHD5K](#)
[VS-12FL100S10](#) [ACGRA4001-HF](#) [D1821SH45T PR](#) [D1251S45T](#) [NTE5990](#) [NTE6358](#)