

## CPDFR Series-HF

RoHS Device  
Halogen Free

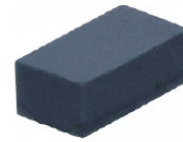

### Features

- Bi-directional ESD protection.
- Surface mount package.
- High component density.

### Mechanical data

- Case: 1005(2512) standard package, molded plastic.
- Terminals: Gold plated, solderable per MIL-STD-750,method 2026.
- Marking Code:  
 CPDFR5V0-HF: E05  
 CPDFR12V-HF: E12  
 CPDFR24V-HF: E24
- Mounting position: Any.
- Weight: 0.006 grams(approx.).

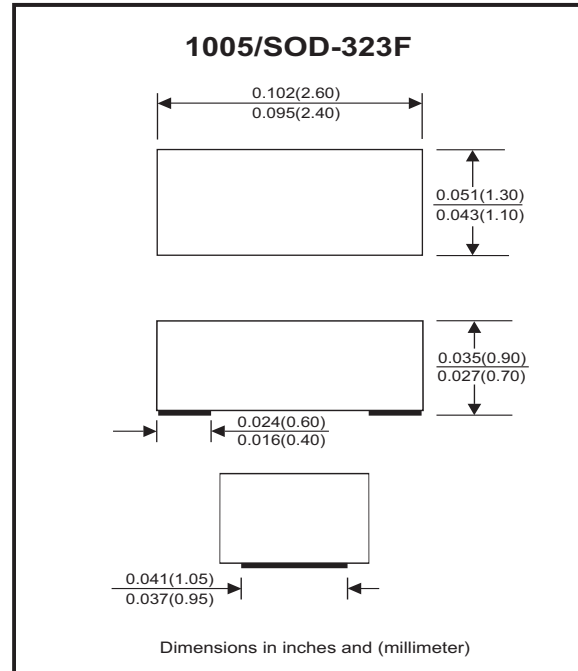

### Circuit diagram



### Electrical Characteristics (at T<sub>A</sub>=25°C unless otherwise noted)

| Parameter                   | Conditions  | Symbol           | Min             | Typ             | Max                  | Unit |
|-----------------------------|---|------------------|-----------------|-----------------|----------------------|------|
| Diode breakdown voltage     | CPDFR5V0-HF<br>CPDFR12V-HF<br>CPDFR24V-HF<br>I <sub>R</sub> = 1mA   | V <sub>BD</sub>  | 5.1<br>13<br>25 | 7.0<br>17<br>28 |                      | V    |
| Leakage current             | CPDFR5V0-HF<br>CPDFR12V-HF<br>CPDFR24V-HF<br>V <sub>R</sub> = 5V<br>V <sub>R</sub> = 12V<br>V <sub>R</sub> = 24V  | I <sub>L</sub>   |                 | 0.1             | 2.0                  | uA   |
| Junction capacitance        | CPDFR5V0-HF<br>CPDFR12V-HF<br>CPDFR24V-HF<br>V <sub>R</sub> = 0V, f = 1MHz  | C <sub>T</sub>   |                 | 15<br>12<br>10  | 20<br>-<br>-         | pF   |
| ESD capability              | CPDFR Series-HF<br>IEC 61000-4-2(air)<br>IEC 61000-4-2(contact)   | ESD              |                 |                 | 16<br>8              | kV   |
| Clamping voltage            | CPDFR5V0-HF<br>CPDFR12V-HF<br>CPDFR24V-HF<br>I <sub>PP</sub> = 1A, T <sub>P</sub> =8/20us<br>I <sub>PP</sub> = 5A, T <sub>P</sub> =8/20us<br>I <sub>PP</sub> = 1A, T <sub>P</sub> =8/20us<br>I <sub>PP</sub> = 1A, T <sub>P</sub> =8/20us | V <sub>C</sub>   |                 |                 | 10<br>15<br>25<br>47 | V    |
| Peak pulse power            | CPDFR5V0-HF<br>CPDFR12V-HF<br>CPDFR24V-HF<br>T <sub>P</sub> =8/20us   | P <sub>PP</sub>  |                 |                 | 75<br>25<br>47       | W    |
| Operation temperature range | CPDFR Series-HF   | T <sub>j</sub>   | -40             |                 | 125                  | °C   |
| Storage temperature range   | CPDFR Series-HF   | T <sub>STG</sub> | -55             |                 | 150                  | °C   |

## RATING AND CHARACTERISTIC CURVES (CPDFR Series-HF)

Fig.1 - Peak Pulse Current Wave  
Form Acc. IEC 61000-4-5

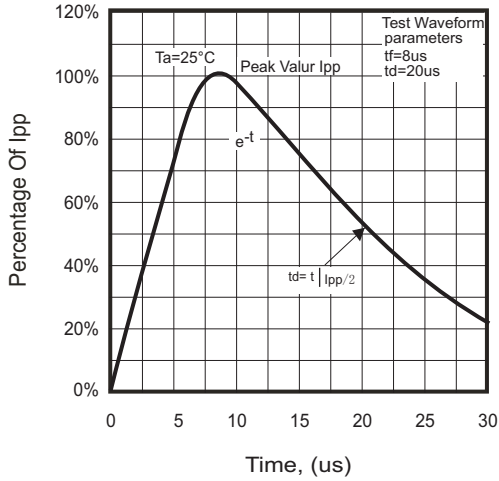

Fig.2-1 - Reverse Characteristics

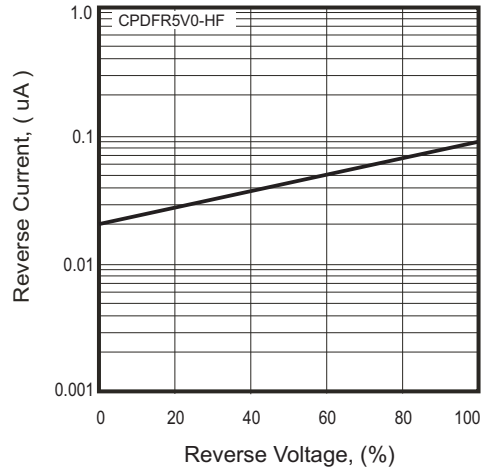

Fig.2-2 - Reverse Characteristics

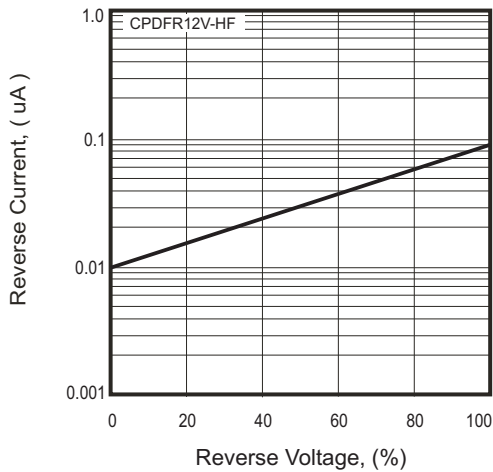

Fig.2-3 - Reverse Characteristics

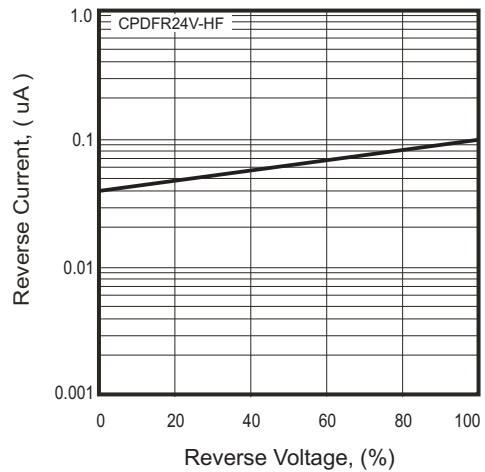

Fig.3 - Capacitance Between  
Terminals Characteristics

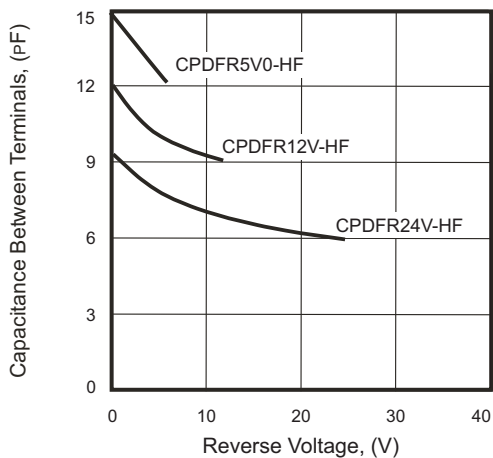
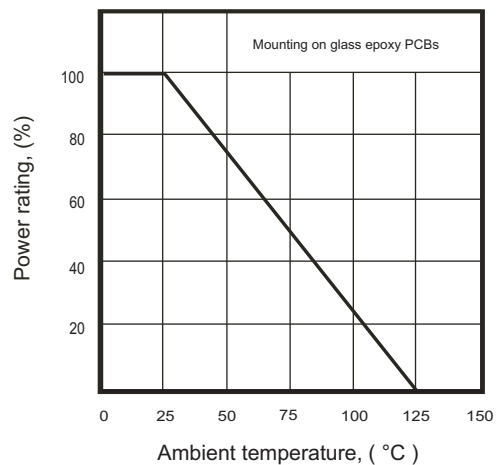
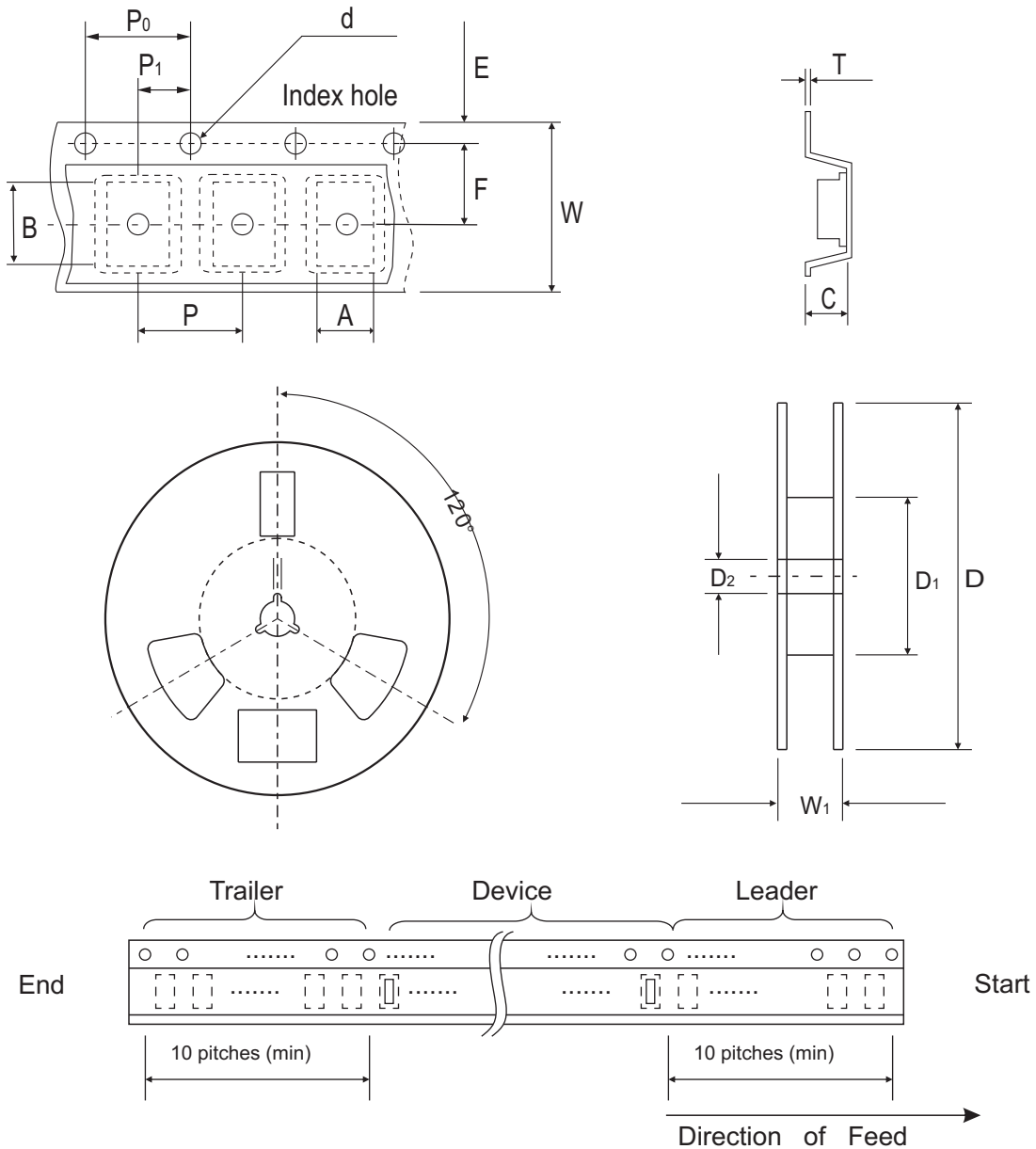

Fig. 4 - Power rating derating curve



## Reel Taping Specification



| 1005<br>(SOD-323F) | SYMBOL | A             | B             | C             | d             | D            | D <sub>1</sub> | D <sub>2</sub> |
|--------------------|--------|---------------|---------------|---------------|---------------|--------------|----------------|----------------|
|                    | (mm)   | 1.55 ± 0.10   | 2.65 ± 0.10   | 1.05 ± 0.10   | 1.55 ± 0.05   | 178 ± 1.0    | 60.0 MIN.      | 13.00 ± 0.20   |
|                    | (inch) | 0.061 ± 0.004 | 0.104 ± 0.004 | 0.041 ± 0.004 | 0.061 ± 0.002 | 7.008 ± 0.04 | 2.362 MIN.     | 0.512 ± 0.008  |

| 1005<br>(SOD-323F) | SYMBOL | E             | F             | P             | P <sub>0</sub> | P <sub>1</sub> | T             | W             | W <sub>1</sub> |
|--------------------|--------|---------------|---------------|---------------|----------------|----------------|---------------|---------------|----------------|
|                    | (mm)   | 1.75 ± 0.10   | 3.50 ± 0.05   | 4.00 ± 0.10   | 4.00 ± 0.10    | 2.00 ± 0.05    | 0.23 ± 0.05   | 8.00 ± 0.20   | 13.5 MAX.      |
|                    | (inch) | 0.069 ± 0.004 | 0.138 ± 0.002 | 0.157 ± 0.004 | 0.157 ± 0.004  | 0.079 ± 0.002  | 0.009 ± 0.002 | 0.315 ± 0.008 | 0.531 MAX.     |

## Marking Code

| Part Number | Marking Code |
|-------------|--------------|
| CPDFR5V0-HF | E05          |
| CPDFR12V-HF | E12          |
| CPDFR24V-HF | E24          |



xxx = Product type marking code

## Suggested PAD Layout

| SIZE | 1005/SOD-323F |        |
|------|---------------|--------|
|      | (mm)          | (inch) |
| A    | 2.00          | 0.079  |
| B    | 0.70          | 0.028  |
| C    | 1.30          | 0.051  |
| D    | 2.70          | 0.106  |
| E    | 1.30          | 0.051  |

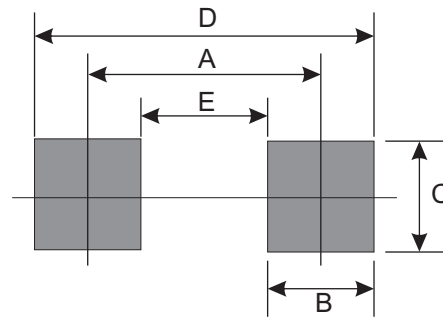

## Standard Packaging

| Case Type     | Qty Per Reel | Reel Size |
|---------------|--------------|-----------|
|               | (Pcs)        | (inch)    |
| 1005/SOD-323F | 4,000        | 7         |

## X-ON Electronics

Largest Supplier of Electrical and Electronic Components

*Click to view similar products for [ESD Suppressors / TVS Diodes](#) category:*

*Click to view products by [Comchip](#) manufacturer:*

Other Similar products are found below :

[60KS200C](#) [D12V0H1U2WS-7](#) [D18V0L1B2LP-7B](#) [82356050220](#) [D5V0M5U6V-7](#) [NTE4902](#) [P4KE27CA](#) [P6KE11CA](#) [P6KE39CA-TP](#)  
[P6KE8.2A](#) [SA110CA](#) [SA60CA](#) [SA64CA](#) [SMBJ12CATR](#) [SMBJ8.0A](#) [SMLJ30CA-TP](#) [ESD101-B1-02ELS E6327](#) [ESD112-B1-02EL E6327](#)  
[ESD119B1W01005E6327XTSA1](#) [ESD5V0L1B02VH6327XTSA1](#) [ESD7451N2T5G](#) [19180-510](#) [CPDT-5V0USP-HF](#) [3.0SMCJ33CA-F](#)  
[3.0SMCJ36A-F](#) [HSPC16701B02TP](#) [D3V3Q1B2DLP3-7](#) [D55V0M1B2WS-7](#) [DESD5V0U1BL-7B](#) [DRTR5V0U4SL-7](#) [SCM1293A-04SO](#)  
[ESD200-B1-CSP0201 E6327](#) [ESD203-B1-02EL E6327](#) [SM12-7](#) [SMF8.0A-TP](#) [SMLJ45CA-TP](#) [CEN955 W/DATA](#) [82350120560](#)  
[82356240030](#) [VESD12A1A-HD1-GS08](#) [CPDUR5V0R-HF](#) [CPDUR24V-HF](#) [CPDQC5V0U-HF](#) [CPDQC5V0USP-HF](#) [CPDQC5V0-HF](#)  
[D1213A-01LP4-7B](#) [D1213A-02WL-7](#) [ESDLIN1524BJ-HQ](#) [5KP100A](#) [5KP15A](#)