

## CPDQC12VA-HF

### RoHS Device

### Halogen Free



### Features

- Bi-directional ESD protection.
- IEC 61000-4-2 (ESD) ;  $\pm 30\text{KV}$ (contact)
- Surface mount package.
- High component density.
- Low clamping voltage.
- Low leakage.

### Mechanical data

- Case: 0402C/SOD-923F package, molded plastic.
- Terminals: Gold plated, solderable per MIL-STD-750, method 2026.
- Mounting position: Any.
- Weight: 0.001 grams (approx.).

### Circuit Diagram

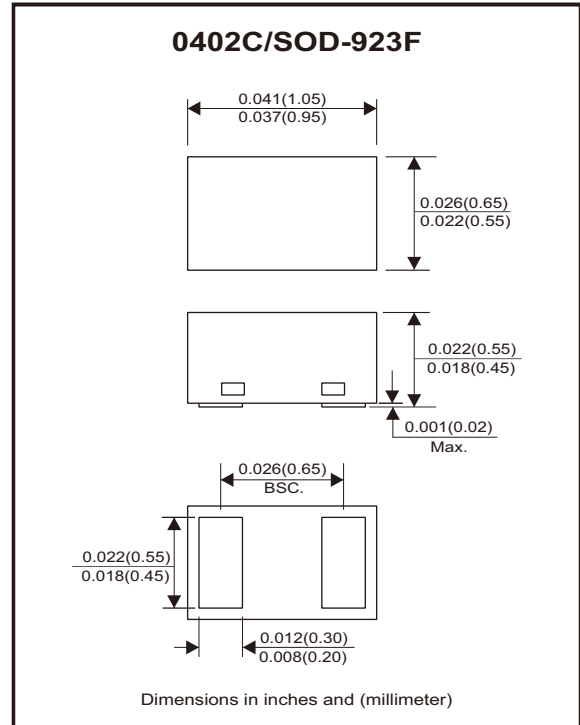

### Maximum Rating (at $T_A=25^\circ\text{C}$ unless otherwise noted)

Parameter	Conditions	Symbol	Value	Unit
Peak pulse power	$T_P = 8/20\mu\text{s}$	$P_{PP}$	170	W
Peak pulse current	$T_P = 8/20\mu\text{s}$	$I_{PP}$	5	A
ESD capability	IEC 61000-4-2(air)	ESD	$\pm 30$	kV
	IEC 61000-4-2(contact)	ESD	$\pm 30$	
Operating temperature range		$T_j$	$-40 \sim +125$	$^\circ\text{C}$
Storage temperature range		$T_{STG}$	$-55 \sim +150$	$^\circ\text{C}$

### Electrical Characteristics (at $T_A=25^\circ\text{C}$ unless otherwise noted)

Parameter	Conditions	Symbol	Min	Typ	Max	Unit
Working peak reverse voltage		$V_{RWM}$			12	V
Diode breakdown voltage	$I_T = 1\text{mA}$	$V_{BR}$	12.4			V
Reverse current	$V_{RWM} = 12\text{V}$	$I_R$			0.1	$\mu\text{A}$
Clamping voltage	$I_{PP} = 1\text{A}, T_P = 8/20\mu\text{s}$	$V_C$		16	22	V
	$I_{PP} = 5\text{A}, T_P = 8/20\mu\text{s}$	$V_C$		26	34	V
Junction capacitance	$V_R = 0\text{V}, f = 1\text{MHz}$	$C_J$		3	5	pF

## Rating and Characteristic Curves (CPDQC12VA-HF)

Fig.1- 8/20 $\mu$ s Peak Pulse Current Wave Form Acc. IEC61000-4-5

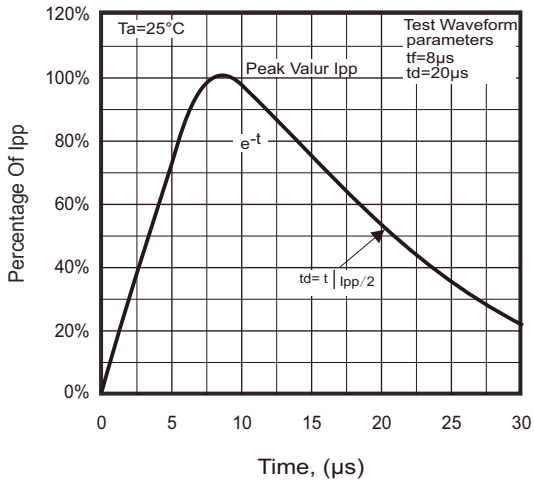

Fig.2 - Typical Capacitance Between Terminals Characteristics

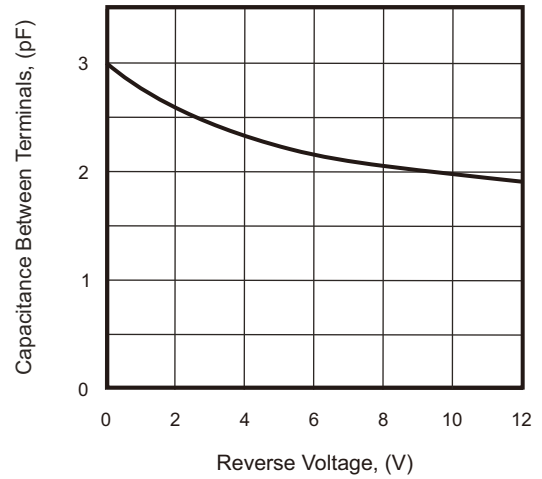

Fig.3 - Typical Clamping Voltage Vs. Peak Pulse Current

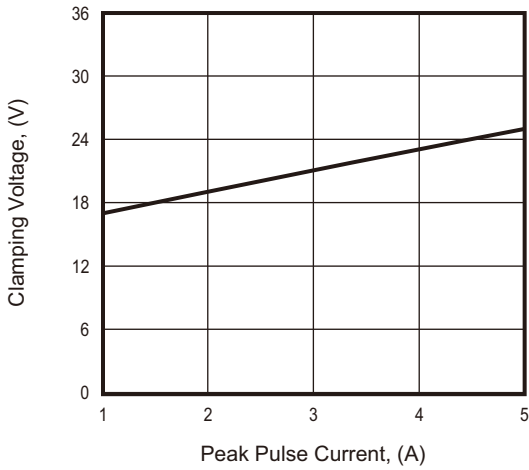
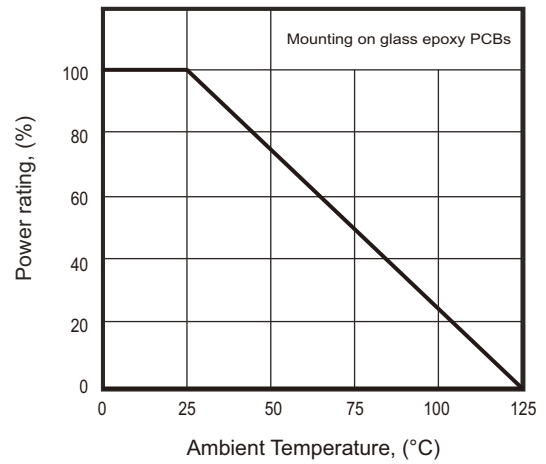
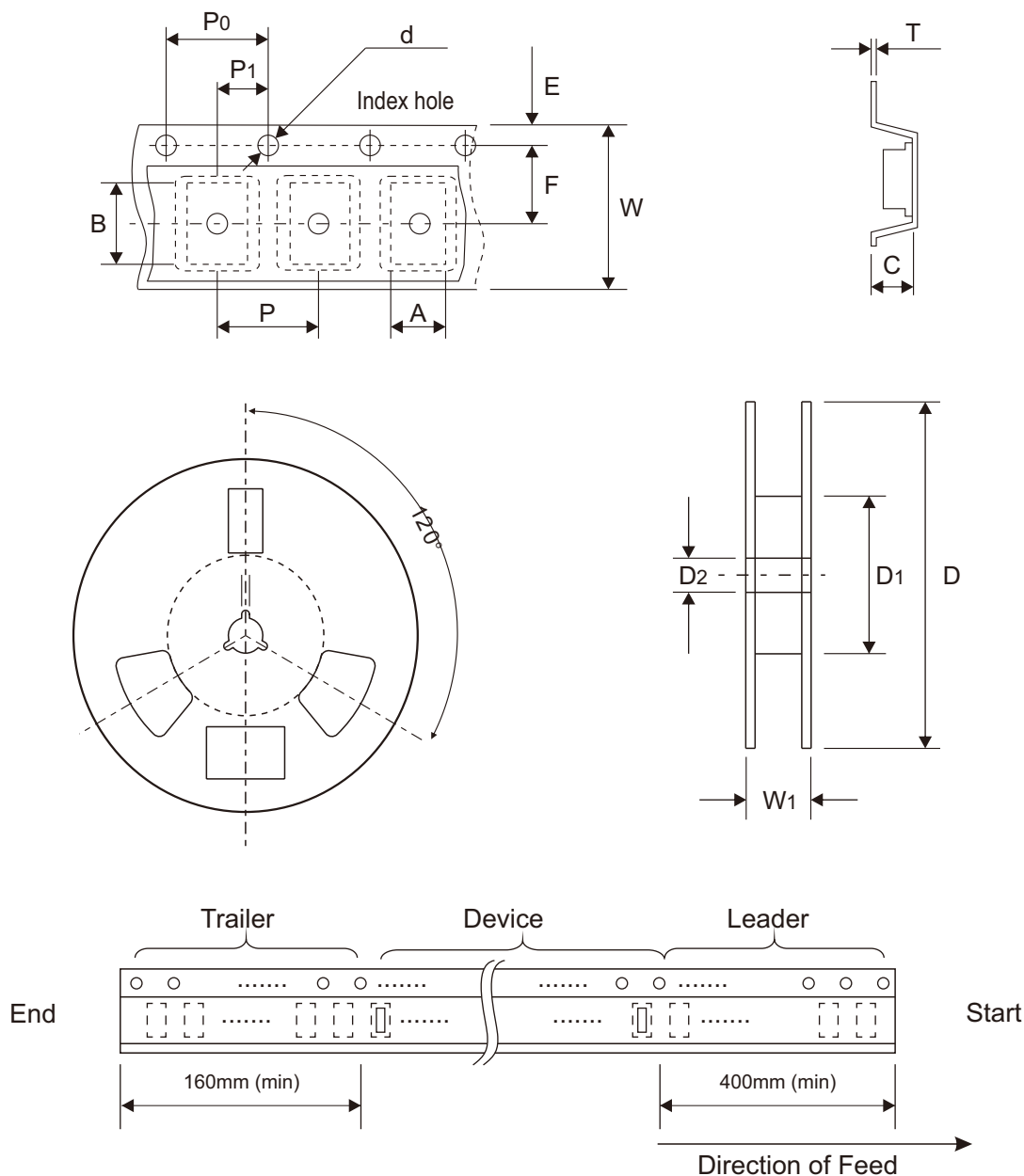

Fig. 4 - Power Rating Derating Curve



## Reel Taping Specification



0402C (SOD-923F)	SYMBOL	A	B	C	d	D	D1	D2
	(mm)	0.75 ± 0.05	1.17 ± 0.05	0.65 ± 0.05	1.50 + 0.10 - 0.00	178.00 ± 1.00	60.00 ± 0.50	13.50 ± 0.20
	(inch)	0.030 ± 0.002	0.046 ± 0.002	0.026 ± 0.002	0.059 + 0.004 - 0.000	7.008 ± 0.039	2.362 ± 0.020	0.531 ± 0.008

0402C (SOD-923F)	SYMBOL	E	F	P	P0	P1	T	W	W1
	(mm)	1.75 ± 0.10	3.50 ± 0.10	4.00 ± 0.10	4.00 ± 0.10	2.00 ± 0.10	0.20 + 0.02 - 0.05	8.00 ± 0.20	12.00 + 0.50 - 0.00
	(inch)	0.069 ± 0.004	0.138 ± 0.004	0.157 ± 0.004	0.157 ± 0.004	0.079 ± 0.004	0.008 + 0.001 - 0.002	0.315 ± 0.008	0.472 + 0.020 - 0.000

## Marking Code

Part Number	Marking Code
CPDQC12VA-HF	E2A



## Suggested PAD Layout

SIZE	0402C/SOD-923F	
	(mm)	(inch)
A	0.70	0.028
B	0.40	0.016
C	0.60	0.024
D	1.10	0.043
E	0.30	0.012

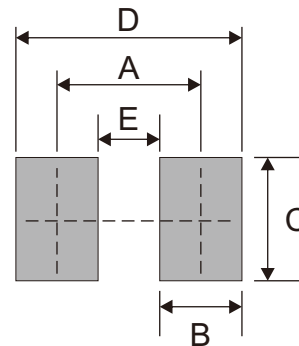

## Standard Packaging

Case Type	REEL PACK	
	REEL ( pcs )	Reel Size (inch)
0402C/SOD-923F	5,000	7

## X-ON Electronics

Largest Supplier of Electrical and Electronic Components

*Click to view similar products for [ESD Suppressors / TVS Diodes](#) category:*

*Click to view products by [Comchip](#) manufacturer:*

Other Similar products are found below :

[60KS200C](#) [D12V0H1U2WS-7](#) [D18V0L1B2LP-7B](#) [82356050220](#) [D5V0M5U6V-7](#) [NTE4902](#) [P4KE27CA](#) [P6KE11CA](#) [P6KE39CA-TP](#)  
[P6KE8.2A](#) [SA110CA](#) [SA60CA](#) [SA64CA](#) [SMBJ12CATR](#) [SMBJ8.0A](#) [SMLJ30CA-TP](#) [ESD101-B1-02ELS E6327](#) [ESD112-B1-02EL E6327](#)  
[ESD119B1W01005E6327XTSA1](#) [ESD5V0L1B02VH6327XTSA1](#) [ESD7451N2T5G](#) [19180-510](#) [CPDT-5V0USP-HF](#) [3.0SMCJ33CA-F](#)  
[3.0SMCJ36A-F](#) [HSPC16701B02TP](#) [D3V3Q1B2DLP3-7](#) [D55V0M1B2WS-7](#) [DESD5V0U1BL-7B](#) [DRTR5V0U4SL-7](#) [SCM1293A-04SO](#)  
[ESD200-B1-CSP0201 E6327](#) [ESD203-B1-02EL E6327](#) [SM12-7](#) [SMF8.0A-TP](#) [SMLJ45CA-TP](#) [CEN955 W/DATA](#) [82350120560](#)  
[82356240030](#) [VESD12A1A-HD1-GS08](#) [CPDUR5V0R-HF](#) [CPDUR24V-HF](#) [CPDQC5V0U-HF](#) [CPDQC5V0USP-HF](#) [CPDQC5V0-HF](#)  
[D1213A-01LP4-7B](#) [D1213A-02WL-7](#) [ESDLIN1524BJ-HQ](#) [5KP100A](#) [5KP15A](#)