

CPDV5-3V3UP-HF

RoHS Device
Halogen Free

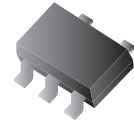

Features

- IEC61000-4-2 Level 4 ESD protection
- Working voltage: 3.3V
- Low leakage current.
- Low operating and clamping voltages.

Mechanical data

- Case: SOT-353 standard package ,molded plastic.
- Terminals: Tin plated, solderable per MIL-STD-750,method 2026.
- Mounting position: Any
- Weight: 0.0070 gram (approx.).

Circuit Diagram

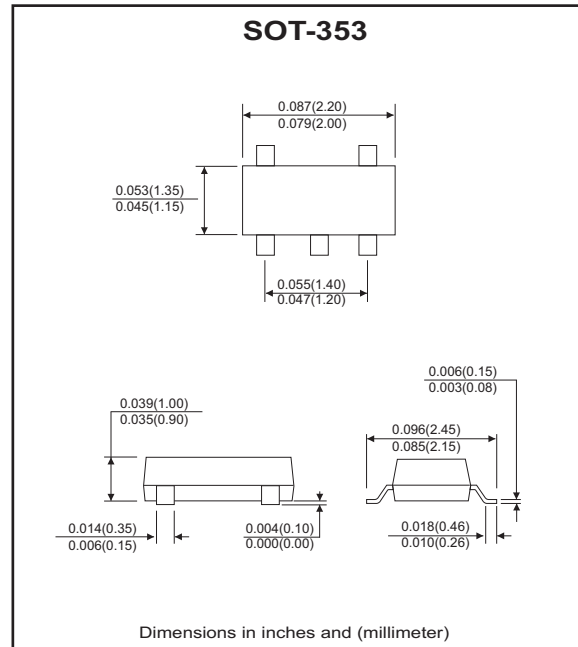
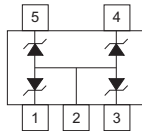

Maximum Ratings (at TA=25°C unless otherwise noted)

Parameter	Symbol	Value	Unit
Peak pulse power (tp = 8/20 us)	PPP	40	W
Peak pulse current (tp = 8/20 us)	IPP	5	A
ESD per IEC 61000-4-2(Air) ESD per IEC 61000-4-2(Contact)	VESD	±20 ±15	kV
Operating temperature	Tj	-55 to +125	°C
Storage temperature	TSTG	-55 to +125	°C

Electrical Characteristics (at TA=25°C unless otherwise noted)

Parameter	Conditions	Symbol	Min	Typ	Max	Unit
Reverse stand-off voltage		VRWM			3.3	V
Punch-through voltage	IP T = 2uA	VPT	3.5			V
Snap-back voltage	ISB = 50mA	VSB	2.8			V
Reverse leakage current	VRWM = 3.3V	IR		0.05	0.5	uA
Clamping voltage	IPP = 1 A, tp=8/20us	Vc			5.5	V
	IPP = 5 A, tp=8/20us	Vc			8.0	V
Reverse clamping voltage	IPPR = 1 A, tp=8/20us	VCR			2.4	V
Junction capacitance	VR = 0 V, f = 1MHz	Cj		12	16	pF

RATING AND CHARACTERISTIC CURVES (CPDV5-3V3UP-HF)

Fig.1 - Non-repetitive max. peak pulse power vs. pulse time

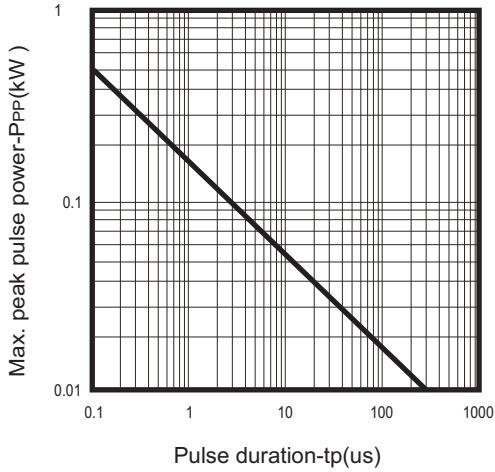

Fig.2 - Power rating derating curve

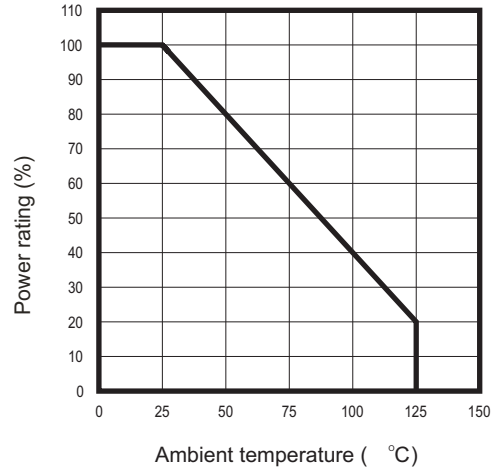

Fig.3 - Clamping voltage vs. peak pulse current

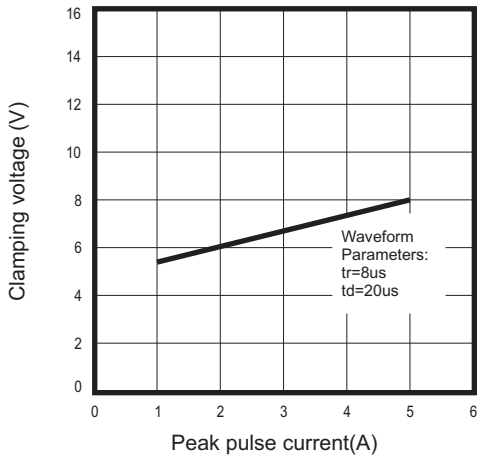

Fig.4 - Forward voltage vs. Forward current

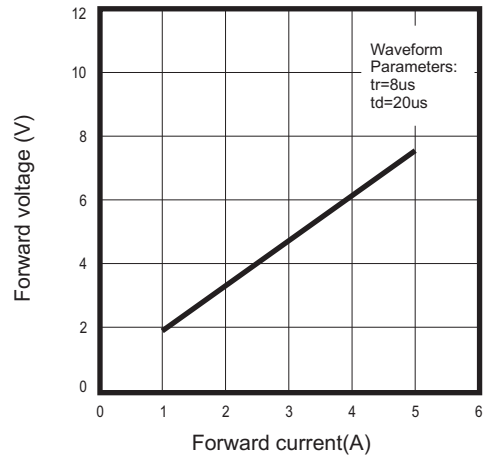
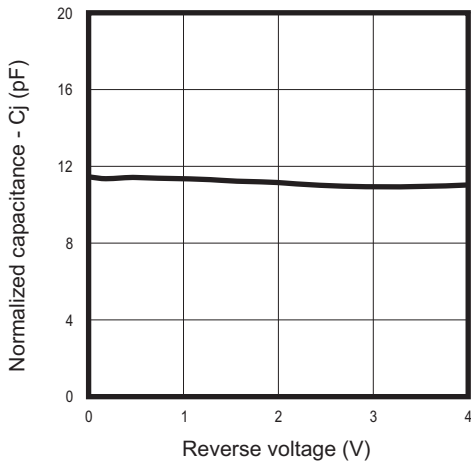
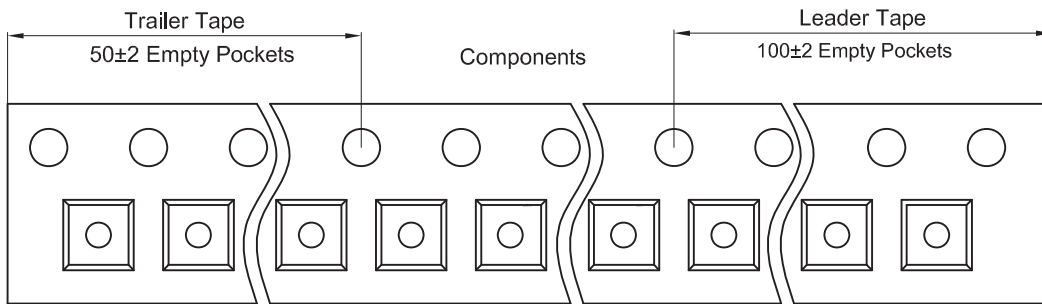
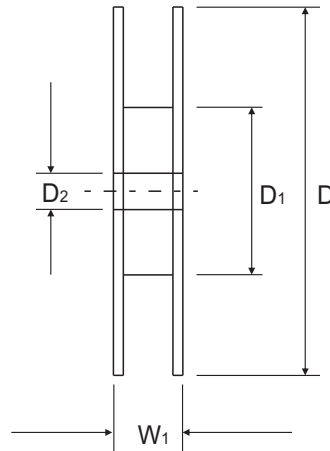
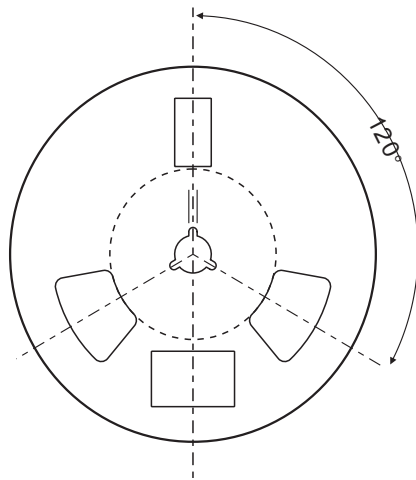
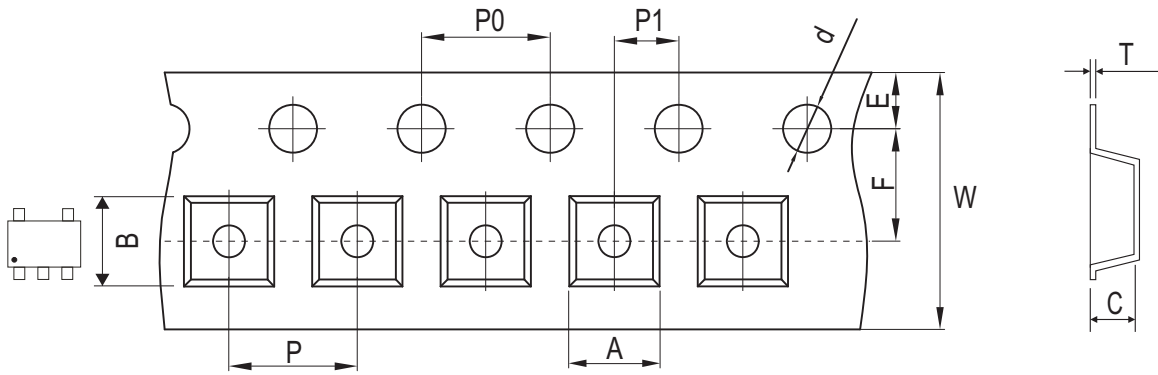

Fig.5 - Junction capacitance vs. reverse voltage



Reel Taping Specification



SOT-353	SYMBOL	A	B	C	d	D	D1	D2
	(mm)	2.25 ± 0.05	2.55 ± 0.05	1.20 ± 0.05	1.50 ± 0.10	178 ± 2.00	54.40 ± 1.00	13.00 ± 1.00
	(inch)	0.089 ± 0.002	0.100 ± 0.002	0.047 ± 0.002	0.059 ± 0.004	7.008 ± 0.079	2.142 ± 0.039	0.512 ± 0.039

SOT-353	SYMBOL	E	F	P	P0	P1	W	W1
	(mm)	1.75 ± 0.10	3.50 ± 0.10	4.00 ± 0.10	4.00 ± 0.10	2.00 ± 0.10	8.00 + 0.30 / - 0.10	12.30 ± 1.0
	(inch)	0.069 ± 0.004	0.138 ± 0.004	0.157 ± 0.004	0.157 ± 0.004	0.079 ± 0.004	0.315 + 0.012 / - 0.004	0.484 ± 0.039

Marking Code

Part Number	Marking Code
CPDV5-3V3UP-HF	E3V3

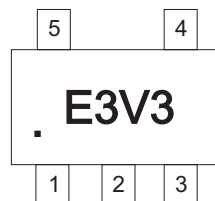

Suggested PAD Layout

SIZE	SOT-353	
	(mm)	(inch)
A	0.80	0.031
B	0.40	0.016
C	1.30	0.051
D	1.94	0.076
E	2.74	0.108

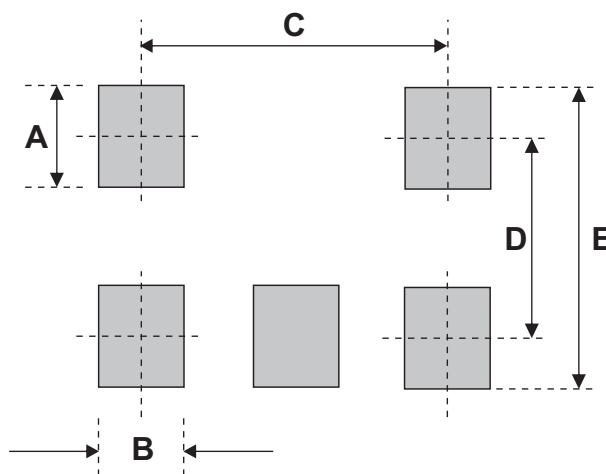

Standard Packaging

Case Type	REEL PACK	
	REEL (pcs)	Reel Size (inch)
SOT-353	3,000	7

X-ON Electronics

Largest Supplier of Electrical and Electronic Components

Click to view similar products for [ESD Suppressors / TVS Diodes](#) category:

Click to view products by [Comchip](#) manufacturer:

Other Similar products are found below :

[60KS200C](#) [D12V0H1U2WS-7](#) [D18V0L1B2LP-7B](#) [82356050220](#) [D5V0M5U6V-7](#) [NTE4902](#) [P4KE27CA](#) [P6KE11CA](#) [P6KE39CA-TP](#)
[P6KE8.2A](#) [SA110CA](#) [SA60CA](#) [SA64CA](#) [SMBJ12CATR](#) [SMBJ8.0A](#) [SMLJ30CA-TP](#) [ESD101-B1-02ELS E6327](#) [ESD112-B1-02EL E6327](#)
[ESD119B1W01005E6327XTSA1](#) [ESD5V0L1B02VH6327XTSA1](#) [ESD7451N2T5G](#) [19180-510](#) [CPDT-5V0USP-HF](#) [3.0SMCJ33CA-F](#)
[3.0SMCJ36A-F](#) [HSPC16701B02TP](#) [D3V3Q1B2DLP3-7](#) [D55V0M1B2WS-7](#) [DESD5V0U1BL-7B](#) [DRTR5V0U4SL-7](#) [SCM1293A-04SO](#)
[ESD200-B1-CSP0201 E6327](#) [ESD203-B1-02EL E6327](#) [SM12-7](#) [SMF8.0A-TP](#) [SMLJ45CA-TP](#) [CEN955 W/DATA](#) [82350120560](#)
[82356240030](#) [VESD12A1A-HD1-GS08](#) [CPDUR5V0R-HF](#) [CPDUR24V-HF](#) [CPDQC5V0U-HF](#) [CPDQC5V0USP-HF](#) [CPDQC5V0-HF](#)
[D1213A-01LP4-7B](#) [D1213A-02WL-7](#) [ESDLIN1524BJ-HQ](#) [5KP100A](#) [5KP15A](#)