

CURA101-HF Thru. CURA107-HF

Reverse Voltage: 50 to 1000 Volts

Forward Current: 1.0 Amp

RoHS Device

Halogen Free

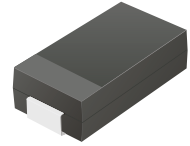

Features

- Ideal for surface mount applications.
- Easy pick and place.
- Plastic package has Underwriters Lab. flammability classification 94V-0.
- Ultra fast recovery time: 50~100nS.
- Low leakage current.

Mechanical data

- Case: JEDEC DO-214AC, molded plastic.
- Terminals: solderable per MIL-STD-750, method 2026.
- Polarity: Color band denotes cathode end.
- Approx. weight: 0.064 grams

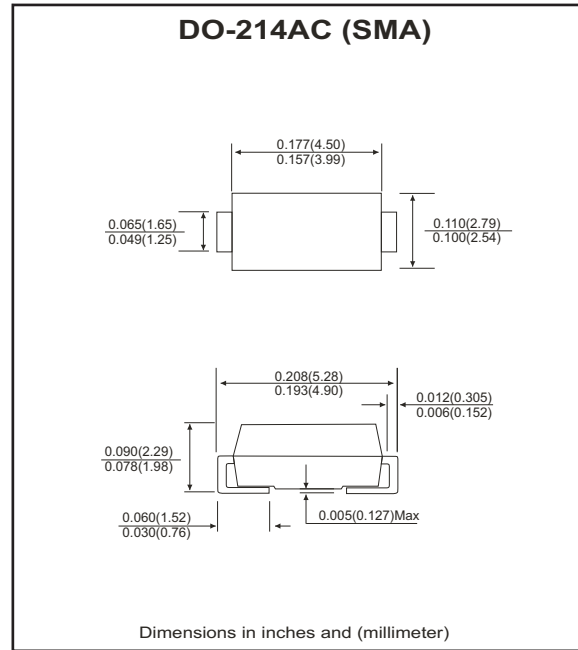

Maximum Ratings and Electrical Characteristics

Parameter	Symbol	CURA 101-HF	CURA 102-HF	CURA 103-HF	CURA 104-HF	CURA 105-HF	CURA 106-HF	CURA 107-HF	Units
Max. repetitive peak reverse voltage	V_{RRM}	50	100	200	400	600	800	1000	V
Max. DC blocking voltage	V_{DC}	50	100	200	400	600	800	1000	V
Max. RMS voltage	V_{RMS}	35	70	140	280	420	560	700	V
Peak surge forward current, 8.3ms single half sine-wave superimposed on rate load (JEDEC method)	I_{FSM}	30							A
Max. average forward rectified current At $T_A = 55^{\circ}C$	$I_{(AC)}$	1.0							A
Max. instantaneous forward voltage per at 1.0A	V_F	1.0		1.3		1.7		V	
Reverse recovery time	T_{rr}	50				100			nS
Typical Junction Capacitance (Measured at 1.0MHz and applied reves voltage of 4.0V)	C_J	20				15			nS
Max. DC reverse current at $T_A = 25^{\circ}C$ rated DC blocking voltage $T_A = 100^{\circ}C$	I_R	5.0				100			μA
Typical Thermal Resistance(Note 1)	$R_{\theta JL}$	88				$^{\circ}C/W$			
	$R_{\theta JL}$	28				$^{\circ}C/W$			
Operating junction temperature	T_J	-55 to +150							$^{\circ}C$
Storage temperature	T_{STG}	-55 to +150							$^{\circ}C$

Notes: 1. Thermal resistance from junction to lead.

RATING AND CHARACTERISTIC CURVES (CURA101-HF thru CURA107-HF)

Fig.1- Typical Forward Current Derating Curve

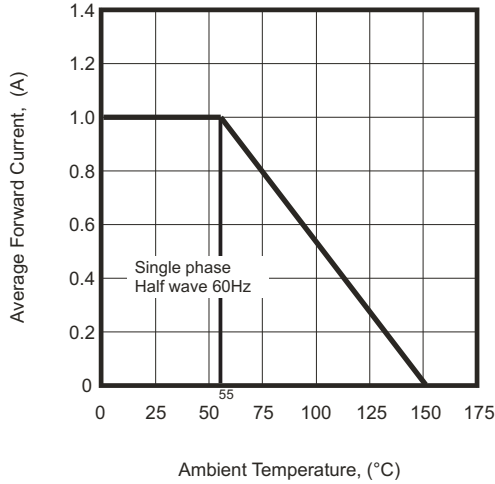

Fig.2 - Maximum NON-Repetitive Peak Forward Surge Current

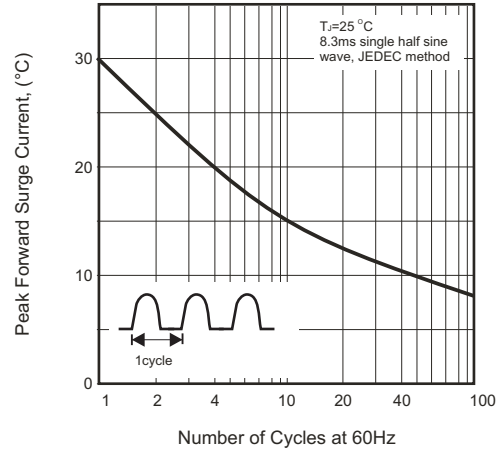

Fig.3 - Typical Instantaneous Forward Characteristics

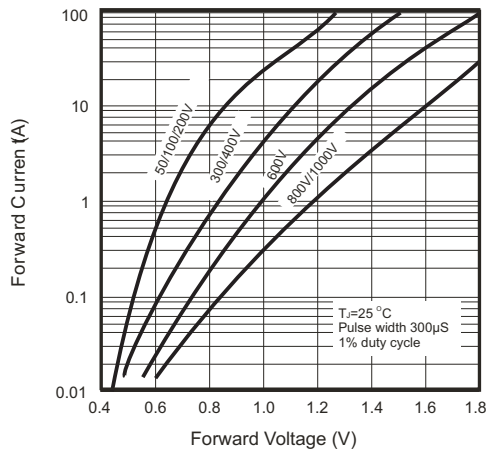

Fig.4 - Typical Reverse Characteristics

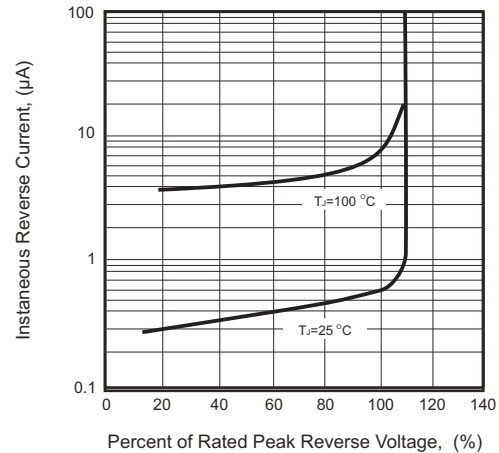

Fig.5 - Junction Capacitance

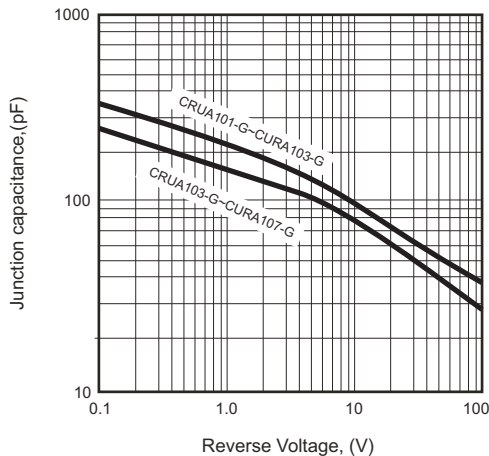
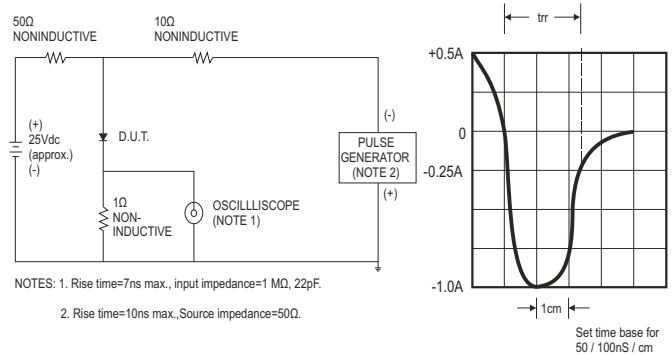
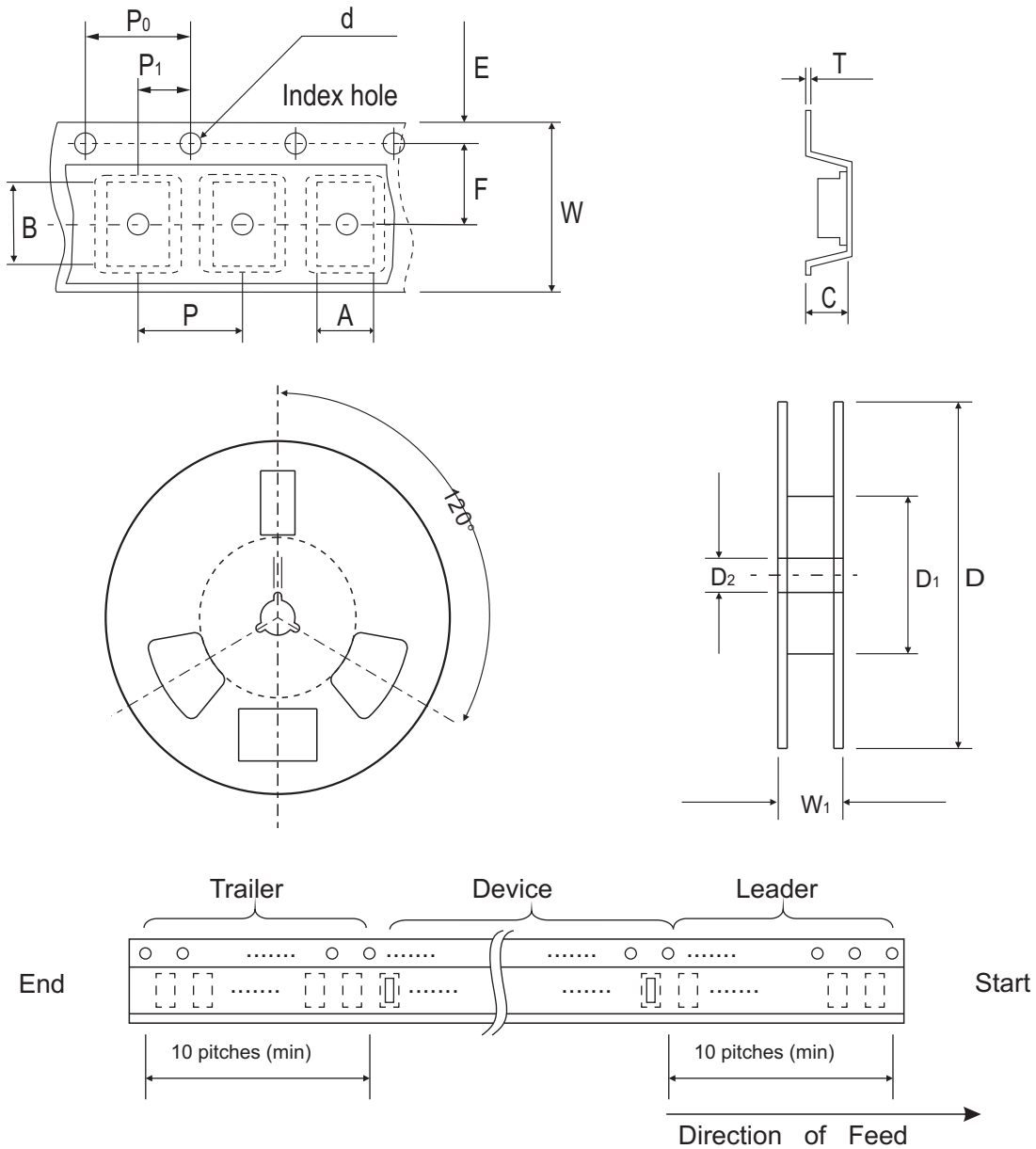

Fig.6 - Test Circuit Diagram and Reverse Recovery Time Characteristic



Reel Taping Specification



DO-214AC (SMA)	SYMBOL	A	B	C	d	D	D1	D2
	(mm)	2.7 Max	5.3 Max	2.66 Max	1.50 ± 0.10 DIA	330 ± 2.00	50.0 Min.	13.5 ± 1.00
	(inch)	0.106 Max	0.209 Max	0.105 Max	0.059 ± 0.004 DIA	13.00 ± 0.079	1.969 Min.	0.531 ± 0.039

DO-214AC (SMA)	SYMBOL	E	F	P	P0	P1	W	W1
	(mm)	1.75 ± 0.10	5.50 ± 0.05	4.00 ± 0.10	4.00 ± 0.10	2.00 ± 0.05	12.0 ± 0.30	18.4 Max.
	(inch)	0.689 ± 0.004	0.216 ± 0.002	0.157 ± 0.004	0.157 ± 0.004	0.079 ± 0.002	0.472 ± 0.012	0.724 Max

Marking Code

Part Number	Marking Code
CURA101-HF	U101
CURA102-HF	U102
CURA103-HF	U103
CURA104-HF	U104
CURA105-HF	U105
CURA106-HF	U106
CURA107-HF	U107

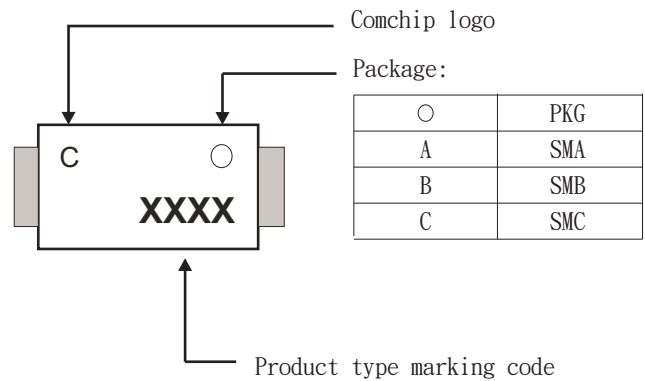

Suggested PAD Layout

SIZE	DO-214AC (SMA)	
	(mm)	(inch)
A	4.50	0.177
B	1.50	0.059
C	3.60	0.142
D	6.00	0.236
E	3.00	0.118

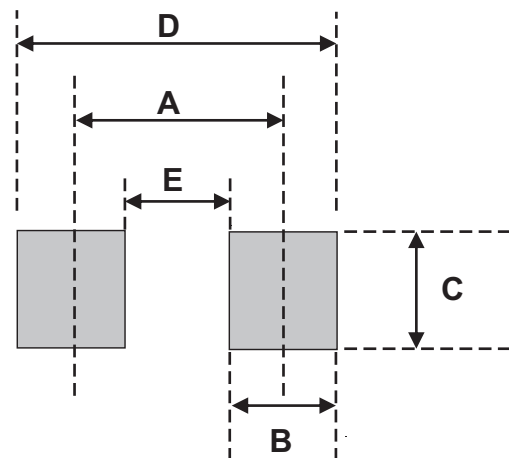

Standard Packaging

Case Type	Qty per Reel	Reel Size
	(Pcs)	(inch)
DO-214AC (SMA)	5000	13

X-ON Electronics

Largest Supplier of Electrical and Electronic Components

Click to view similar products for [Rectifiers](#) category:

Click to view products by [Comchip](#) manufacturer:

Other Similar products are found below :

[70HFR40](#) [RL252-TP](#) [150KR30A](#) [1N5397](#) [NTE5841](#) [NTE6038](#) [SCF5000](#) [1N4002G](#) [1N4005-TR](#) [JANS1N6640US](#) [481235F](#)
[RRE02VS6SGTR](#) [067907F](#) [MS306](#) [70HF40](#) [T110HF60](#) [T85HFL60S02](#) [US2JFL-TP](#) [A1N5404G-G](#) [CRS04\(T5L,TEMQ\)](#) [ACGRA4007-HF](#)
[ACGRB207-HF](#) [CLH03\(TE16L,Q\)](#) [ACGRC307-HF](#) [ACEFC304-HF](#) [NTE6356](#) [NTE6359](#) [NTE6002](#) [NTE6023](#) [NTE6039](#) [NTE6077](#)
[85HFR60](#) [40HFR60](#) [1N1186RA](#) [70HF120](#) [85HFR80](#) [D126A45C](#) [SCF7500](#) [D251N08B](#) [SCHJ22.5K](#) [SM100](#) [SCPA2](#) [SCH10000](#) [SDHD5K](#)
[VS-12FL100S10](#) [ACGRA4001-HF](#) [D1821SH45T PR](#) [D1251S45T](#) [NTE5990](#) [NTE6358](#)