

CZRB5338B-HF Thru. CZRB5388B-HF

Voltage: 5.1V to 200V

Power: 5 W

RoHS Device

Halogen Free

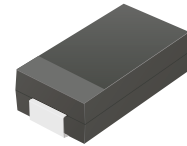

Features

- Glass passivated chip
- Low leakage
- Built-in strain relief
- Low inductance
- High peak reverse power dissipation
- For use in stabilizing and clipping with high power rating.

Mechanical data

- Epoxy: UL 94V-0 rate flame retardant
- Case: Molded plastic
- Lead: Solderable per MIL-STD-202, method 208 guranteed.
- Polarity: Color band denotes cathode end.
- Mounting position: Any

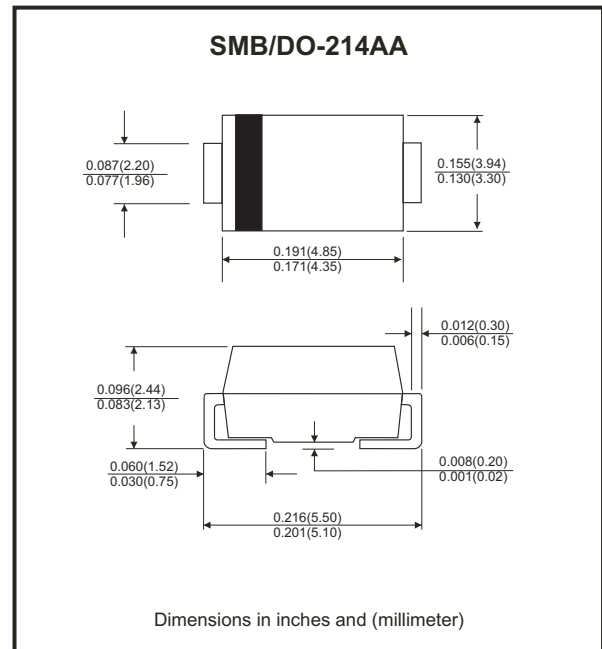

Circuit diagram



Maximum Ratings (TA=25°C unless otherwise noted)

| Parameter | Symbol | Value | Unit |
|--|------------------|-------------|------|
| DC Power dissipation at TL = 50°C (Note 1) | P _D | 5.0 | W |
| Maximum forward voltage at I _F = 200 mA | V _F | 1.2 | V |
| Junction temperature range | T _J | -55 to +150 | °C |
| Storage temperature range | T _{STG} | -55 to +150 | °C |

Note:

(1) TL = Lead temperature at 3/8" (9.5mm) from body.

Rating and Characteristics Curves (CZRB5338B-HF Thru CZRB5388B-HF)

Fig.1 - Power Temperature Derating Curve

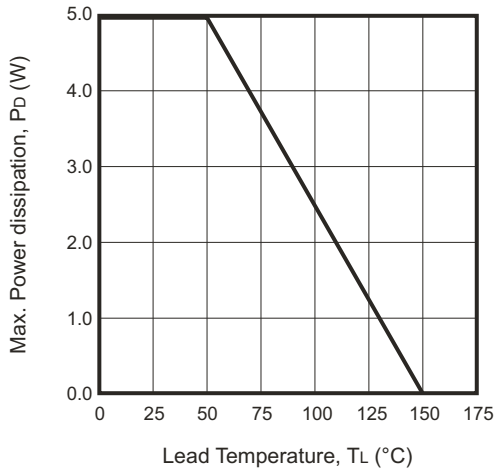

Fig.2 - Temperature Coefficients v.s. Zener Voltage

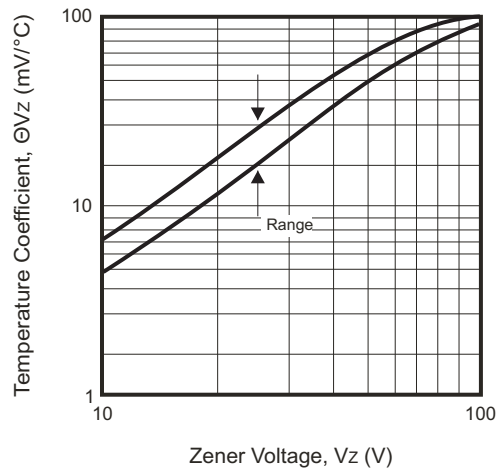

Fig.3 - Typical Thermal Resistance v.s. Lead Length

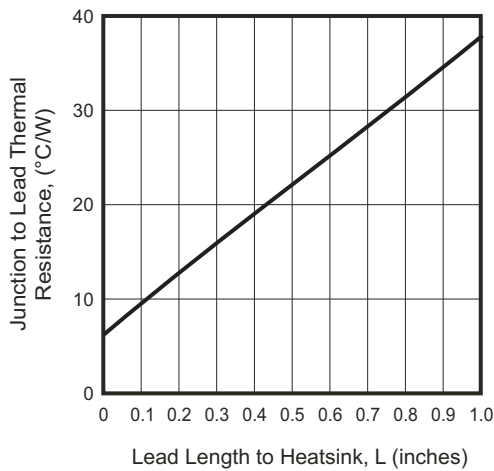

Fig.4 - Maximum Surge Power

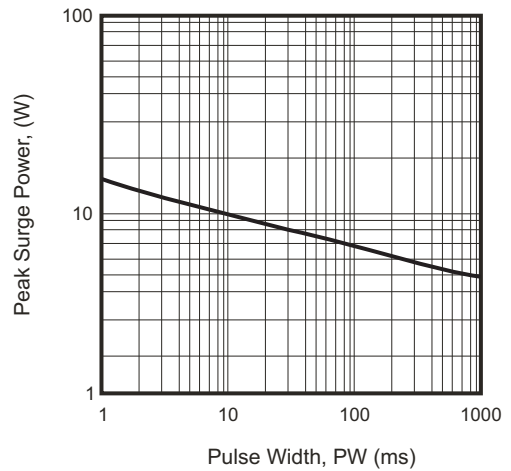
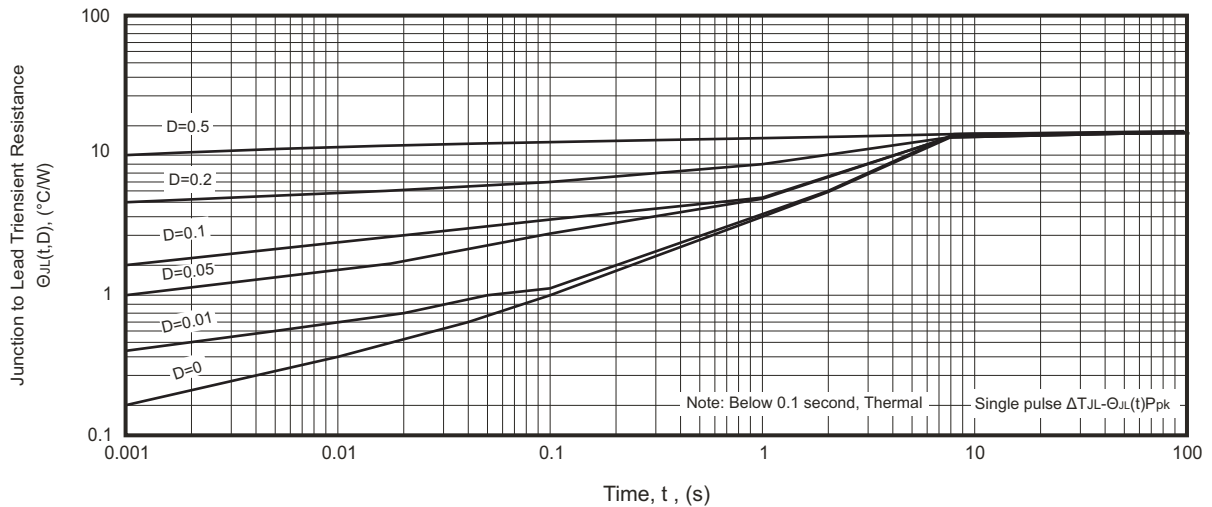

Fig.5 - Typical Thermal Response L, Lead Length=3/8inch



Company reserves the right to improve product design , functions and reliability without notice.

Electrical Characteristics (TA=25°C unless otherwise noted)

| Part Number | Nominal Zener Voltage | | Maximum Zener Impedance | | | Maximum Reverse Leakage Current | | Marking Code |
|--------------|-----------------------|------|-------------------------|-----------|------|---------------------------------|------|--------------|
| | Vz @ IZT | IZT | ZzT @ IZT | Zzk @ Izk | Izk | IR @ VR | | |
| | (V) | (mA) | (Ω) | (Ω) | (mA) | (μA) | (V) | |
| CZRB5338B-HF | 5.1 | 240 | 1.5 | 400 | 1 | 1.0 | 1.0 | 338B |
| CZRB5339B-HF | 5.6 | 220 | 1.0 | 400 | 1 | 1.0 | 2.0 | 339B |
| CZRB5340B-HF | 6.0 | 200 | 1.0 | 300 | 1 | 1.0 | 3.0 | 340B |
| CZRB5341B-HF | 6.2 | 200 | 1.0 | 200 | 1 | 1.0 | 3.0 | 341B |
| CZRB5342B-HF | 6.8 | 175 | 1.0 | 200 | 1 | 10.0 | 5.2 | 342B |
| CZRB5343B-HF | 7.5 | 175 | 1.5 | 200 | 1 | 10.0 | 5.7 | 343B |
| CZRB5344B-HF | 8.2 | 150 | 1.5 | 200 | 1 | 10.0 | 6.2 | 344B |
| CZRB5345B-HF | 8.7 | 150 | 2.0 | 200 | 1 | 10.0 | 6.6 | 345B |
| CZRB5346B-HF | 9.1 | 150 | 2.0 | 150 | 1 | 7.5 | 6.9 | 346B |
| CZRB5347B-HF | 10.0 | 125 | 2.0 | 125 | 1 | 5.0 | 7.6 | 347B |
| CZRB5348B-HF | 11.0 | 125 | 2.5 | 125 | 1 | 5.0 | 8.4 | 348B |
| CZRB5349B-HF | 12.0 | 100 | 2.5 | 125 | 1 | 2.0 | 9.1 | 349B |
| CZRB5350B-HF | 13.0 | 100 | 2.5 | 100 | 1 | 1.0 | 9.9 | 350B |
| CZRB5351B-HF | 14.0 | 100 | 2.5 | 75 | 1 | 1.0 | 10.6 | 351B |
| CZRB5352B-HF | 15.0 | 75 | 2.5 | 75 | 1 | 1.0 | 11.5 | 352B |
| CZRB5353B-HF | 16.0 | 75 | 2.5 | 75 | 1 | 1.0 | 12.2 | 353B |
| CZRB5354B-HF | 17.0 | 70 | 2.5 | 75 | 1 | 0.5 | 12.9 | 354B |
| CZRB5355B-HF | 18.0 | 65 | 2.5 | 75 | 1 | 0.5 | 13.7 | 355B |
| CZRB5356B-HF | 19.0 | 65 | 3.0 | 75 | 1 | 0.5 | 14.4 | 356B |
| CZRB5357B-HF | 20.0 | 65 | 3.0 | 75 | 1 | 0.5 | 15.2 | 357B |
| CZRB5358B-HF | 22.0 | 50 | 3.5 | 75 | 1 | 0.5 | 16.7 | 358B |
| CZRB5359B-HF | 24.0 | 50 | 3.5 | 100 | 1 | 0.5 | 18.2 | 359B |
| CZRB5360B-HF | 25.0 | 50 | 4.0 | 110 | 1 | 0.5 | 19.0 | 360B |
| CZRB5361B-HF | 27.0 | 50 | 5.0 | 120 | 1 | 0.5 | 20.6 | 361B |
| CZRB5362B-HF | 28.0 | 50 | 6.0 | 130 | 1 | 0.5 | 21.2 | 362B |
| CZRB5363B-HF | 30.0 | 40 | 8.0 | 140 | 1 | 0.5 | 22.8 | 363B |

Notes:

- (1) The type number listed have a standard tolerance on the nominal zener voltage of ± 5%.
- (2) The reverse surge current is a non-repetitive, 8.3ms pulse width square wave or equivalent sine-wave superimposed on IZT per JEDEC Method.

Company reserves the right to improve product design, functions and reliability without notice.

REV:A

Electrical Characteristics (TA=25°C unless otherwise noted)

| Part Number | Nominal Zener Voltage | | Maximum Zener Impedance | | | Maximum Reverse Leakage Current | | Marking Code |
|--------------|-----------------------|------|-------------------------|-----------|------|---------------------------------|-------|--------------|
| | Vz @ IZT | IZT | ZzT @ IZT | Zzk @ Izk | Izk | IR @ VR | | |
| | (V) | (mA) | (Ω) | (Ω) | (mA) | (μA) | (V) | |
| CZRB5364B-HF | 33.0 | 40 | 10.0 | 150 | 1 | 0.5 | 25.1 | 364B |
| CZRB5365B-HF | 36.0 | 30 | 11.0 | 160 | 1 | 0.5 | 27.4 | 365B |
| CZRB5366B-HF | 39.0 | 30 | 14.0 | 170 | 1 | 0.5 | 29.7 | 366B |
| CZRB5367B-HF | 43 | 30 | 20 | 190 | 1 | 0.5 | 32.7 | 367B |
| CZRB5368B-HF | 47 | 25 | 25 | 210 | 1 | 0.5 | 35.8 | 368B |
| CZRB5369B-HF | 51 | 25 | 27 | 230 | 1 | 0.5 | 38.8 | 369B |
| CZRB5370B-HF | 56 | 20 | 35 | 280 | 1 | 0.5 | 42.6 | 370B |
| CZRB5371B-HF | 60 | 20 | 40 | 350 | 1 | 0.5 | 42.5 | 371B |
| CZRB5372B-HF | 62 | 20 | 42 | 400 | 1 | 0.5 | 47.1 | 372B |
| CZRB5373B-HF | 68 | 20 | 44 | 500 | 1 | 0.5 | 51.7 | 373B |
| CZRB5374B-HF | 75 | 20 | 45 | 620 | 1 | 0.5 | 56.0 | 374B |
| CZRB5375B-HF | 82 | 15 | 65 | 720 | 1 | 0.5 | 62.2 | 375B |
| CZRB5376B-HF | 87 | 15 | 75 | 760 | 1 | 0.5 | 66.0 | 376B |
| CZRB5377B-HF | 91 | 15 | 75 | 760 | 1 | 0.5 | 69.2 | 377B |
| CZRB5378B-HF | 100 | 12 | 90 | 800 | 1 | 0.5 | 76.0 | 378B |
| CZRB5379B-HF | 110 | 12 | 125 | 1000 | 1 | 0.5 | 83.6 | 379B |
| CZRB5380B-HF | 120 | 10 | 170 | 1150 | 1 | 0.5 | 91.2 | 380B |
| CZRB5381B-HF | 130 | 10 | 190 | 1250 | 1 | 0.5 | 98.8 | 381B |
| CZRB5382B-HF | 140 | 8 | 230 | 1500 | 1 | 0.5 | 106.0 | 382B |
| CZRB5383B-HF | 150 | 8 | 330 | 1500 | 1 | 0.5 | 114.0 | 383B |
| CZRB5384B-HF | 160 | 8 | 350 | 1650 | 1 | 0.5 | 122.0 | 384B |
| CZRB5385B-HF | 170 | 8 | 380 | 1750 | 1 | 0.5 | 129.0 | 385B |
| CZRB5386B-HF | 180 | 5 | 430 | 1750 | 1 | 0.5 | 137.0 | 386B |
| CZRB5387B-HF | 190 | 5 | 450 | 1850 | 1 | 0.5 | 144.0 | 387B |
| CZRB5388B-HF | 200 | 5 | 480 | 1850 | 1 | 0.5 | 152.0 | 388B |

Notes:

- (1) The type number listed have a standard tolerance on the nominal zener voltage of ± 5%.
- (2) The reverse surge current is a non-repetitive, 8.3ms pulse width square wave or equivalent sine-wave superimposed on IZT per JEDEC Method.

Company reserves the right to improve product design, functions and reliability without notice.

REV:A

Reel Taping Specification

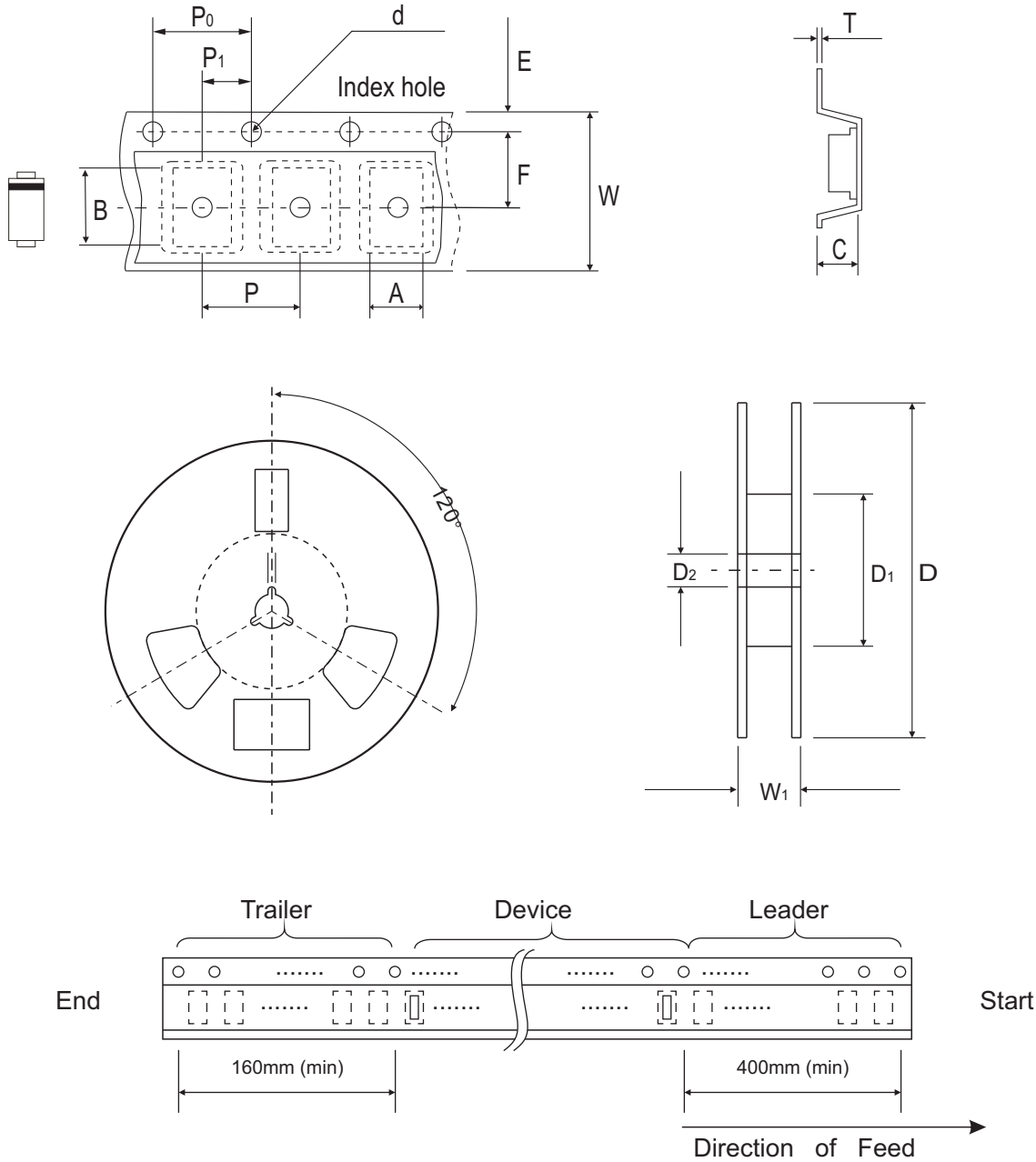

| DO-214AA (SMB) | SYMBOL | A | B | C | d | D | D1 | D2 |
|-------------------|--------|---------------|---------------|---------------|---------------|---------------|------------|---------------|
| | (mm) | 3.67 ± 0.10 | 5.69 ± 0.10 | 2.67 ± 0.10 | 1.55 ± 0.10 | 330.00 ± 2.00 | 50.00 MIN. | 13.00 ± 0.20 |
| | (inch) | 0.144 ± 0.004 | 0.224 ± 0.004 | 0.105 ± 0.004 | 0.061 ± 0.004 | 12.99 ± 0.079 | 1.969 MIN. | 0.512 ± 0.008 |

| DO-214AA (SMB) | SYMBOL | E | F | P | P0 | P1 | t | W | W1 |
|-------------------|--------|---------------|---------------|---------------|---------------|---------------|-------------|---------------|-------------|
| | (mm) | 1.75 ± 0.10 | 5.50 ± 0.05 | 8.00 ± 0.10 | 4.00 ± 0.10 | 2.00 ± 0.05 | 0.40 (MAX) | 12.00 ± 0.30 | 18.40 (MAX) |
| | (inch) | 0.069 ± 0.004 | 0.217 ± 0.002 | 0.315 ± 0.004 | 0.157 ± 0.004 | 0.079 ± 0.002 | 0.016 (MAX) | 0.472 ± 0.012 | 0.724 (MAX) |

Company reserves the right to improve product design, functions and reliability without notice.

REV:A

Marking Code



- 1. XXX : Marking code (see Page.3~4)
- 2. : Cathod Band

Suggested PAD Layout

| SIZE | DO-214AA(SMB) | |
|------|---------------|-----------|
| | (mm) | (inch) |
| A | 5.60 | 0.220 |
| B | 2.16 MAX | 0.085 MAX |
| C | 1.52 MIN | 0.060 MIN |
| D | 2.18 MIN | 0.086 MIN |

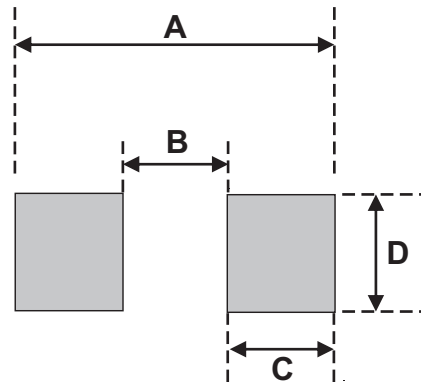

Standard Packaging

| Case Type | REEL PACK | |
|----------------|--------------|------------------|
| | REEL (pcs) | Reel Size (inch) |
| DO-214AA (SMB) | 3,000 | 13 |

X-ON Electronics

Largest Supplier of Electrical and Electronic Components

Click to view similar products for [Zener Diodes](#) category:

Click to view products by [Comchip](#) manufacturer:

Other Similar products are found below :

[RKZ13B2KG#P1](#) [DL5234B](#) [1N4682](#) [1N4691](#) [1N4693](#) [1N4732A](#) [1N4733A-TR](#) [1N4736A](#) [1N4750A](#) [1N4759ARL](#) [1N5241B](#) [1N5365B](#)
[1N5369B](#) [1N747A](#) [1N959B](#) [1N964B](#) [1N966B](#) [1N968B](#) [1N972B](#) [NTE149A](#) [NTE5116A](#) [NTE5121A](#) [NTE5147A](#) [NTE5152A](#) [NTE5155A](#)
[NTE5164A](#) [JANS1N4974US](#) [1N4692](#) [1N4700](#) [1N4702](#) [1N4704](#) [1N4711](#) [1N4714](#) [1N4737A](#) [1N4745ARL](#) [1N4752A](#) [1N4752ARL](#)
[1N4760ARL](#) [1N5221B](#) [1N5236B](#) [1N5241BTR](#) [1N5242BTR](#) [1N5350B](#) [1N5352B](#) [1N961BRR1](#) [1N964BRL](#) [RKZ5.1BKU#P6](#)
[3SMAJ5950B-TP](#) [3SMBJ5925B-TP](#) [TDZTR24](#)