

CZRB5338B-HF Thru. CZRB5388B-HF

Voltage: 5.1V to 200V

Power: 5 W

RoHS Device

Halogen Free

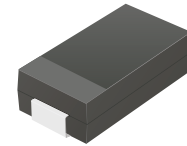

Features

- Glass passivated chip
- Low leakage
- Built-in strain relief
- Low inductance
- High peak reverse power dissipation
- For use in stabilizing and clipping with high power rating.

Mechanical data

- Epoxy: UL 94V-0 rate flame retardant
- Case: Molded plastic
- Lead: Solderable per MIL-STD-202, method 208 guaranteed.
- Polarity: Color band denotes cathode end.
- Mounting position: Any

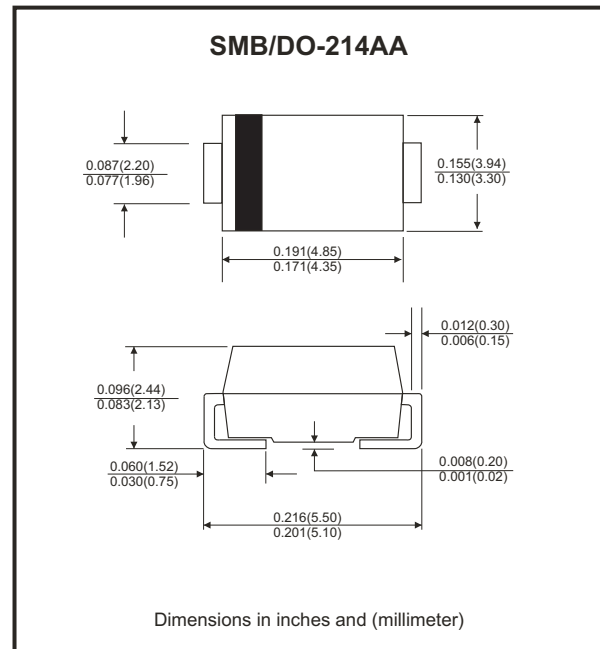

Circuit diagram



Maximum Ratings (TA=25°C unless otherwise noted)

Parameter	Symbol	Value	Unit
DC Power dissipation at TL = 50°C (Note 1)	P _D	5.0	W
Maximum forward voltage at I _F = 200 mA	V _F	1.2	V
Junction temperature range	T _J	-55 to +150	°C
Storage temperature range	T _{STG}	-55 to +150	°C

Note:

(1) TL = Lead temperature at 3/8" (9.5mm) from body.

Rating and Characteristics Curves (CZRB5338B-HF Thru CZRB5388B-HF)

Fig.1 - Power Temperature Derating Curve

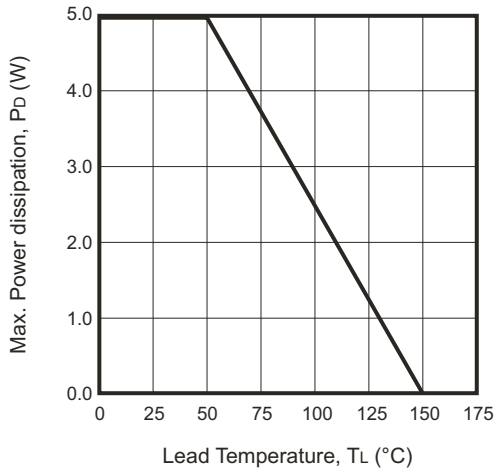

Fig.2 - Temperature Coefficients v.s. Zener Voltage

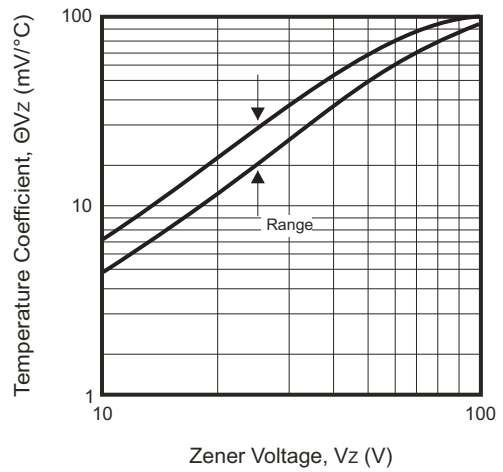

Fig.3 - Typical Thermal Resistance v.s. Lead Length

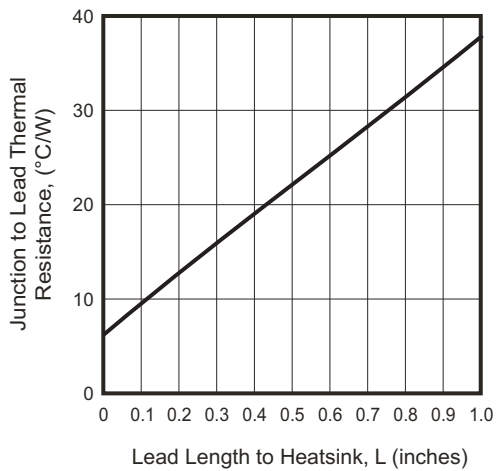

Fig.4 - Maximum Surge Power

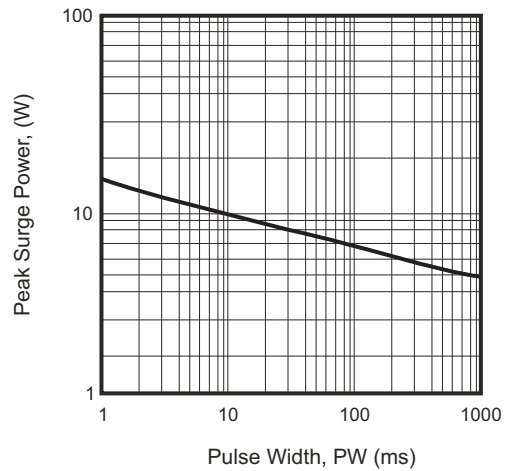
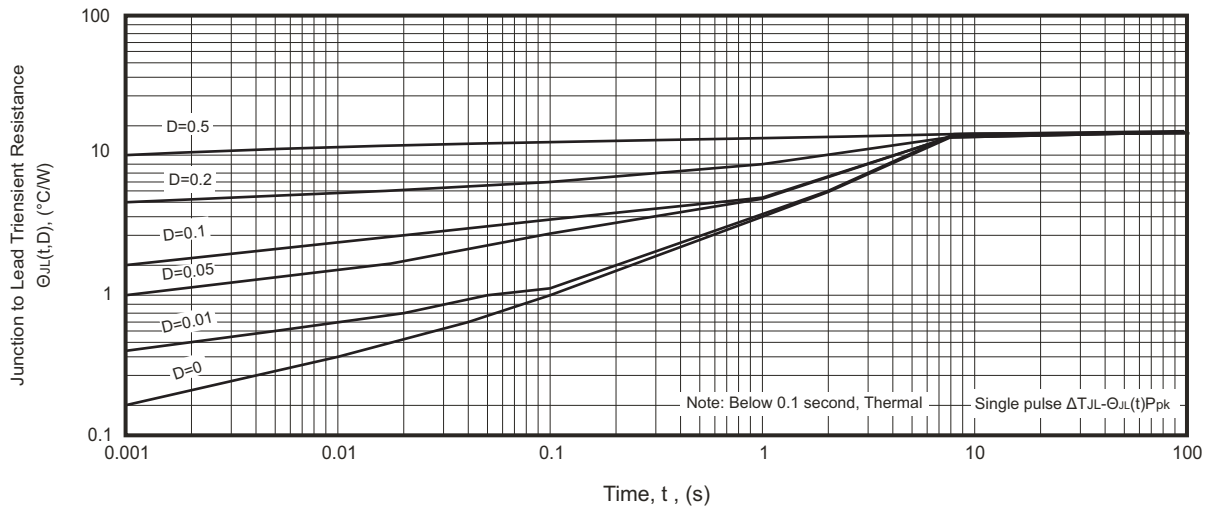

Fig.5 - Typical Thermal Response L, Lead Length=3/8inch



Company reserves the right to improve product design , functions and reliability without notice.

REV:A

Electrical Characteristics (TA=25°C unless otherwise noted)

Part Number	Nominal Zener Voltage		Maximum Zener Impedance			Maximum Reverse Leakage Current		Marking Code
	Vz @ IZT	IZT	ZzT @ IZT	Zzk @ Izk	Izk	IR @ VR		
	(V)	(mA)	(Ω)	(Ω)	(mA)	(μA)	(V)	
CZRB5338B-HF	5.1	240	1.5	400	1	1.0	1.0	338B
CZRB5339B-HF	5.6	220	1.0	400	1	1.0	2.0	339B
CZRB5340B-HF	6.0	200	1.0	300	1	1.0	3.0	340B
CZRB5341B-HF	6.2	200	1.0	200	1	1.0	3.0	341B
CZRB5342B-HF	6.8	175	1.0	200	1	10.0	5.2	342B
CZRB5343B-HF	7.5	175	1.5	200	1	10.0	5.7	343B
CZRB5344B-HF	8.2	150	1.5	200	1	10.0	6.2	344B
CZRB5345B-HF	8.7	150	2.0	200	1	10.0	6.6	345B
CZRB5346B-HF	9.1	150	2.0	150	1	7.5	6.9	346B
CZRB5347B-HF	10.0	125	2.0	125	1	5.0	7.6	347B
CZRB5348B-HF	11.0	125	2.5	125	1	5.0	8.4	348B
CZRB5349B-HF	12.0	100	2.5	125	1	2.0	9.1	349B
CZRB5350B-HF	13.0	100	2.5	100	1	1.0	9.9	350B
CZRB5351B-HF	14.0	100	2.5	75	1	1.0	10.6	351B
CZRB5352B-HF	15.0	75	2.5	75	1	1.0	11.5	352B
CZRB5353B-HF	16.0	75	2.5	75	1	1.0	12.2	353B
CZRB5354B-HF	17.0	70	2.5	75	1	0.5	12.9	354B
CZRB5355B-HF	18.0	65	2.5	75	1	0.5	13.7	355B
CZRB5356B-HF	19.0	65	3.0	75	1	0.5	14.4	356B
CZRB5357B-HF	20.0	65	3.0	75	1	0.5	15.2	357B
CZRB5358B-HF	22.0	50	3.5	75	1	0.5	16.7	358B
CZRB5359B-HF	24.0	50	3.5	100	1	0.5	18.2	359B
CZRB5360B-HF	25.0	50	4.0	110	1	0.5	19.0	360B
CZRB5361B-HF	27.0	50	5.0	120	1	0.5	20.6	361B
CZRB5362B-HF	28.0	50	6.0	130	1	0.5	21.2	362B
CZRB5363B-HF	30.0	40	8.0	140	1	0.5	22.8	363B

Notes:

- (1) The type number listed have a standard tolerance on the nominal zener voltage of ± 5%.
- (2) The reverse surge current is a non-repetitive, 8.3ms pulse width square wave or equivalent sine-wave superimposed on IZT per JEDEC Method.

Company reserves the right to improve product design, functions and reliability without notice.

REV:A

Electrical Characteristics (TA=25°C unless otherwise noted)

Part Number	Nominal Zener Voltage		Maximum Zener Impedance			Maximum Reverse Leakage Current		Marking Code
	Vz @ IZT	IZT	ZzT @ IZT	Zzk @ Izk	Izk	IR @ VR		
	(V)	(mA)	(Ω)	(Ω)	(mA)	(μA)	(V)	
CZRB5364B-HF	33.0	40	10.0	150	1	0.5	25.1	364B
CZRB5365B-HF	36.0	30	11.0	160	1	0.5	27.4	365B
CZRB5366B-HF	39.0	30	14.0	170	1	0.5	29.7	366B
CZRB5367B-HF	43	30	20	190	1	0.5	32.7	367B
CZRB5368B-HF	47	25	25	210	1	0.5	35.8	368B
CZRB5369B-HF	51	25	27	230	1	0.5	38.8	369B
CZRB5370B-HF	56	20	35	280	1	0.5	42.6	370B
CZRB5371B-HF	60	20	40	350	1	0.5	42.5	371B
CZRB5372B-HF	62	20	42	400	1	0.5	47.1	372B
CZRB5373B-HF	68	20	44	500	1	0.5	51.7	373B
CZRB5374B-HF	75	20	45	620	1	0.5	56.0	374B
CZRB5375B-HF	82	15	65	720	1	0.5	62.2	375B
CZRB5376B-HF	87	15	75	760	1	0.5	66.0	376B
CZRB5377B-HF	91	15	75	760	1	0.5	69.2	377B
CZRB5378B-HF	100	12	90	800	1	0.5	76.0	378B
CZRB5379B-HF	110	12	125	1000	1	0.5	83.6	379B
CZRB5380B-HF	120	10	170	1150	1	0.5	91.2	380B
CZRB5381B-HF	130	10	190	1250	1	0.5	98.8	381B
CZRB5382B-HF	140	8	230	1500	1	0.5	106.0	382B
CZRB5383B-HF	150	8	330	1500	1	0.5	114.0	383B
CZRB5384B-HF	160	8	350	1650	1	0.5	122.0	384B
CZRB5385B-HF	170	8	380	1750	1	0.5	129.0	385B
CZRB5386B-HF	180	5	430	1750	1	0.5	137.0	386B
CZRB5387B-HF	190	5	450	1850	1	0.5	144.0	387B
CZRB5388B-HF	200	5	480	1850	1	0.5	152.0	388B

Notes:

- (1) The type number listed have a standard tolerance on the nominal zener voltage of ± 5%.
- (2) The reverse surge current is a non-repetitive, 8.3ms pulse width square wave or equivalent sine-wave superimposed on IZT per JEDEC Method.

Company reserves the right to improve product design, functions and reliability without notice.

REV:A

Reel Taping Specification

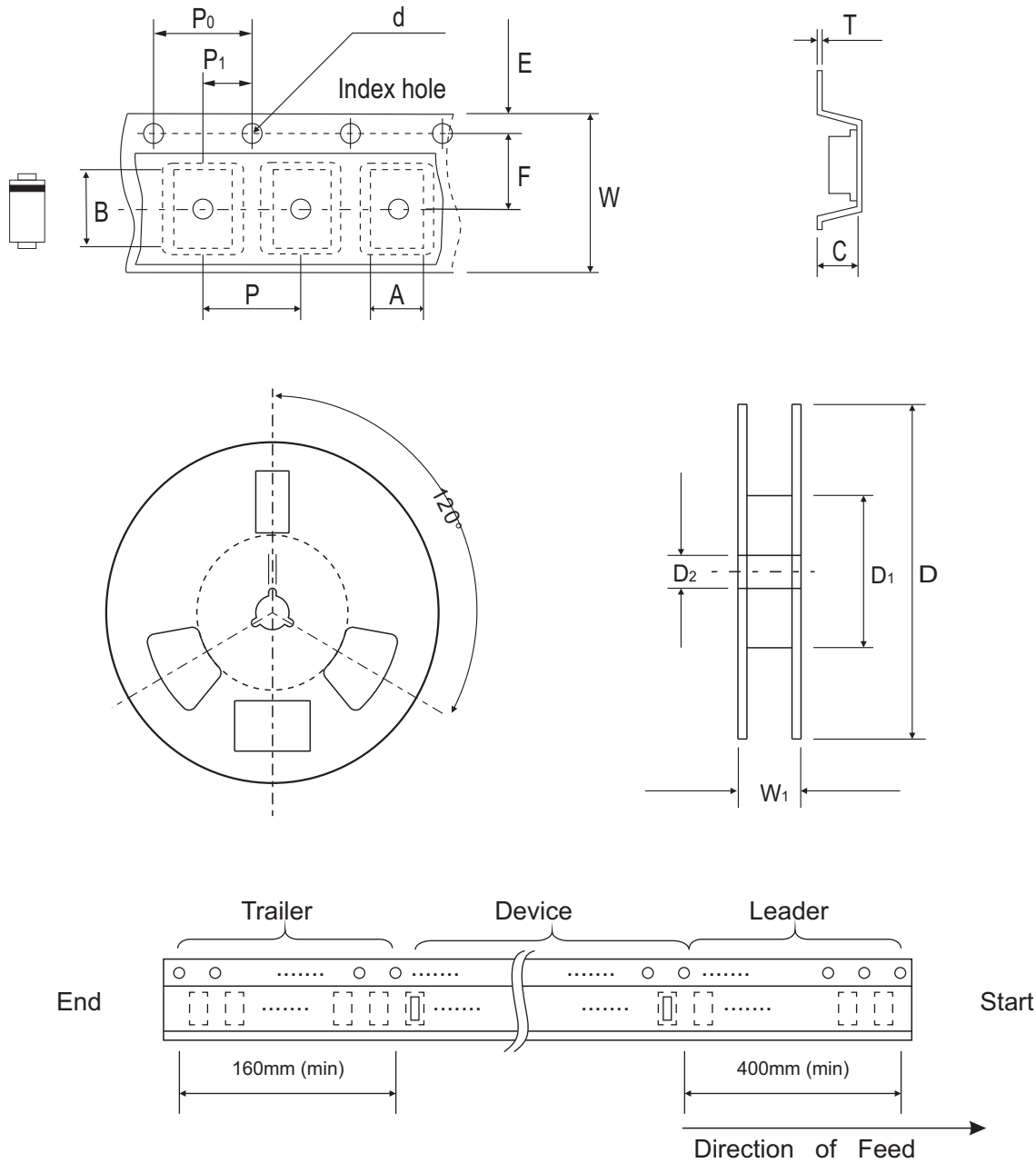

DO-214AA (SMB)	SYMBOL	A	B	C	d	D	D1	D2
	(mm)	3.67 ± 0.10	5.69 ± 0.10	2.67 ± 0.10	1.55 ± 0.10	330.00 ± 2.00	50.00 MIN.	13.00 ± 0.20
	(inch)	0.144 ± 0.004	0.224 ± 0.004	0.105 ± 0.004	0.061 ± 0.004	12.99 ± 0.079	1.969 MIN.	0.512 ± 0.008

DO-214AA (SMB)	SYMBOL	E	F	P	P0	P1	t	W	W1
	(mm)	1.75 ± 0.10	5.50 ± 0.05	8.00 ± 0.10	4.00 ± 0.10	2.00 ± 0.05	0.40 (MAX)	12.00 ± 0.30	18.40 (MAX)
	(inch)	0.069 ± 0.004	0.217 ± 0.002	0.315 ± 0.004	0.157 ± 0.004	0.079 ± 0.002	0.016 (MAX)	0.472 ± 0.012	0.724 (MAX)

Company reserves the right to improve product design, functions and reliability without notice.

REV:A

Marking Code



1. XXX : Marking code (see Page.3~4)

2. : Cathod Band

Suggested PAD Layout

SIZE	DO-214AA(SMB)	
	(mm)	(inch)
A	5.60	0.220
B	2.16 MAX	0.085 MAX
C	1.52 MIN	0.060 MIN
D	2.18 MIN	0.086 MIN

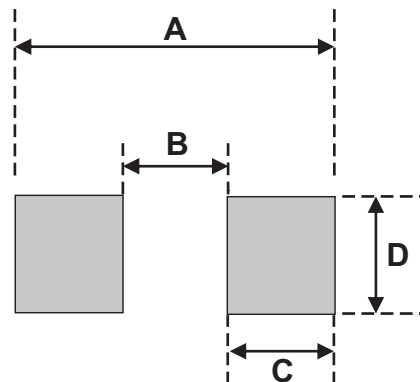

Standard Packaging

Case Type	REEL PACK	
	REEL (pcs)	Reel Size (inch)
DO-214AA (SMB)	3,000	13

X-ON Electronics

Largest Supplier of Electrical and Electronic Components

Click to view similar products for [Zener Diodes](#) category:

Click to view products by [Comchip](#) manufacturer:

Other Similar products are found below :

[RKZ13B2KG#P1](#) [DL5234B](#) [1N4682](#) [1N4691](#) [1N4693](#) [1N4732A](#) [1N4733A-TR](#) [1N4736A](#) [1N4750A](#) [1N4759ARL](#) [1N5241B](#) [1N5365B](#)
[1N5369B](#) [1N747A](#) [1N959B](#) [1N964B](#) [1N966B](#) [1N968B](#) [1N972B](#) [NTE149A](#) [NTE5116A](#) [NTE5121A](#) [NTE5147A](#) [NTE5152A](#) [NTE5155A](#)
[NTE5164A](#) [JANS1N4974US](#) [1N4692](#) [1N4700](#) [1N4702](#) [1N4704](#) [1N4711](#) [1N4714](#) [1N4737A](#) [1N4745ARL](#) [1N4752A](#) [1N4752ARL](#)
[1N4760ARL](#) [1N5221B](#) [1N5236B](#) [1N5241BTR](#) [1N5242BTR](#) [1N5350B](#) [1N5352B](#) [1N961BRR1](#) [1N964BRL](#) [RKZ5.1BKU#P6](#)
[3SMAJ5950B-TP](#) [3SMBJ5925B-TP](#) [TDZTR24](#)