

CZRER52C2 Thru CZRER52C39

Voltage 2 to 39 Volts

Power 150 mWatts

RoHS Device

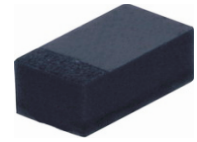

Features

- 150mW Power Dissipation.
- High Voltages from 2 ~ 39 V.
- Designed for mounting on small surface.
- Extremely thin/leadless package.
- Pb free product.

Mechanical data

- Case: 0503/SOD-723F Standard package
Molded plastic.
- Terminals: Gold plated, solderable per
MIL-STD-750,method 2026.
- Polarity: Indicated by cathode band.
- Weight: 0.002 gram(approx.).

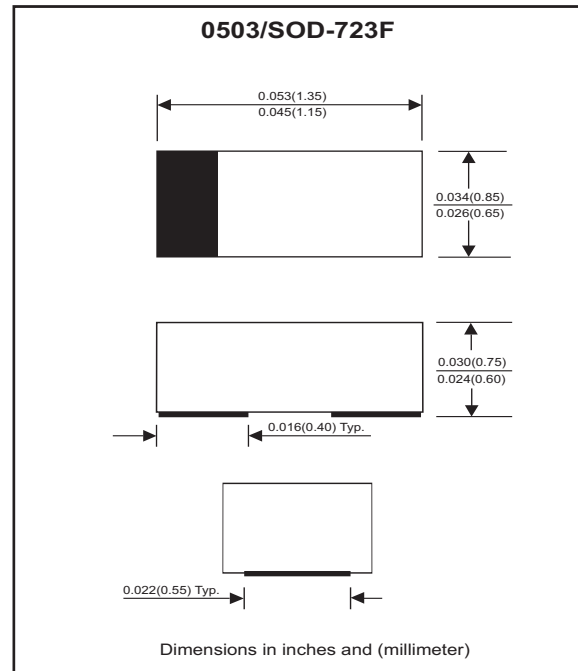

Maximum Rating AND Electrical Characteristics

Parameter	Symbol	Value	Unit
Maximum Forward Voltage Drop at $I_F = 10 \text{ mA}$	V_F	0.9	V
Maximum Power Dissipation at 25 C°	P_D	150	mW
Forward current , surge peak 8.3 ms single half sine-wave superimposed on rate load(JEDEC method)	I_{FSM}	2.0	A
Peak ESD voltage capability (IEC 61000-4-2)	V_{PV}	8	kV
Operating Junction and Storage Temperature Range	T_J	-55 to +125	$^\circ\text{C}$

Electrical Characteristics (TA=25 °C)

Part Number	Marking Code	Zener Voltage			Operating resistance		Rising operating Resistance		Reverse current	
		V _Z (V)			ZZT(Ohm)		ZZK(Ohm)		IR(μA)	
		Min	Max	I _Z (mA)	Max	I _Z (mA)	Max	I _Z (mA)	Max	V _R (V)
CZRER52C2	Z0	1.90	2.10	5	100	5	600	1	100	1
CZRER52C2V2	Z1	2.09	2.31	5	100	5	600	1	100	1
CZRER52C2V4	Z2	2.28	2.52	5	85	5	600	1	100	1
CZRER52C2V7	Z3	2.57	2.84	5	83	5	500	1	75	1
CZRER52C3	Z4	2.85	3.15	5	95	5	500	1	50	1
CZRER52C3V3	Z5	3.14	3.47	5	95	5	500	1	25	1
CZRER52C3V6	Z6	3.42	3.78	5	95	5	500	1	15	1
CZRER52C3V9	Z7	3.71	4.10	5	95	5	500	1	10	1
CZRER52C4V3	Z8	4.09	4.52	5	95	5	500	1	5	1
CZRER52C4V7	Z9	4.47	4.94	5	78	5	500	1	5	2
CZRER52C5V1	ZA	4.85	5.36	5	60	5	480	1	0.1	0.8
CZRER52C5V6	ZB	5.32	5.88	5	40	5	400	1	0.1	1
CZRER52C6V2	ZC	5.89	6.51	5	10	5	200	1	0.1	2
CZRER52C6V8	ZE	6.46	7.14	5	8	5	150	1	0.1	3
CZRER52C7V5	ZF	7.13	7.88	5	7	5	50	1	0.1	5
CZRER52C8V2	ZG	7.79	8.61	5	7	5	50	1	0.1	6
CZRER52C9V1	ZH	8.65	9.56	5	10	5	50	1	0.1	7
CZRER52C10	ZJ	9.50	10.50	5	15	5	70	1	0.1	7.5
CZRER52C11	ZK	10.45	11.55	5	20	5	70	1	0.1	8.5
CZRER52C12	ZM	11.40	12.60	5	20	5	90	1	0.1	9
CZRER52C13	ZN	12.35	13.65	5	25	5	110	1	0.1	10
CZRER52C15	ZP	14.25	15.75	5	30	5	110	1	0.1	11
CZRER52C16	ZQ	15.20	16.80	5	40	5	170	1	0.1	12
CZRER52C18	ZR	17.10	18.90	5	50	5	170	1	0.1	14
CZRER52C20	ZS	19.00	21.00	5	50	5	220	1	0.1	15
CZRER52C22	ZT	20.90	23.10	5	55	5	220	1	0.1	17
CZRER52C24	ZU	22.80	25.20	5	80	5	220	1	0.1	18
CZRER52C27	ZV	25.65	28.35	5	80	5	250	1	0.1	20
CZRER52C30	ZW	28.50	31.50	5	80	5	250	1	0.1	23
CZRER52C33	ZX	31.35	34.65	5	80	5	250	1	0.1	25
CZRER52C36	ZY	34.20	37.80	5	90	5	250	1	0.1	27
CZRER52C39	ZZ	37.05	40.95	5	90	5	300	1	0.1	29

RATING AND CHARACTERISTIC CURVES (CZRER52C2 Thru CZRER52C39)

Fig.1 TEMPERATURE COEFFICIENTS

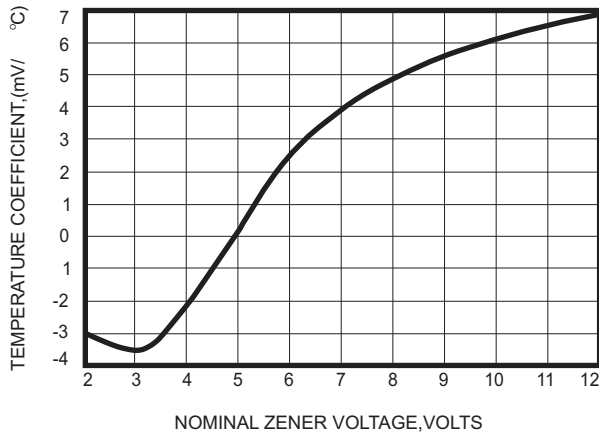

Fig.2 TEMPERATURE COEFFICIENTS

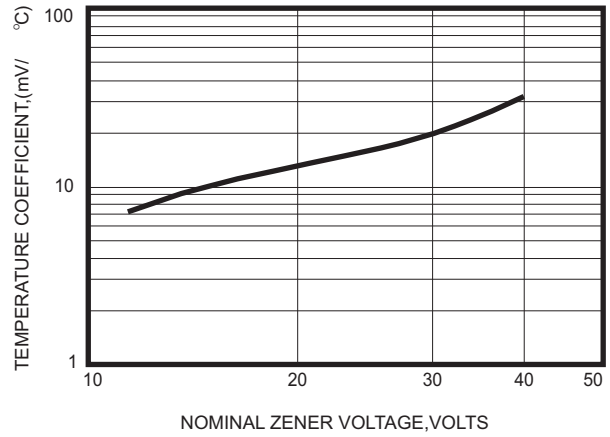

Fig.3 EFFECT OF ZENER VOLTAGE ON ZENER IMPEDANCE

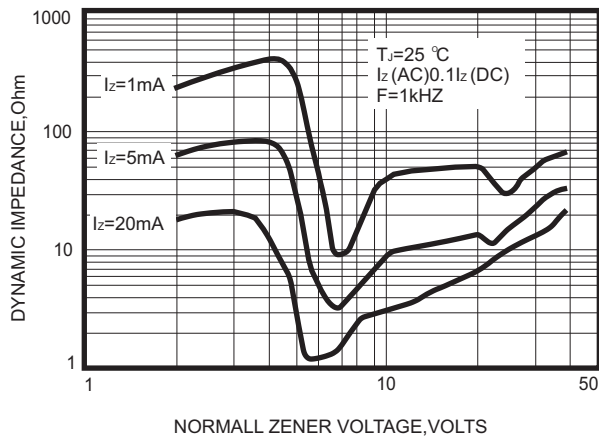

Fig.4 TYPICAL FORWARD VOLTAGE

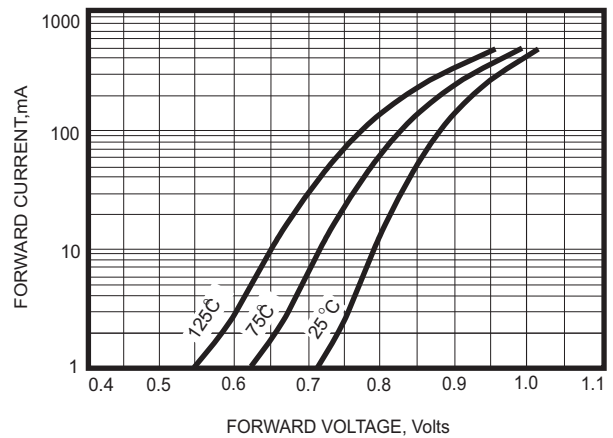

Fig.5 TYPICAL LEAKAGE CURRENT

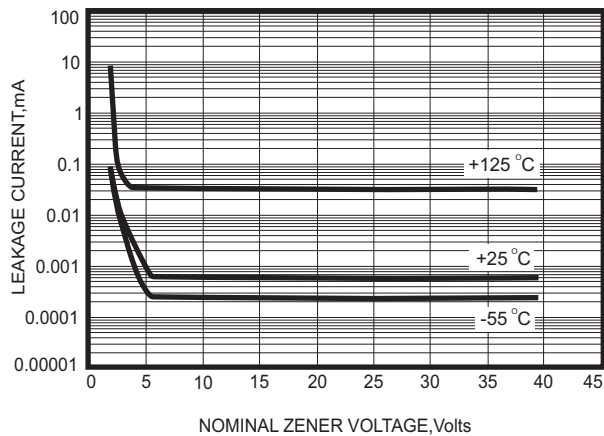
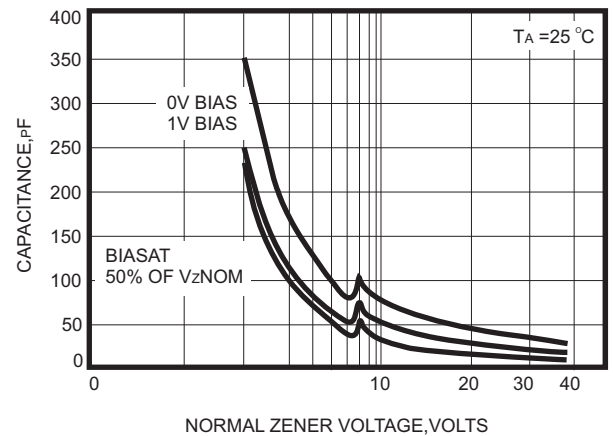

Fig.6 TYPICAL CAPACITANCE



RATING AND CHARACTERISTIC CURVES (CZRER52C2 Thru CZRER52C39)

Fig.7 ZENER VOLTAGE VERSUS ZENER CURRENT

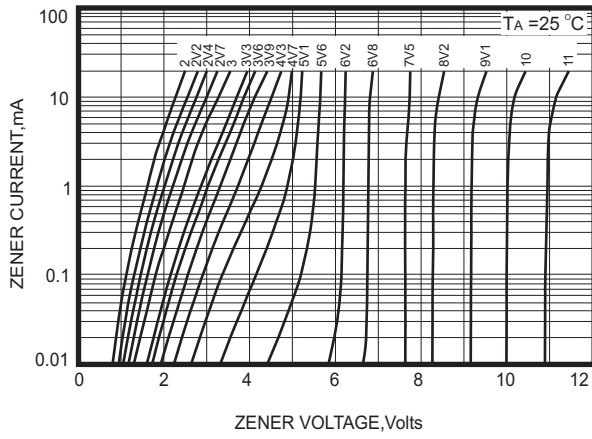

Fig.8 ZENER VOLTAGE VERSUS ZENER CURRENT

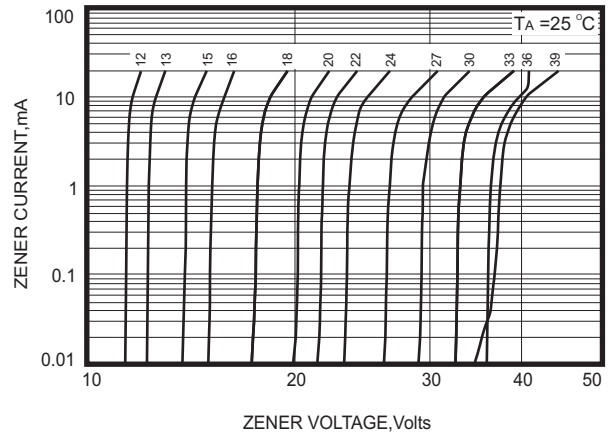
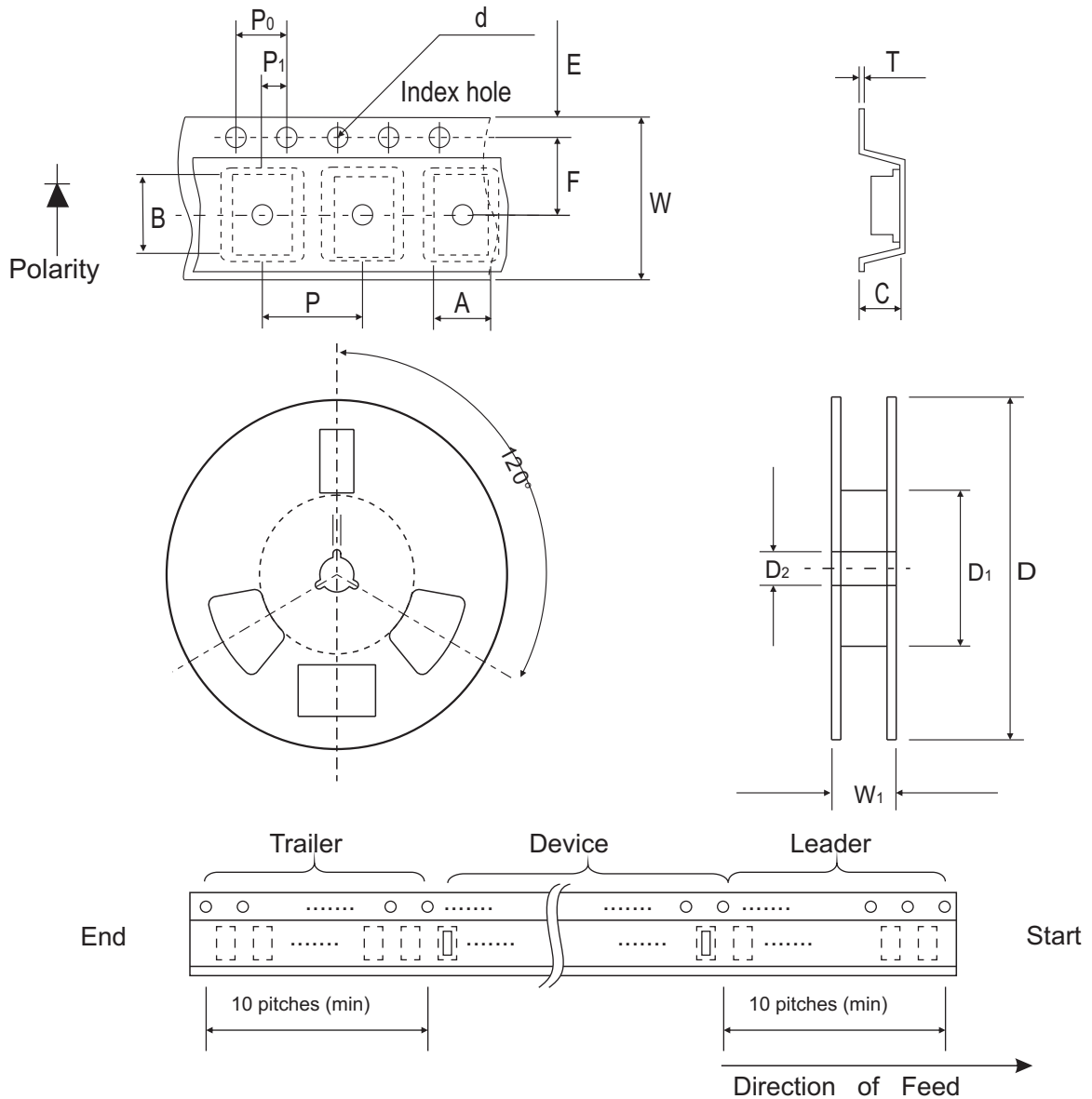

Fig.9 STEADY STATE POWER DERATING



Reel Taping Specification



0503 (SOD-723F)	SYMBOL	A	B	C	d	D	D ₁	D ₂
	(mm)	0.90 ± 0.10	1.46 ± 0.10	0.80 ± 0.10	1.55 ± 0.05	178 ± 1	60.0 MIN.	13.0 ± 0.20
	(inch)	0.035 ± 0.004	0.057 ± 0.004	0.031 ± 0.004	0.061 ± 0.002	7.008 ± 0.04	2.362 MIN.	0.512 ± 0.008

0503 (SOD-723F)	SYMBOL	E	F	P	P ₀	P ₁	T	W	W ₁
	(mm)	1.75 ± 0.10	3.50 ± 0.05	4.00 ± 0.10	4.00 ± 0.10	2.00 ± 0.10	0.22 ± 0.05	8.00 ± 0.20	13.5 MAX.
	(inch)	0.069 ± 0.004	0.138 ± 0.002	0.157 ± 0.004	0.157 ± 0.004	0.079 ± 0.004	0.008 ± 0.002	0.315 ± 0.008	0.531 MAX.

Suggested PAD Layout

SIZE	0503/SOD-723F	
	(mm)	(inch)
A	0.85	0.033
B	0.55	0.022
C	0.85	0.033
D	1.40	0.055
E	0.30	0.012

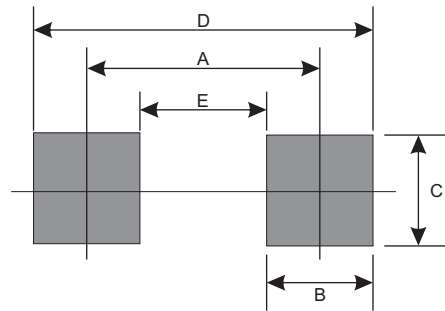

Standard Package

Case Type	Qty per Reel	Reel Size
	(Pcs)	(inch)
0503/SOD-723F	4000	7

X-ON Electronics

Largest Supplier of Electrical and Electronic Components

Click to view similar products for [Zener Diodes](#) category:

Click to view products by [Comchip](#) manufacturer:

Other Similar products are found below :

[RKZ13B2KG#P1](#) [DL5234B](#) [1N4682](#) [1N4691](#) [1N4693](#) [1N4732A](#) [1N4733A-TR](#) [1N4736A](#) [1N4750A](#) [1N4759ARL](#) [1N5241B](#) [1N5365B](#)
[1N5369B](#) [1N747A](#) [1N959B](#) [1N964B](#) [1N966B](#) [1N968B](#) [1N972B](#) [NTE149A](#) [NTE5116A](#) [NTE5121A](#) [NTE5147A](#) [NTE5152A](#) [NTE5155A](#)
[NTE5164A](#) [JANS1N4974US](#) [1N4692](#) [1N4700](#) [1N4702](#) [1N4704](#) [1N4711](#) [1N4714](#) [1N4737A](#) [1N4745ARL](#) [1N4752A](#) [1N4752ARL](#)
[1N4760ARL](#) [1N5221B](#) [1N5236B](#) [1N5241BTR](#) [1N5242BTR](#) [1N5350B](#) [1N5352B](#) [1N961BRR1](#) [1N964BRL](#) [RKZ5.1BKU#P6](#)
[3SMAJ5950B-TP](#) [3SMBJ5925B-TP](#) [TDZTR24](#)