

CZRQR52C2-HF Thru. CZRQR52C39-HF

Voltage 2 to 39 Volts

Power 125 mWatts

RoHS Device

Halogen Free

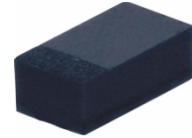

Features

- 125mW Power Dissipation.
- High Voltages from 2 ~ 39 V.
- Designed for mounting on small surface.
- Extremely thin/leadless package.
- Pb free product.

Mechanical data

- Case: 0402/SOD-923F standard package
Molded plastic.
- Terminals: Gold plated, solderable per MIL-STD-750,method 2026.
- Polarity: Indicated by cathode band.
- Weight: 0.001 grams(approx.).

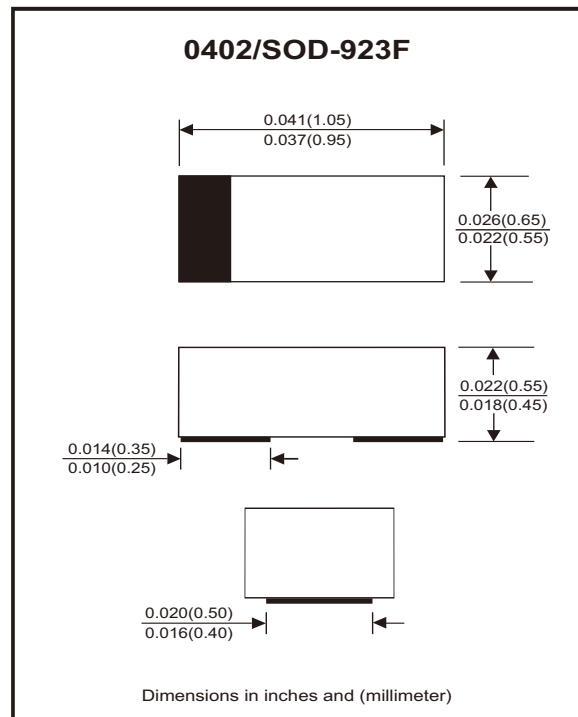

Circuit diagram



Maximum Rating And Electrical Characteristics

Parameter	Symbol	Value	Unit
Maximum Forward Voltage Drop at $I_F = 10 \text{ mA}$	V_F	0.9	V
Maximum Power Dissipation at 25 °C	P_D	125	mW
Forward current , surge peak 8.3 ms single half sine-wave superimposed on rate load(JEDEC method)	I_{FSM}	2.0	A
Peak ESD voltage capability (IEC 61000-4-2)	V_{PV}	8	kV
Operating Junction and Storage Temperature Range	T_J	-55 to +125	°C

Electrical Characteristics (at TA=25°C unless otherwise noted)

Part Number	Marking Code	Zener Voltage				Operating resistance		Rising operating Resistance		Reverse current	
		Vz (V)				ZzT (Ω)		Zzk (Ω)		IR (uA)	
		Min	Typ	Max	Iz (mA)	Max	Iz (mA)	Max	Iz (mA)	Max	VR (V)
CZRQR52C2-HF	Z0	1.90	2.0	2.10	5	100	5	600	1	100	1
CZRQR52C2V2-HF	Z1	2.09	2.2	2.31	5	100	5	600	1	100	1
CZRQR52C2V4-HF	Z2	2.28	2.4	2.52	5	85	5	600	1	100	1
CZRQR52C2V7-HF	Z3	2.57	2.7	2.84	5	83	5	500	1	75	1
CZRQR52C3-HF	Z4	2.85	3.0	3.15	5	95	5	500	1	50	1
CZRQR52C3V3-HF	Z5	3.14	3.3	3.47	5	95	5	500	1	25	1
CZRQR52C3V6-HF	Z6	3.42	3.6	3.78	5	95	5	500	1	15	1
CZRQR52C3V9-HF	Z7	3.71	3.9	4.10	5	95	5	500	1	10	1
CZRQR52C4V3-HF	Z8	4.09	4.3	4.52	5	95	5	500	1	5	1
CZRQR52C4V7-HF	Z9	4.47	4.7	4.94	5	78	5	500	1	5	2
CZRQR52C5V1-HF	ZA	4.85	5.1	5.36	5	60	5	480	1	0.1	0.8
CZRQR52C5V6-HF	ZB	5.32	5.6	5.88	5	40	5	400	1	0.1	1
CZRQR52C6V2-HF	ZC	5.89	6.2	6.51	5	10	5	200	1	0.1	2
CZRQR52C6V8-HF	ZE	6.46	6.8	7.14	5	8	5	150	1	0.1	3
CZRQR52C7V5-HF	ZF	7.13	7.5	7.88	5	7	5	50	1	0.1	5
CZRQR52C8V2-HF	ZG	7.79	8.2	8.61	5	7	5	50	1	0.1	6
CZRQR52C9V1-HF	ZH	8.65	9.1	9.56	5	10	5	50	1	0.1	7
CZRQR52C10-HF	ZJ	9.50	10	10.50	5	15	5	70	1	0.1	7.5
CZRQR52C11-HF	ZK	10.45	11	11.55	5	20	5	70	1	0.1	8.5
CZRQR52C12-HF	ZM	11.40	12	12.60	5	20	5	90	1	0.1	9
CZRQR52C13-HF	ZN	12.35	13	13.65	5	25	5	110	1	0.1	10
CZRQR52C15-HF	ZP	14.25	15	15.75	5	30	5	110	1	0.1	11
CZRQR52C16-HF	ZQ	15.20	16	16.80	5	40	5	170	1	0.1	12
CZRQR52C18-HF	ZR	17.10	18	18.90	5	50	5	170	1	0.1	14
CZRQR52C20-HF	ZS	19.00	20	21.00	5	50	5	220	1	0.1	15
CZRQR52C22-HF	ZT	20.90	22	23.10	5	55	5	220	1	0.1	17
CZRQR52C24-HF	ZU	22.80	24	25.20	5	80	5	220	1	0.1	18
CZRQR52C27-HF	ZV	25.65	27	28.35	5	80	5	250	1	0.1	20
CZRQR52C30-HF	ZW	28.50	30	31.50	5	80	5	250	1	0.1	23
CZRQR52C33-HF	ZX	31.35	33	34.65	5	80	5	250	1	0.1	25
CZRQR52C36-HF	ZY	34.20	36	37.80	5	90	5	250	1	0.1	27
CZRQR52C39-HF	ZZ	37.05	39	40.95	5	90	5	300	1	0.1	29

RATING AND CHARACTERISTIC CURVES (CZRQR52C2-HF Thru CZRQR52C39-HF)

Fig.1 TEMPERATURE COEFFICIENTS

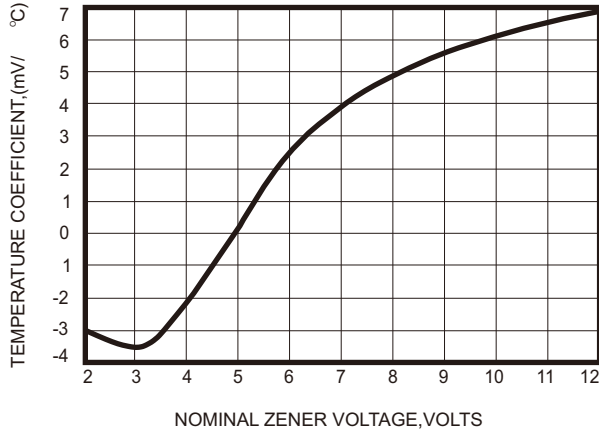

Fig.2 TEMPERATURE COEFFICIENTS

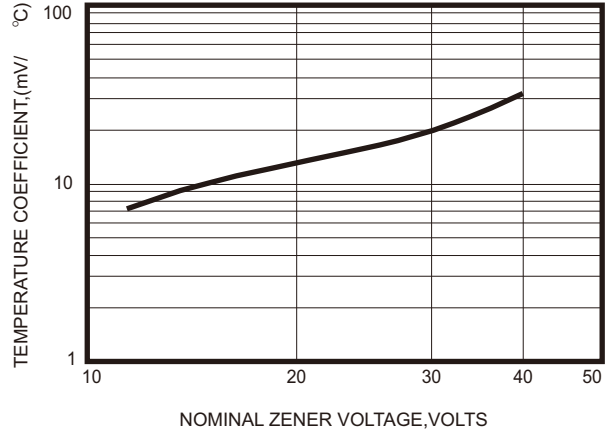

Fig.3 EFFECT OF ZENER VOLTAGE ON ZENER IMPEDANCE

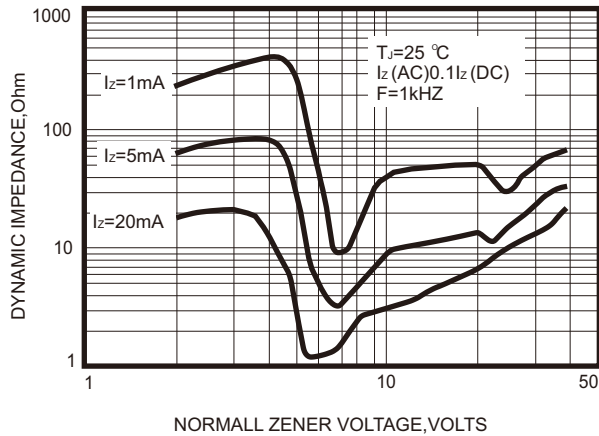

Fig.4 TYPICAL FORWARD VOLTAGE

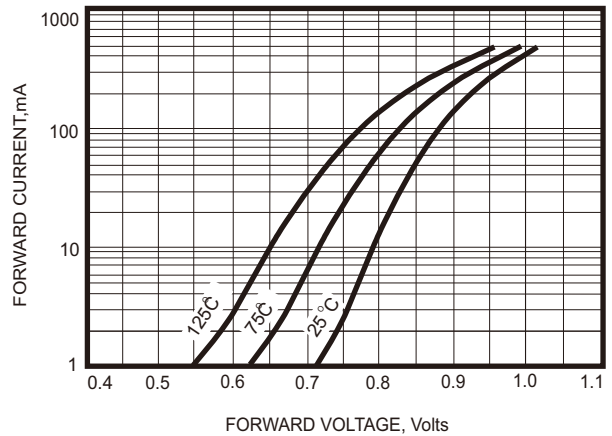

Fig.5 TYPICAL LEAKAGE CURRENT

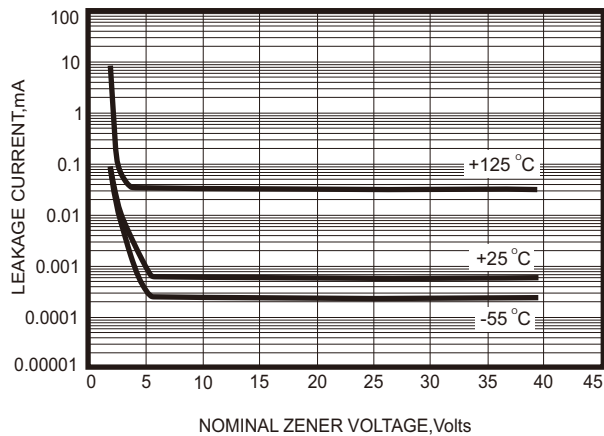
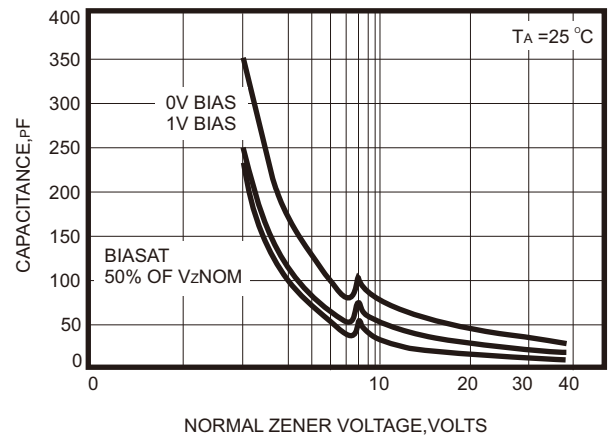

Fig.6 TYPICAL CAPACITANCE



RATING AND CHARACTERISTIC CURVES (CZRQR52C2-HF Thru CZRQR52C39-HF)

Fig.7 ZENER VOLTAGE VERSUS ZENER CURRENT

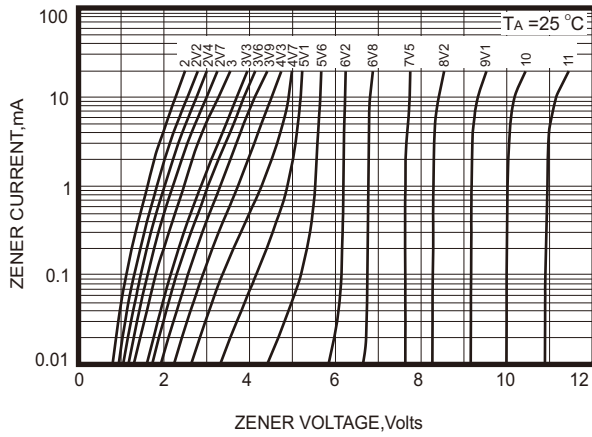

Fig.8 ZENER VOLTAGE VERSUS ZENER CURRENT

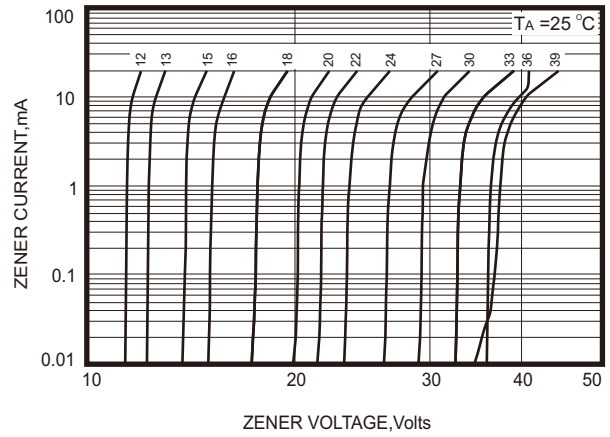
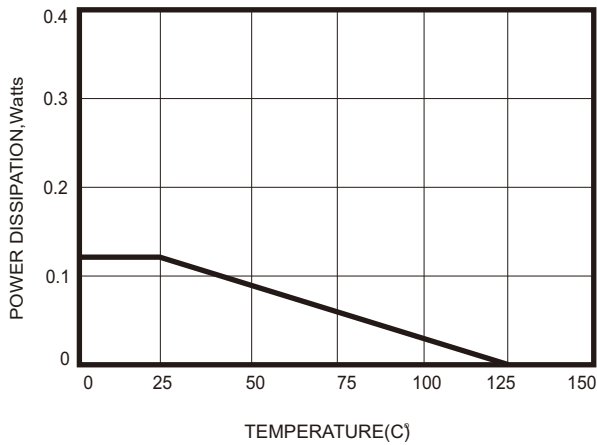
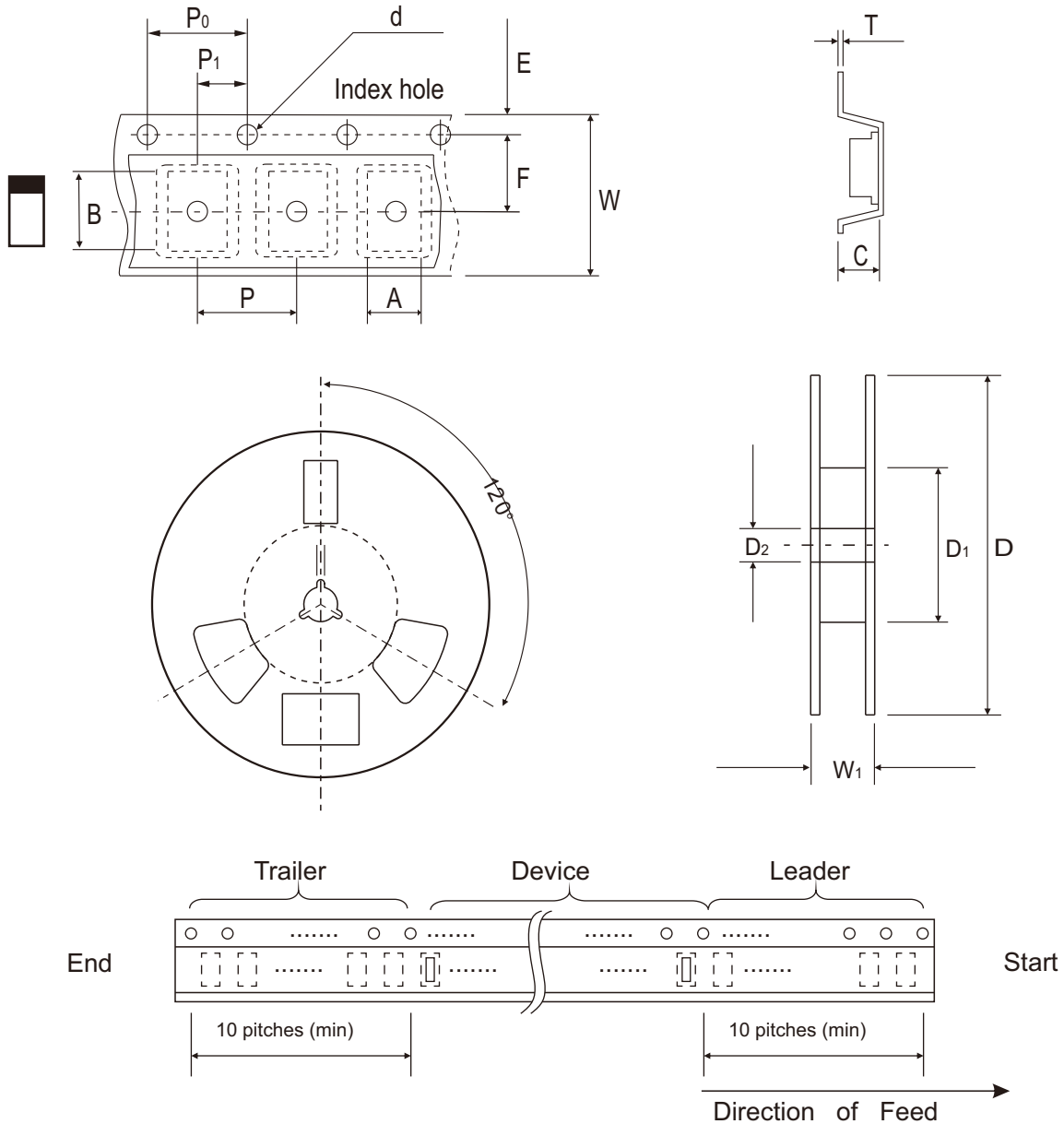

Fig.9 STEADY STATE POWER DERATING



Reel Taping Specification



0402 (SOD-923F)	SYMBOL	A	B	C	d	D	D ₁	D ₂
	(mm)	0.75 ± 0.05	1.17 ± 0.05	0.65 ± 0.05	1.50 + 0.10 - 0	178 ± 1	60.0 + 0.50 - 0	13.0 ± 0.20
	(inch)	0.030 ± 0.002	0.046 ± 0.002	0.026 ± 0.002	0.059 + 0.004 - 0	7.008 ± 0.039	2.362 + 0.020 - 0	0.512 ± 0.008

0402 (SOD-923F)	SYMBOL	E	F	P	P ₀	P ₁	T	W	W ₁
	(mm)	1.75 ± 0.10	3.50 ± 0.10	4.00 ± 0.10	4.00 ± 0.10	2.00 ± 0.10	0.20 + 0.02 - 0.05	8.00 ± 0.20	12.0 ± 0.15
	(inch)	0.069 ± 0.004	0.138 ± 0.004	0.157 ± 0.004	0.157 ± 0.004	0.079 ± 0.004	0.008 + 0.001 - 0.002	0.315 ± 0.008	0.472 ± 0.006

Suggested PAD Layout

SIZE	0402/SOD-923F	
	(mm)	(inch)
A	0.750	0.030
B	0.500	0.020
C	0.700	0.028
D	1.250	0.049
E	0.250	0.010

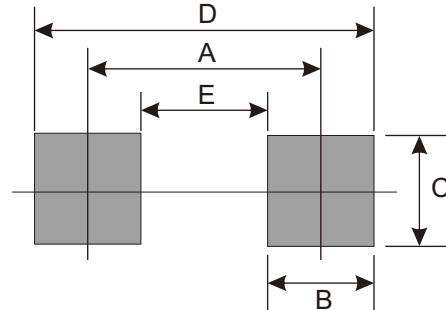

Standard Packaging

Case Type	Qty Per Reel	Reel Size
	(Pcs)	(inch)
0402/SOD-923F	5,000	7

X-ON Electronics

Largest Supplier of Electrical and Electronic Components

Click to view similar products for [Zener Diodes](#) category:

Click to view products by [Comchip](#) manufacturer:

Other Similar products are found below :

[RKZ13B2KG#P1](#) [DL5234B](#) [1N4682](#) [1N4693](#) [1N4732A](#) [1N4736A](#) [1N4750A](#) [1N4759ARL](#) [1N5241B](#) [1N5365B](#) [1N5369B](#) [1N747A](#)
[1N964B](#) [1N966B](#) [1N968B](#) [1N972B](#) [JANS1N4974US](#) [1N4692](#) [1N4702](#) [1N4704](#) [1N4711](#) [1N4714](#) [1N4745ARL](#) [1N4752ARL](#) [1N4760ARL](#)
[1N5221B](#) [1N5242BTR](#) [1N5350B](#) [1N5352B](#) [1N961BRR1](#) [1N964BRL](#) [RKZ5.1BKU#P6](#) [3SMAJ5946B-TP](#) [3SMAJ5950B-TP](#)
[MMSZ5230BQ-13-F](#) [MMSZ5232BQ-13-F](#) [BZX84C7V5](#) [3SMAJ5945B-TP](#) [3SMAJ5947B-TP](#) [3SMBJ5941B-TP](#) [DZ2S240M0L](#) [SMAZ27-](#)
[TP](#) [ZMM5224B-7](#) [RD16UM-T1-A](#) [RD39S-T1-A](#) [RD10S-T1-A](#) [CDZT2R5.6B](#) [1N4762A G](#) [Z1SMA18](#) [JANTX1N4553B](#)