

DTCxxxxUA-HF Series

RoHS Device
Halogen Free

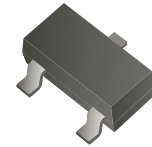

Features

- Epitaxial planar die construction.
- Built-in biasing resistors, $R_1 \neq R_2$.

Mechanical data

- Case: SOT-323, molded plastic.

Circuit Diagram

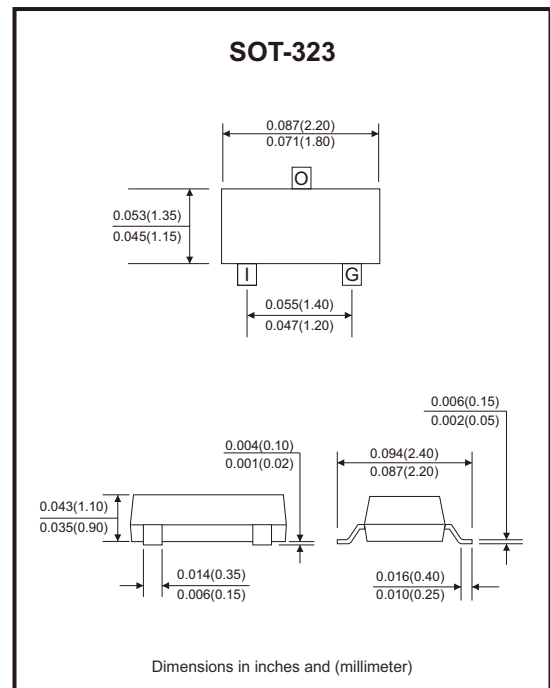
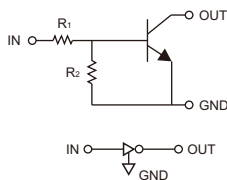

Maximum Ratings (at $T_a=25^\circ\text{C}$ unless otherwise noted)

Parameter	Symbol	Value	Units
Supply voltage	V_{CC}	50	V
Input voltage	V_{IN}	-5 to +10 -10 to +30 -6 to +40 -5 to +12 -5 to +12 -7 to +20 -5 to +30	V
Output current	I_o	100 100 70 100 100 100 100	mA
Output current	I_c (Max.)	100	mA
Power dissipation	P_d	200	mW
Thermal resistance, junction to ambient air	$R_{\theta JA}$	625	$^\circ\text{C/W}$
Operating and storage and temperature range	T_j, T_{STG}	-55 to +150	$^\circ\text{C}$

Electrical Characteristics (at Ta=25°C unless otherwise noted)

Parameter	Symbol	Test conditions	Min	Typ	Max	Units
Input voltage	V _{I(off)}	V _{CC} = 5V, I _O = 100μA	0.3			V
			0.8			
			0.3			
			0.5			
			0.3			
			0.3			
			0.5			
Input voltage	V _{I(on)}	V _O = 0.3V, I _O = 20mA V _O = 0.3V, I _O = 2mA V _O = 0.3V, I _O = 1mA V _O = 0.3V, I _O = 5mA V _O = 0.3V, I _O = 20mA V _O = 0.3V, I _O = 20mA V _O = 0.3V, I _O = 5mA			3.0	V
					3.0	
					1.4	
					1.1	
					3.0	
					2.5	
					1.3	
Output voltage	V _{O(on)}	I _O / I _I = 5mA / 0.25mA I _O / I _I = 10mA / 0.5mA		0.1	0.3	V
Input current	I _I	V _I = 5V			7.2	mA
					0.88	
					0.88	
					3.6	
					3.8	
					1.8	
					1.8	
Output current	I _{O(off)}	V _{CC} = 50V, V _I = 0V			0.5	μA
DC current gain	G _I	V _O = 5V, I _O = 10mA	33			
			24			
			68			
			80			
			33			
			30			
			80			
Input resistor	R ₁ (R ₂)			1(10)		kΩ
				10(4.7)		
				10(47)		
				2.2(47)		
				2.2(10)		
				4.7(10)		
				4.7(47)		
Input resistor (R ₁) tolerance	ΔR ₁		-30		+30	%
Resistance ratio tolerance	ΔR ₂ /R ₁		-20		+20	%
Gain-bandwidth product	f _r	V _{CE} = 10V, I _E = 5mA, f = 100MHz		250		MHz

Rating and Characteristic Curves (DTCxxxxUA-HF Series)

Fig.1 - Derating Curve

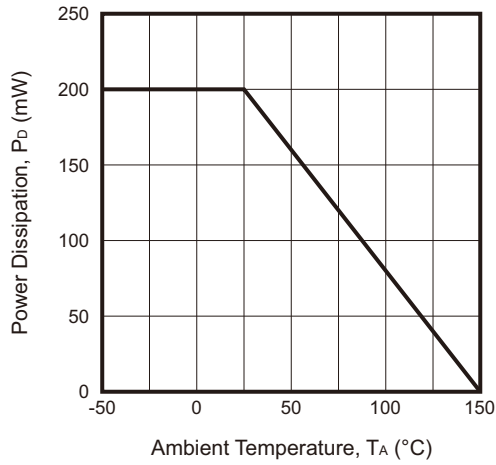

Fig.2 - $V_{CE(SAT)}$ vs. I_C

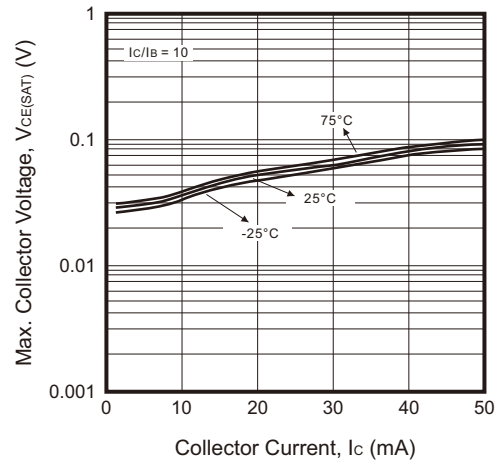

Fig.3 - DC Current Gain

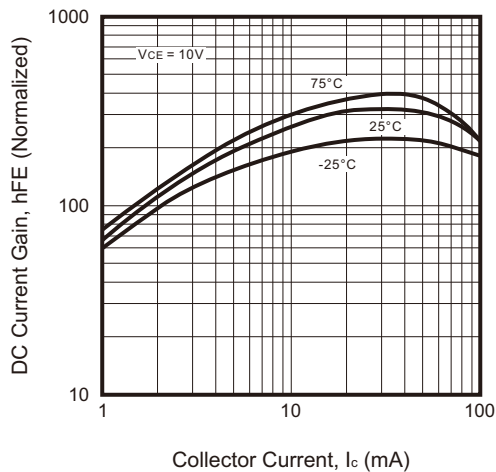

Fig.4 - Output Capacitance

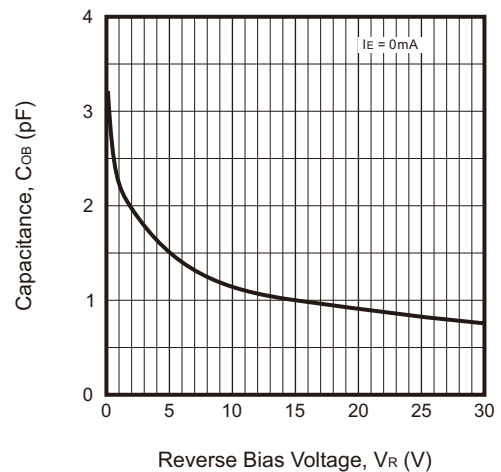

Fig.5 - Collector Current vs. Input Voltage

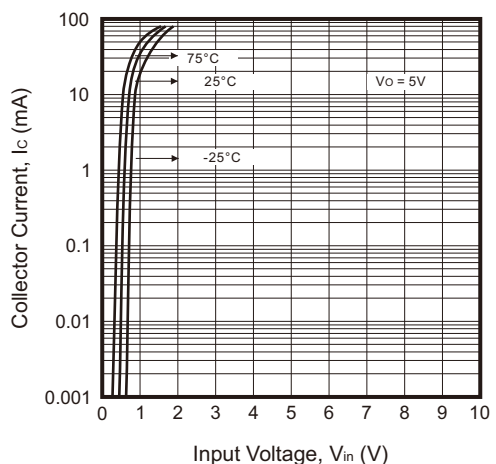
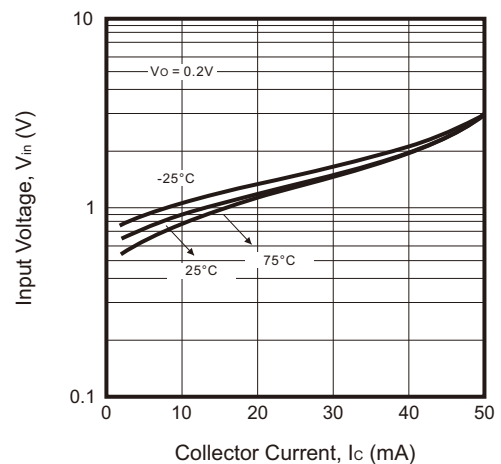

Fig.6 - Input Voltage vs. Collector Current



Company reserves the right to improve product design, functions and reliability without notice.

REV:A

Reel Taping Specification

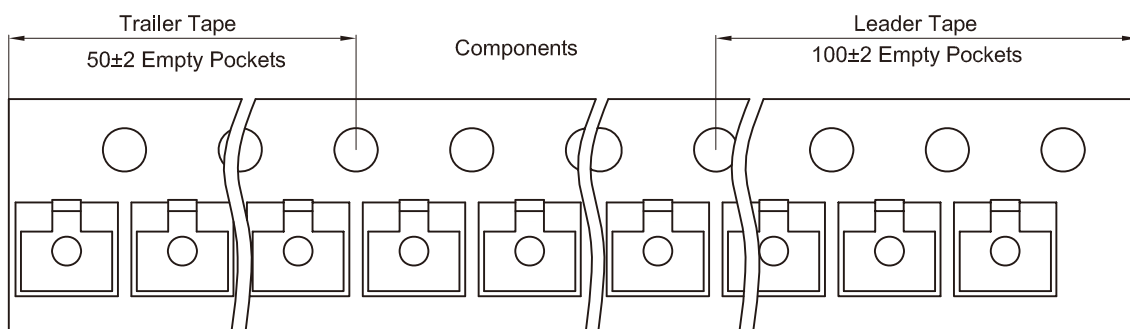
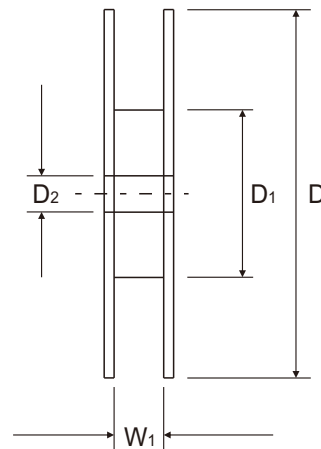
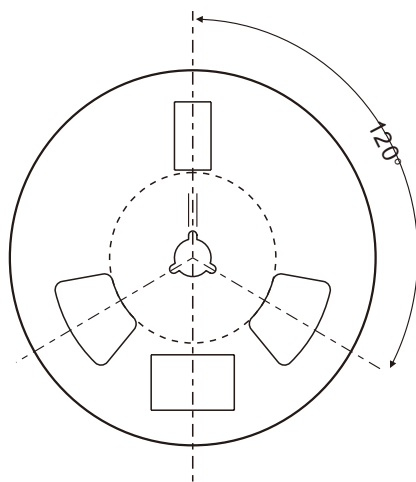
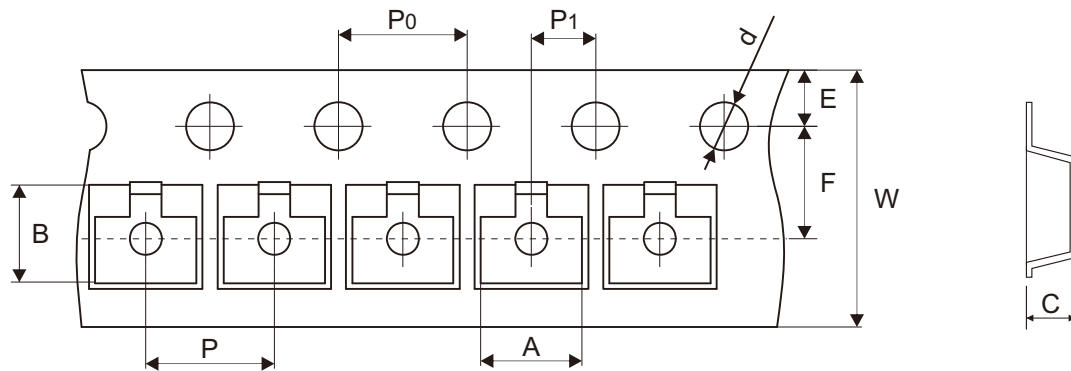

SOT-323	SYMBOL	A	B	C	d	D	D1	D2
	(mm)	2.25 ± 0.10	2.55 ± 0.10	1.20 ± 0.10	1.50 ± 0.10	178.00 ± 1.00	54.00 ± 0.50	13.00 ± 0.50
	(inch)	0.089 ± 0.004	0.100 ± 0.004	0.047 ± 0.004	0.059 ± 0.004	7.008 ± 0.039	2.126 ± 0.020	0.512 ± 0.020

SOT-323	SYMBOL	E	F	P	P0	P1	W	W1
	(mm)	1.75 ± 0.10	3.50 ± 0.05	4.00 ± 0.10	4.00 ± 0.10	2.00 ± 0.05	8.00 + 0.30 - 0.10	9.50 ± 1.00
	(inch)	0.069 ± 0.004	0.138 ± 0.002	0.157 ± 0.004	0.157 ± 0.004	0.079 ± 0.002	0.315 + 0.012 - 0.004	0.374 ± 0.039

Company reserves the right to improve product design, functions and reliability without notice.

REV:A

Marking Code

Part Number	Marking Code
DTC113ZUA-HF	E21
DTC114WUA-HF	84
DTC114YUA-HF	64
DTC123JUA-HF	E42
DTC123YUA-HF	62
DTC143XUA-HF	43•
DTC143ZUA-HF	E23

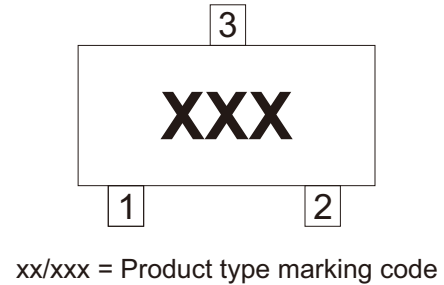

Suggested PAD Layout

SIZE	SOT-323	
	(mm)	(inch)
A	0.90	0.035
B	0.70	0.028
C	1.30	0.051
D	1.90	0.075

Note: 1. The pad layout is for reference purposes only.

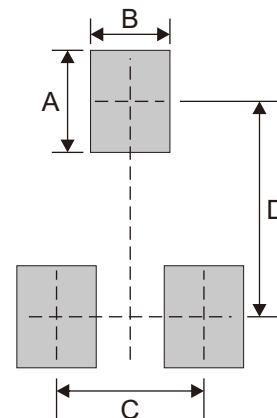

Standard Packaging

Case Type	REEL PACK	
	REEL (pcs)	Reel Size (inch)
SOT-323	3,000	7

X-ON Electronics

Largest Supplier of Electrical and Electronic Components

Click to view similar products for [Bipolar Transistors - Pre-Biased](#) category:

Click to view products by [Comchip](#) manufacturer:

Other Similar products are found below :

[RN1607\(TE85L,F\)](#) [DTA124GKAT146](#) [DTA144WETL](#) [DTA144WKAT146](#) [DTC113EET1G](#) [DTC115TETL](#) [DTC115TKAT146](#)
[DTC124TETL](#) [DTC144ECA-TP](#) [DTC144VUAT106](#) [MUN5241T1G](#) [BCR158WH6327XTSA1](#) [NSBA114TDP6T5G](#) [NSBA143ZF3T5G](#)
[NSBC114YF3T5G](#) [NSBC123TF3T5G](#) [SMUN5235T1G](#) [SMUN5330DW1T1G](#) [SSVMUN5312DW1T2G](#) [RN1303\(TE85L,F\)](#)
[RN4605\(TE85L,F\)](#) [TTEPROTOTYPE79](#) [DDTC114EUAQ-7-F](#) [EMH15T2R](#) [SMUN2214T3G](#) [SMUN5335DW1T1G](#) [NSBC114TF3T5G](#)
[NSBC143ZPDP6T5G](#) [NSVMUN5113DW1T3G](#) [SMUN5230DW1T1G](#) [SMUN5133T1G](#) [SMUN2214T1G](#) [DTC114EUA-TP](#)
[NSBA144EF3T5G](#) [NSVDTA114EET1G](#) [2SC2223-T1B-A](#) [2SC3912-TB-E](#) [SMUN5237DW1T1G](#) [SMUN5213DW1T1G](#)
[SMUN5114DW1T1G](#) [SMUN2111T1G](#) [NSVDTC144EM3T5G](#) [DTC124ECA-TP](#) [DTC123TM3T5G](#) [DTA114ECA-TP](#) [DTA113EM3T5G](#)
[DCX115EK-7-F](#) [DTC113EM3T5G](#) [NSVMUN5135DW1T1G](#) [NSVMUN2237T1G](#)