

## MMBT2222A-G (NPN)

RoHS Device

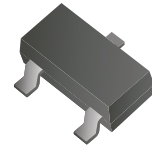

### Features

-NPN silicon epitaxial planar transistor for switching and amplifier application.

### Mechanical data

- Case: SOT-23, molded plastic.
- Terminals: solderable per MIL-STD-750, method 2026.
- Approx. weight: 0.008 grams

### Diagram:

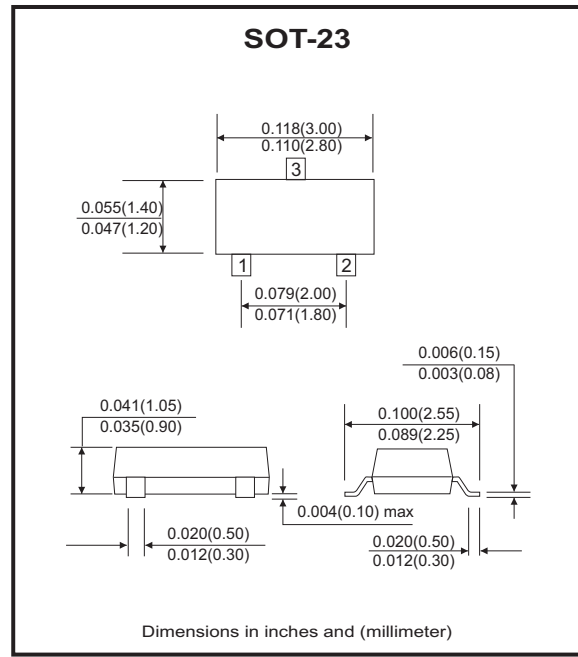
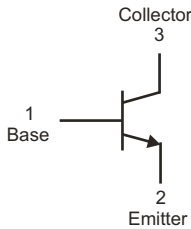

### Maximum Ratings (at Ta=25°C unless otherwise noted)

Parameter	Symbol	Value	Units
Collector-Base voltage	V <sub>CB0</sub>	75	V
Collector-Emitter voltage	V <sub>CEO</sub>	40	V
Emitter-Base voltage	V <sub>EBO</sub>	6.0	V
Collector current-continuous	I <sub>c</sub>	600	mA
Power dissipation	P <sub>c</sub>	300	mW
Thermal resistance, junction to ambient	R <sub>θJA</sub>	417	°C/W
Junction temperature	T <sub>J</sub>	150	°C
Storage temperature range	T <sub>STG</sub>	-55 to +150	°C

Company reserves the right to improve product design , functions and reliability without notice.

## Electrical Characteristics (@TA=25°C unless otherwise noted)

Parameter	Symbol	Conditions	Min.	Max.	Units
Collector-Base breakdown voltage	$V_{(BR)CBO}$	$I_C=10\mu A, I_E=0$	75		V
Collector-Emitter breakdown voltage	$V_{(BR)CEO}$	$I_C=10mA, I_B=0$	40		V
Emitter-Base breakdown voltage	$V_{(BR)EBO}$	$I_E=10\mu A, I_C=0$	6		V
Collector cut-off current	$I_{CBO}$	$V_{CB}=60V, I_E=0$		0.01	$\mu A$
Collector cut-off current	$I_{CEO}$	$V_{CE}=30V, V_{BE(off)}=3V$		0.01	$\mu A$
Emitter cut-off current	$I_{EBO}$	$V_{EB}=3V, I_C=0$		0.1	$\mu A$
DC current gain	$h_{FE(1)}$	$V_{CE}=10V, I_C=150mA$	100	300	
	$h_{FE(2)}$	$V_{CE}=10V, I_C=0.1mA$	40		
	$h_{FE(3)}$	$V_{CE}=10V, I_C=500mA$	42		
Collector-Emitter saturation voltage	$V_{CE(sat)}$	$I_C=150mA, I_B=15mA$ $I_C=500mA, I_B=50mA$		0.3 1	V
Base-Emitter saturation voltage	$V_{BE(sat)}$	$I_C=150mA, I_B=15mA$ $I_C=500mA, I_B=50mA$		1.2 2.0	V
Transition frequency	$f_T$	$V_{CE}=20V, I_C=20mA$ $f=100MHz$	300		MHz
Delay time (see fig.1)	$t_d$	$V_{CC}=30V, V_{BE(off)}=-0.5V$ $I_C=150mA, I_{B1}=15mA$		10	nS
Rise time (see fig.1)	$t_r$			25	nS
Storage time (see fig.2)	$t_s$			225	nS
Fall time (see fig.2)	$t_f$	$V_{CC}=30V, I_C=150mA$ $I_{B1}=-I_{B2}=15mA$		60	nS

Notes:

1. Pulse test: Pulse Width  $\leq 300\mu s$ , Duty Cycle  $\leq 2.0\%$ .

Company reserves the right to improve product design , functions and reliability without notice.

## RATING AND CHARACTERISTIC CURVES (MMBT2222A-G)

Fig.1 - Static Characteristic

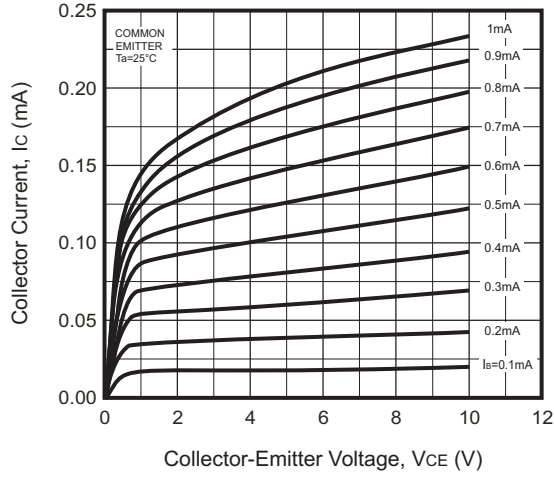

Fig.2 -  $h_{FE} - I_c$

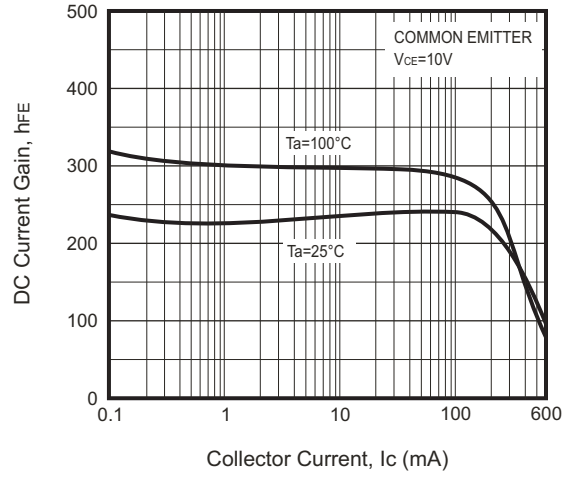

Fig.3 -  $V_{CEsat} - I_c$

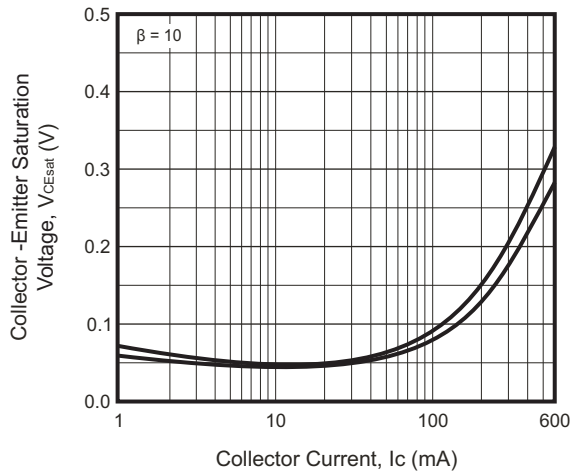

Fig.4 -  $V_{BEsat} - I_c$

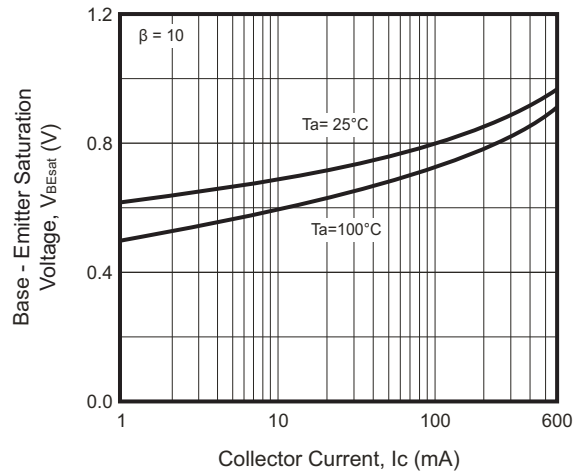

Fig.5 -  $I_c - V_{BE}$

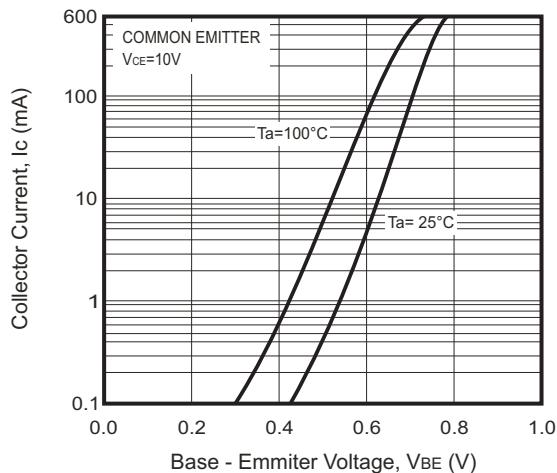
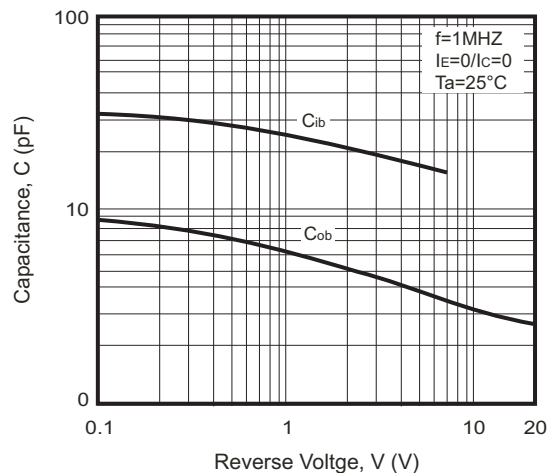

Fig.7 -  $C_{ob}/C_{ib} - V_{CB}/V_{EB}$



## RATING AND CHARACTERISTIC CURVES (MMBT2222A-G)

Fig.7 -  $F_T$  —  $I_c$

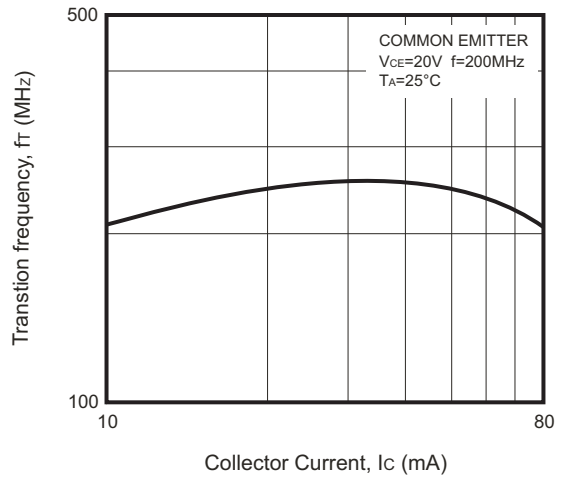
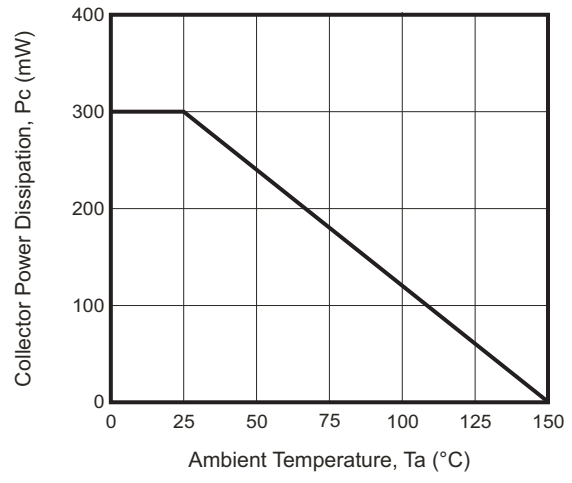
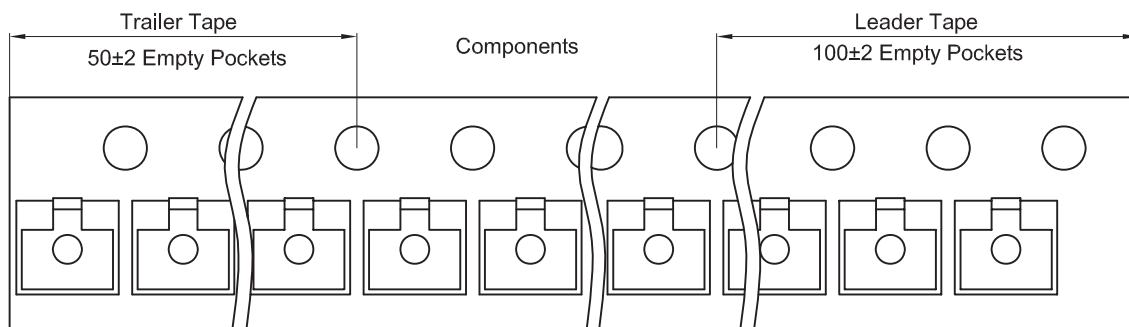
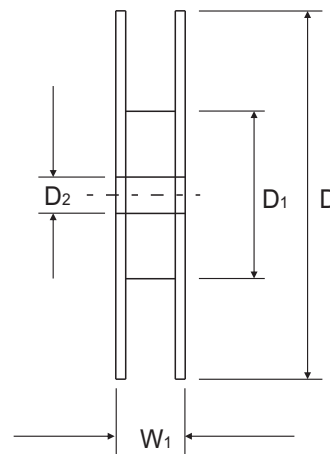
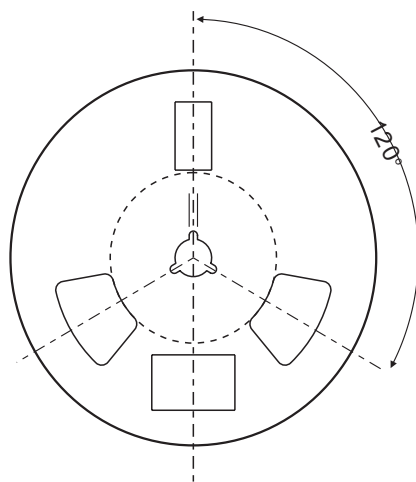
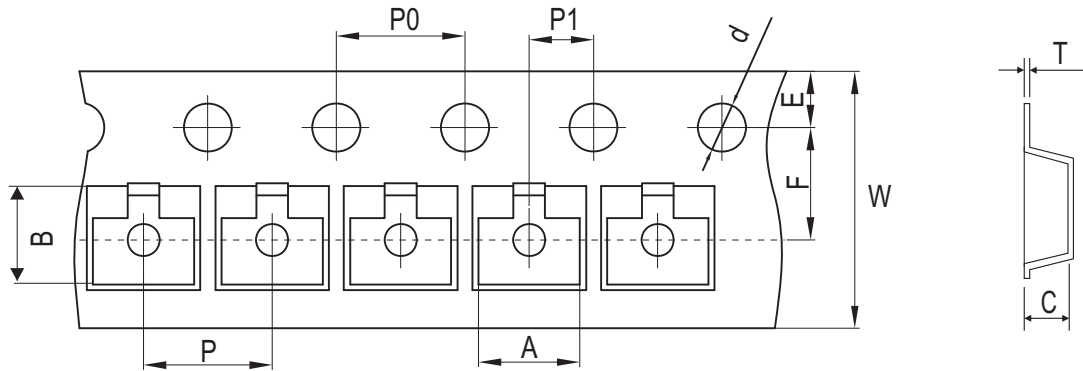

Fig.8 -  $P_c$  —  $T_a$



## Reel Taping Specification



SOT-23	SYMBOL	A	B	C	d	D	D1	D2
	(mm)	3.15 ± 0.10	2.77 ± 0.10	1.22 ± 0.10	Φ1.50 ± 0.10	178 ± 2.00	54.40 ± 1.00	13.00 ± 1.00
	(inch)	0.124 ± 0.004	0.109 ± 0.004	0.048 ± 0.004	Φ0.059 ± 0.004	7.008 ± 0.079	2.142 ± 0.039	0.512 ± 0.039

SOT-23	SYMBOL	E	F	P	P0	P1	W	W1
	(mm)	1.75 ± 0.10	3.50 ± 0.10	4.00 ± 0.10	4.00 ± 0.10	2.00 ± 0.10	8.00 + 0.30 / - 0.10	12.30 ± 1.00
	(inch)	0.069 ± 0.004	0.138 ± 0.004	0.157 ± 0.004	0.157 ± 0.004	0.079 ± 0.004	0.315 + 0.012 / - 0.004	0.484 ± 0.039

## Marking Code

Part Number	Marking Code
MMBT2222A-G	1P

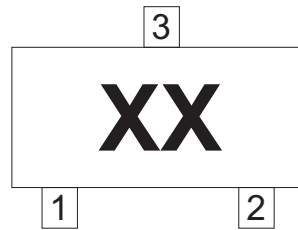

xx = Product type marking code

## Suggested PAD Layout

SIZE	SOT-23	
	(mm)	(inch)
A	0.80	0.031
B	1.90	0.075
C	2.02	0.080
D	2.82	0.111

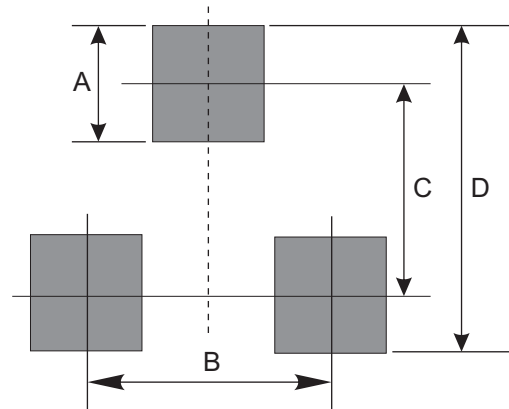

## Standard Packaging

Case Type	REEL PACK	
	REEL ( pcs )	Reel Size (inch)
SOT-23	3,000	7

## X-ON Electronics

Largest Supplier of Electrical and Electronic Components

*Click to view similar products for [RF Bipolar Transistors](#) category:*

*Click to view products by [Comchip](#) manufacturer:*

Other Similar products are found below :

[MAPRST0912-50](#) [MCH4016-TL-H](#) [MMBT5551-G](#) [MRF10120](#) [15GN01CA-TB-E](#) [PH1214-25M](#) [MAPRST0912-350](#) [MMBTH10-TP](#) [BFP640F H6327](#) [BFP 720F H6327](#) [BFP 740F H6327](#) [BFR 360F H6765](#) [MRF10031](#) [NSVF4009SG4T1G](#) [BFP 182R E7764](#)  
[BFP405H6740XTSA1](#) [MRF10350](#) [BFR360FH6765XTSA1](#) [BFP410H6327XTSA1](#) [BFP620FH7764XTSA1](#) [BFP720ESDH6327XTSA1](#)  
[BFP720FH6327XTSA1](#) [BFR360L3E6765XTMA1](#) [BFP420H6433XTMA1](#) [BFP420H6740XTSA1](#) [BFP420H6801XTSA1](#) [MCH4015-TL-H](#)  
[BF888H6327XTSA1](#) [MMBT2222A-G](#) [BFP196WH6327XTSA1](#) [BFP405FH6327XTSA1](#) [BFP640ESDH6327XTSA1](#)  
[BFR193L3E6327XTMA1](#) [BFS483H6327XTSA1](#) [NSVF4020SG4T1G](#) [NSVF6003SB6T1G](#) [MRF10005](#) [BFP420FH6327XTSA1](#)  
[BFP740FESDH6327XTSA1](#) [BFR181E6327HTSA1](#) [BFR181WH6327XTSA1](#) [BFR182E6327HTSA1](#) [BFR193E6327HTSA1](#)  
[BFP181E7764HTSA1](#) [BFP183WH6327XTSA1](#) [BFP720H6327XTSA1](#) [BFR182WH6327XTSA1](#) [BFU590GX](#) [MAPR-000912-500S00](#)  
[BFR340FH6327XTSA1](#)