

MMBT5551-G (NPN) RoHS Device

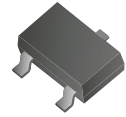

Features

- Epitaxial planar die construction.
- Complementary PNP type available (MMBT5401-G).
- Ideal for medium power amplification and switching.

Mechanical data

- Case: SOT-23, molded plastic.
- Terminals: Solderable per MIL-STD-750, method 2026.
- Approx. weight: 0.008 grams(approx.).

Circuit Diagram:

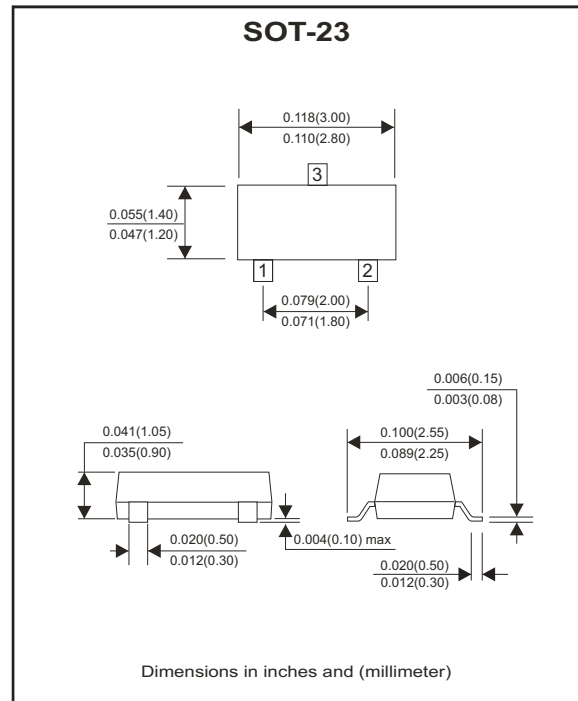
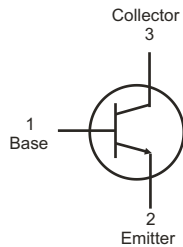

Maximum Ratings (at TA=25°C unless otherwise noted)

Parameter	Symbol	Value	Unit
Collector-base voltage	V_{CBO}	180	V
Collector-emitter voltage	V_{CEO}	160	V
Emitter-base voltage	V_{EBO}	6	V
Collector current	I_C	600	mA
Collector power dissipation	P_C	300	mW
Thermal resistance from junction to ambient	$R_{\theta JA}$	416	°C/W
Junction temperature range	T_J	150	°C
Storage temperature range	T_{STG}	-55 ~ +150	°C

Electrical Characteristics (at $T_A=25^\circ\text{C}$ unless otherwise noted)

Parameter	Conditions	Symbol	Min.	Typ.	Max.	Unit
Collector-base breakdown voltage	$I_C=100\mu\text{A}$, $I_E=0$	$V_{(BR)CBO}$	180			V
Collector-emitter breakdown voltage	$I_C=1\text{mA}$, $I_B=0$	$V_{(BR)CEO}^*$	160			V
Emitter-base breakdown voltage	$I_E=10\mu\text{A}$, $I_C=0$	$V_{(BR)EBO}$	6			V
Collector cut-off current	$V_{CB}=120\text{V}$, $I_E=0$	I_{CBO}			50	nA
Emitter cut-off current	$V_{EB}=4\text{V}$, $I_C=0$	I_{EBO}			50	nA
DC current gain	$V_{CE}=5\text{V}$, $I_C=1\text{mA}$	$h_{FE(1)}^*$	80			
	$V_{CE}=5\text{V}$, $I_C=10\text{mA}$	$h_{FE(2)}^*$	100		200	
	$V_{CE}=5\text{V}$, $I_C=50\text{mA}$	$h_{FE(3)}^*$	50			
Collector-emitter saturation voltage	$I_C=10\text{mA}$, $I_B=1\text{mA}$	$V_{CE(sat)1}^*$			0.15	V
	$I_C=50\text{mA}$, $I_B=5\text{mA}$	$V_{CE(sat)2}^*$			0.20	V
Base-emitter saturation voltage	$I_C=10\text{mA}$, $I_B=1\text{mA}$	$V_{BE(sat)1}^*$			1	V
	$I_C=50\text{mA}$, $I_B=5\text{mA}$	$V_{BE(sat)2}^*$			1	V
Transition frequency	$V_{CE}=10\text{V}$, $I_C=10\text{mA}$, $f=100\text{MHz}$	f_r	100		300	MHz
Collector output capacitance	$V_{CB}=10\text{V}$, $I_E=0$, $f=1\text{MHz}$	C_{ob}			6	pF

*Pulse test: pulse width $\leq 300\mu\text{s}$, duty cycle $\leq 2.0\%$

RATING AND CHARACTERISTIC CURVES (MMBT5551-G)

Fig.1 - Static Characteristic

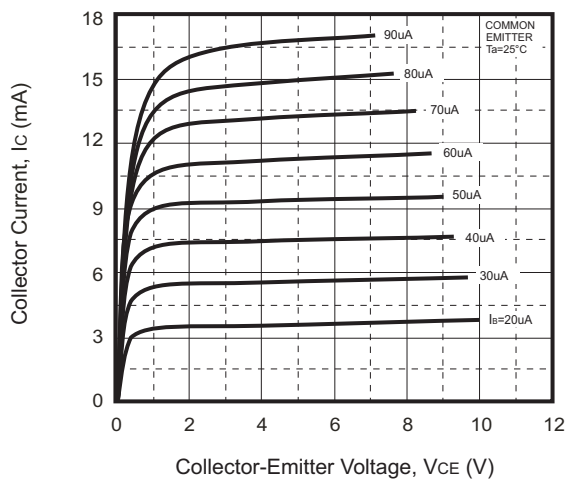
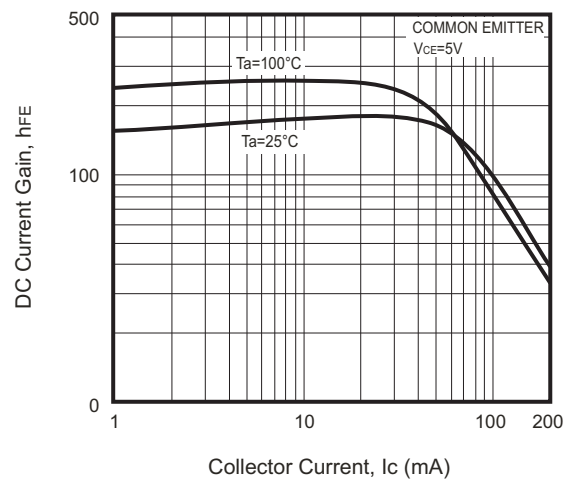

Fig.2 - $h_{FE} - I_C$



RATING AND CHARACTERISTIC CURVES (MMBT5551-G)

Fig.3 - $V_{BEsat} - I_c$

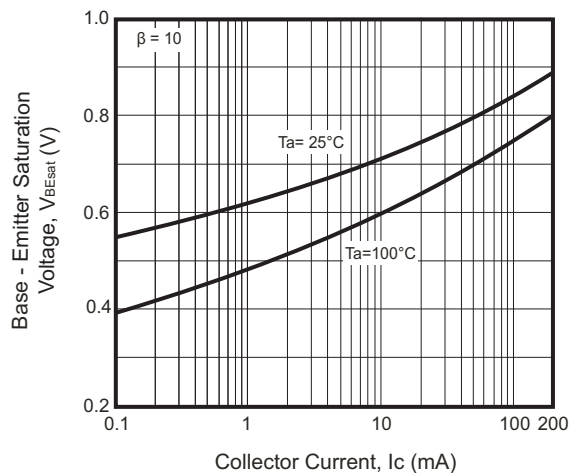

Fig.4 - $V_{CEsat} - I_c$

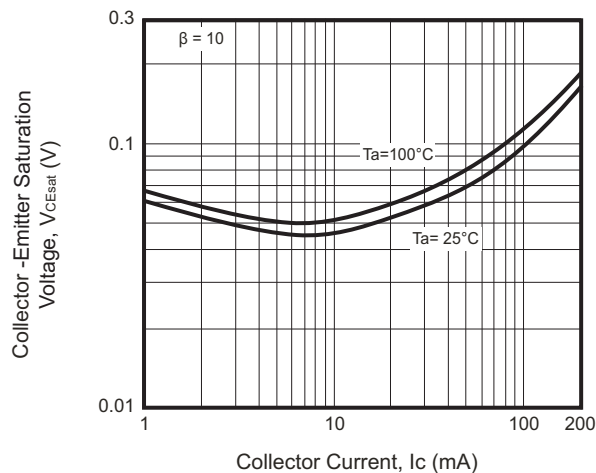

Fig.5 - $I_c - V_{BE}$

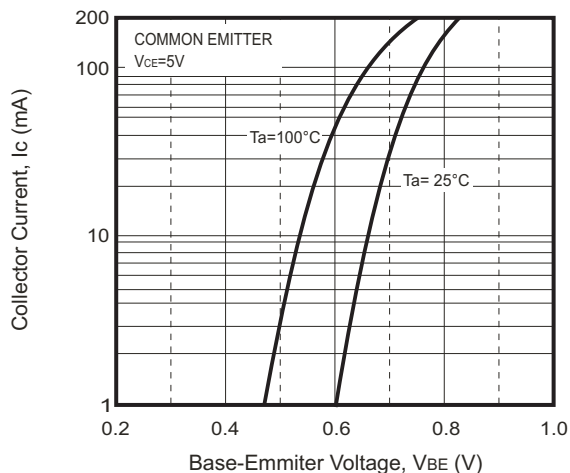

Fig.7 - $C_{ob}/C_{ib} - V_{CB}/V_{EB}$

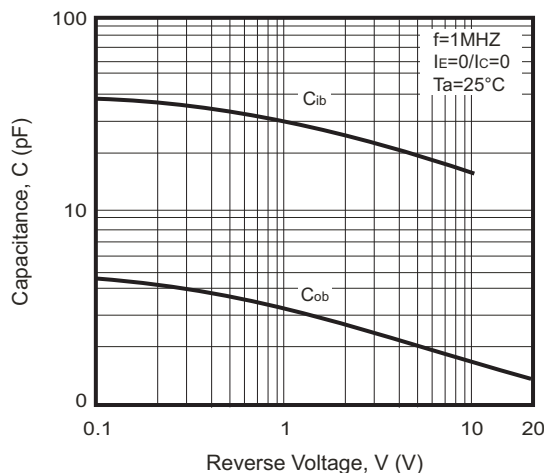

Fig.7 - $f_T - I_c$

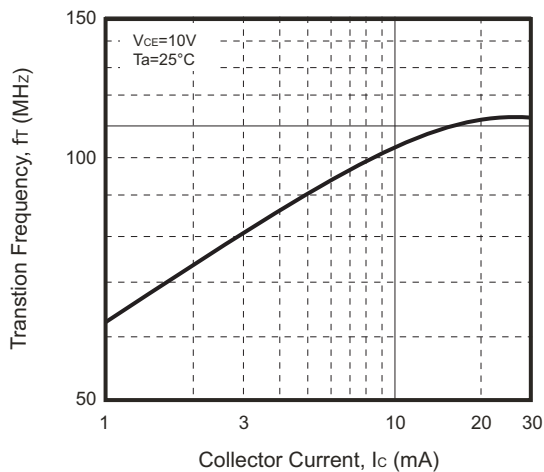
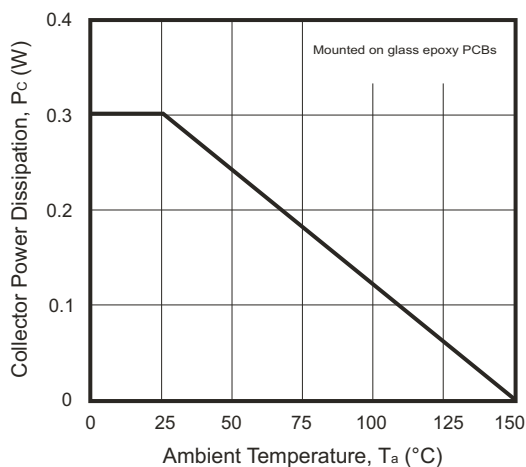
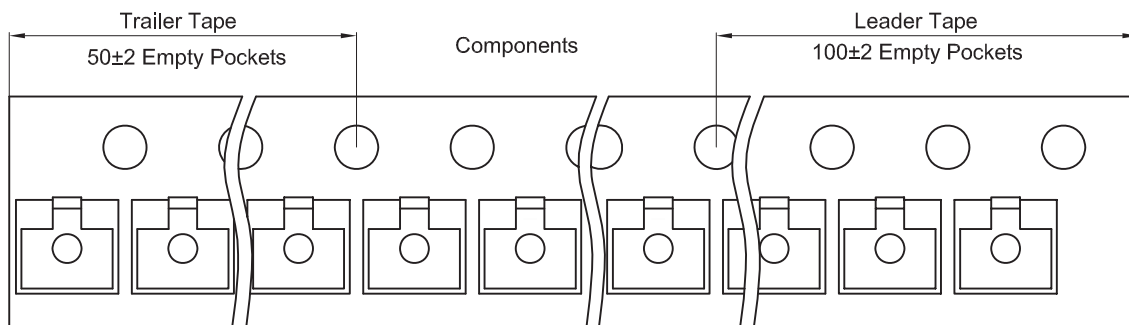
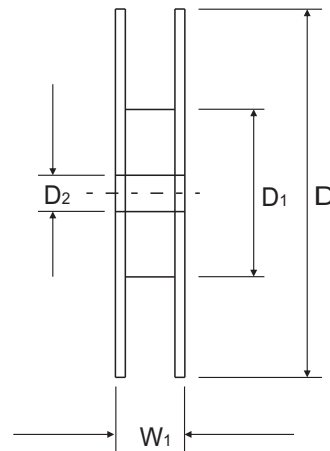
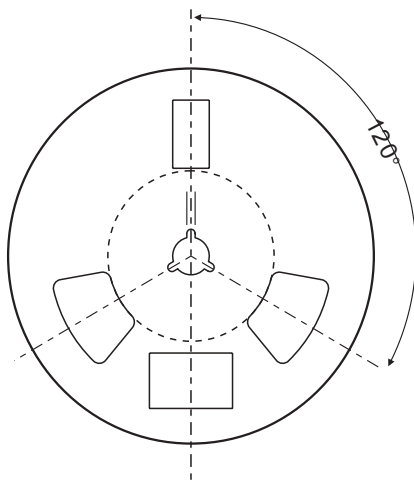
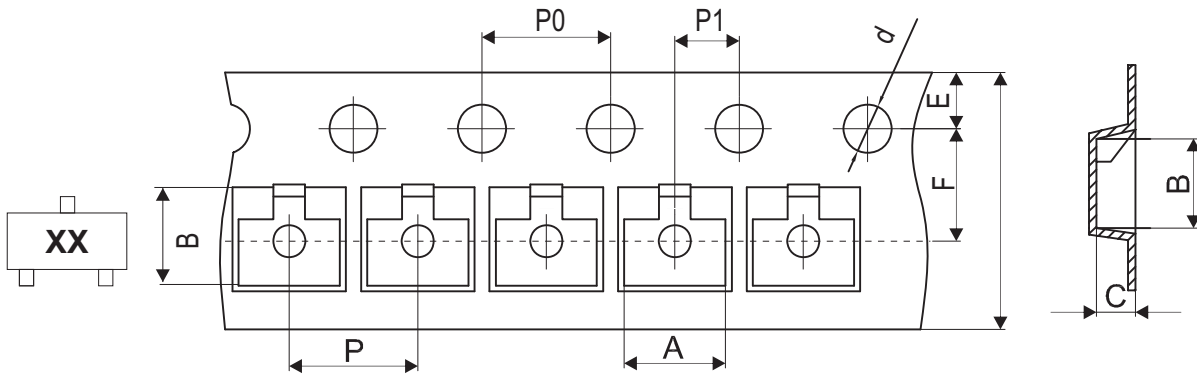

Fig.8 - $P_c - T_a$



Reel Taping Specification



SOT-23	SYMBOL	A	B	C	d	D	D1	D2
	(mm)	3.15 ± 0.10	2.77 ± 0.10	1.22 ± 0.10	1.50 ± 0.10	178.00 ± 2.00	54.40 ± 1.00	13.00 ± 1.00
	(inch)	0.124 ± 0.004	0.109 ± 0.004	0.048 ± 0.004	0.059 ± 0.004	7.008 ± 0.079	2.142 ± 0.039	0.512 ± 0.039

SOT-23	SYMBOL	E	F	P	P0	P1	W	W1
	(mm)	1.75 ± 0.10	3.50 ± 0.10	4.00 ± 0.10	4.00 ± 0.10	2.00 ± 0.10	8.00 + 0.30 / - 0.10	12.30 ± 1.00
	(inch)	0.069 ± 0.004	0.138 ± 0.004	0.157 ± 0.004	0.157 ± 0.004	0.079 ± 0.004	0.315 + 0.012 / - 0.004	0.484 ± 0.039

Marking Code

Part Number	Marking Code
MMBT5551-G	G1

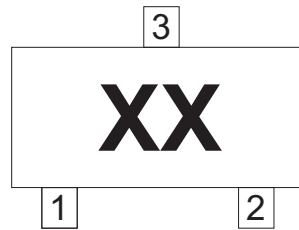

xx = Product type marking code

Suggested PAD Layout

SIZE	SOT-23	
	(mm)	(inch)
A	0.60	0.024
B	0.80	0.031
C	1.90	0.075
D	2.02	0.080
E	2.82	0.111

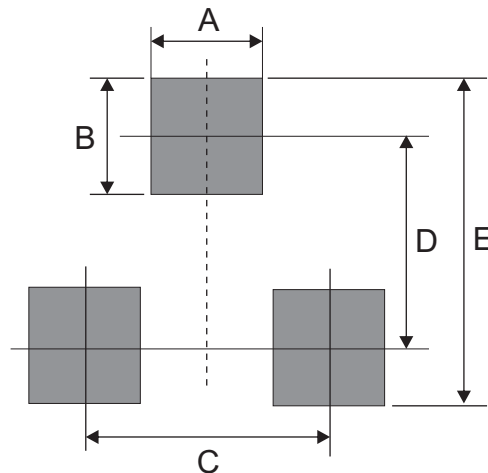

Standard Packaging

Case Type	Qty Per Reel	Reel Size
	(Pcs)	(inch)
SOT-23	3,000	7

X-ON Electronics

Largest Supplier of Electrical and Electronic Components

Click to view similar products for [RF Bipolar Transistors](#) category:

Click to view products by [Comchip](#) manufacturer:

Other Similar products are found below :

[MAPRST0912-50](#) [MCH4016-TL-H](#) [MMBT5551-G](#) [MRF10120](#) [15GN01CA-TB-E](#) [PH1214-25M](#) [MAPRST0912-350](#) [MMBTH10-TP](#) [BFP640F H6327](#) [BFP 720F H6327](#) [BFP 740F H6327](#) [BFR 360F H6765](#) [MRF10031](#) [NSVF4009SG4T1G](#) [BFP 182R E7764](#)
[BFP405H6740XTSA1](#) [MRF10350](#) [BFR360FH6765XTSA1](#) [BFP410H6327XTSA1](#) [BFP620FH7764XTSA1](#) [BFP720ESDH6327XTSA1](#)
[BFP720FH6327XTSA1](#) [BFR360L3E6765XTMA1](#) [BFP420H6433XTMA1](#) [BFP420H6740XTSA1](#) [BFP420H6801XTSA1](#) [MCH4015-TL-H](#)
[BF888H6327XTSA1](#) [MMBT2222A-G](#) [BFP196WH6327XTSA1](#) [BFP405FH6327XTSA1](#) [BFP640ESDH6327XTSA1](#)
[BFR193L3E6327XTMA1](#) [BFS483H6327XTSA1](#) [NSVF4020SG4T1G](#) [NSVF6003SB6T1G](#) [MRF10005](#) [BFP420FH6327XTSA1](#)
[BFP740FESDH6327XTSA1](#) [BFR181E6327HTSA1](#) [BFR181WH6327XTSA1](#) [BFR182E6327HTSA1](#) [BFR193E6327HTSA1](#)
[BFP181E7764HTSA1](#) [BFP183WH6327XTSA1](#) [BFP720H6327XTSA1](#) [BFR182WH6327XTSA1](#) [BFU590GX](#) [MAPR-000912-500S00](#)
[BFR340FH6327XTSA1](#)