

MMBTA06-HF (NPN)

RoHS Device
Halogen Free

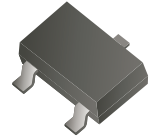

Features

- Power dissipation of 300mW.
- High stability and high reliability.
- For switching and amplifier applications.

Mechanical data

- Case: SOT-23, molded plastic.
- Epoxy : UL 94V-0.
- Mounting position: Any.

Circuit Diagram

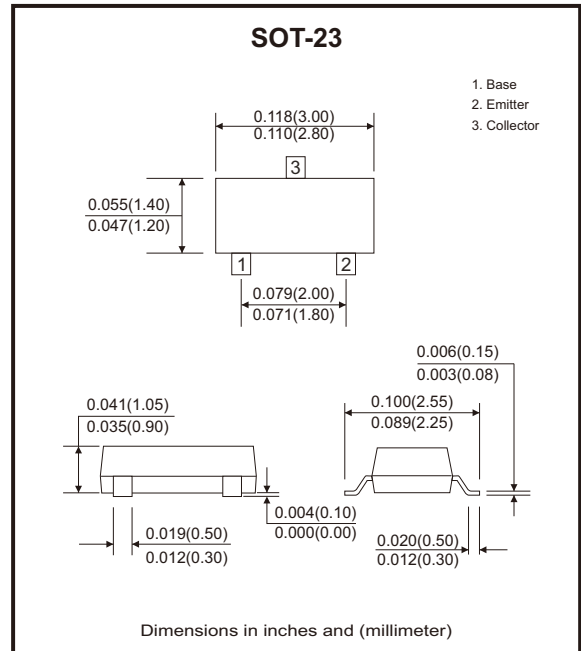
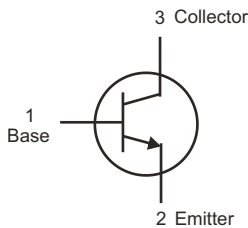

Maximum Ratings (at TA=25°C unless otherwise noted)

Parameter	Symbol	Value	Unit
Collector-base voltage	V _{CBO}	80	V
Collector-emitter voltage	V _{CEO}	80	V
Emitter-base voltage	V _{EBO}	4	V
Collector current-continuous	I _C	500	mA
Collector power dissipation	P _C	300	mW
Junction temperature	T _J	150	°C
Storage temperature range	T _{STG}	-55 to +150	°C
Thermal resistance, junction to ambient	R _{θJA}	416	°C/W

Electrical Characteristics (at $T_A=25^\circ\text{C}$ unless otherwise noted)

Parameter	Conditions	Symbol	Min	Max	Unit
Collector-base breakdown voltage	$I_C = 100\mu\text{A}, I_E = 0$	$V_{(BR)CBO}$	80		V
Collector-emitter breakdown voltage	$I_C = 1\text{mA}, I_B = 0$	$V_{(BR)CEO}$	80		V
Emitter-base breakdown voltage	$I_E = 100\mu\text{A}, I_C = 0$	$V_{(BR)EBO}$	4		V
Collector cut-off current	$V_{CB} = 80\text{V}, I_E = 0$	I_{CBO}		100	nA
Collector cut-off current	$V_{CE} = 60\text{V}, I_B = 0$	I_{CEO}		1.0	μA
Emitter cut-off current	$V_{EB} = 3\text{V}, I_C = 0$	I_{EBO}		100	nA
DC current gain (Note 1)	$V_{CE} = 1\text{V}, I_C = 10\text{mA}$	$h_{FE(1)}$	100	400	
	$V_{CE} = 1\text{V}, I_C = 100\text{mA}$	$h_{FE(2)}$	100		
Collector-emitter saturation voltage (Note 1)	$I_C = 100\text{mA}, I_B = 10\text{mA}$	$V_{CE(sat)}$		0.25	V
Base-emitter saturation voltage (Note 1)	$I_C = 100\text{mA}, I_B = 10\text{mA}$	$V_{BE(sat)}$		1.20	V
Transition frequency	$V_{CE} = 2\text{V}, I_C = 10\text{mA}, f = 100\text{MHz}$	f_T	100		MHz

Note: 1. Pulse width $\leq 300\mu\text{s}$, duty cycle $\leq 2.0\%$.

Rating and Characteristic Curves (MMBTA06-HF)

Fig.1 - Static Characteristic

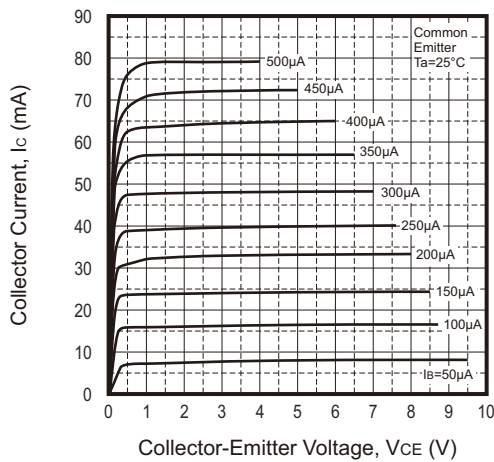

Fig.2 - $h_{FE} - I_C$

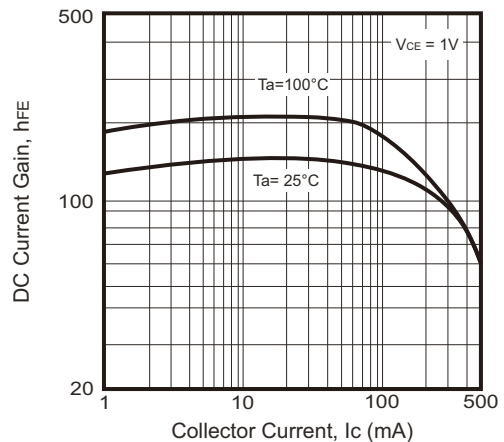

Fig.3 - $V_{CEsat} - I_C$

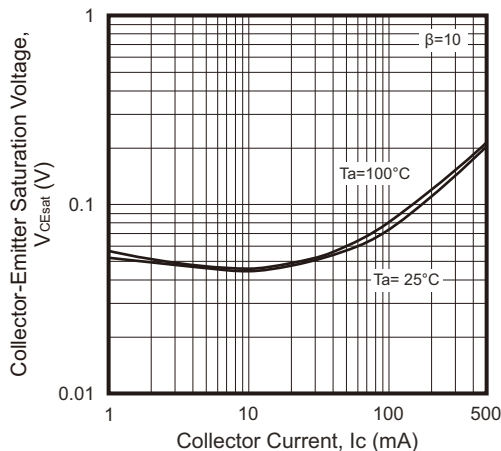
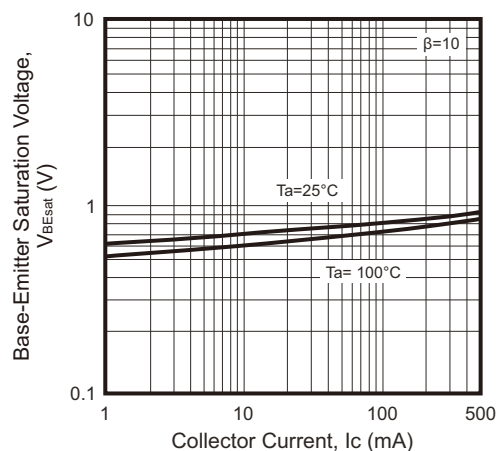

Fig.4 - $V_{BEsat} - I_C$



Company reserves the right to improve product design, functions and reliability without notice.

REV:A

Rating and Characteristic Curves (MMBTA06-HF)

Fig.5 - $V_{BE} - I_c$

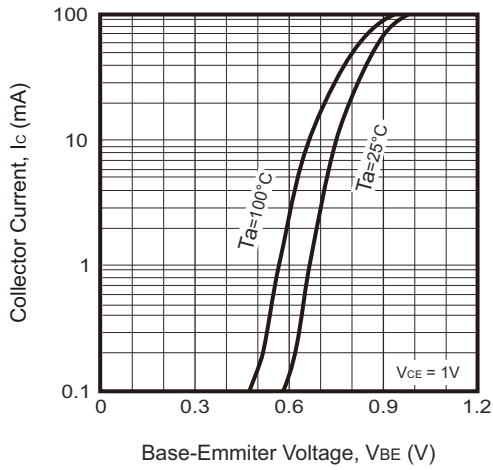

Fig.6 - $C_{ob}/C_{ib} - V_{ce}/V_{EB}$

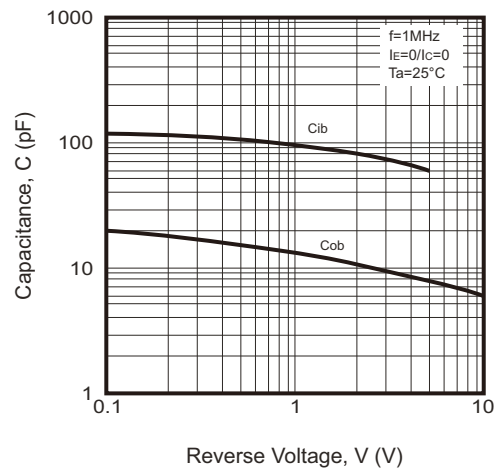

Fig.7 - $f_r - I_c$

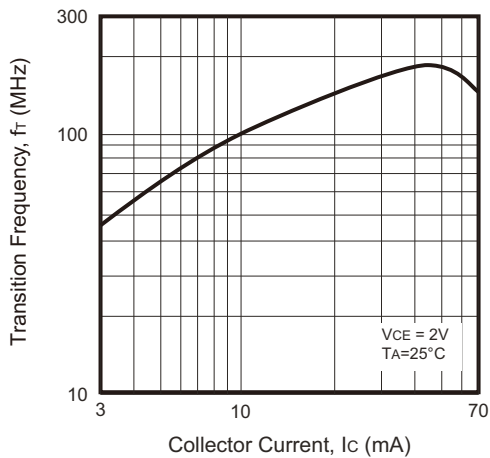
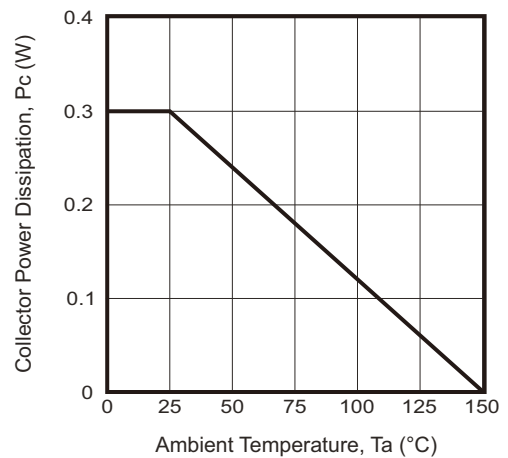
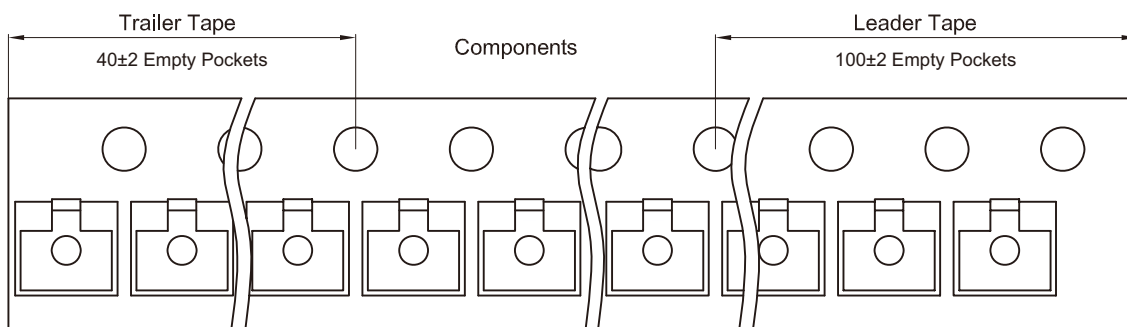
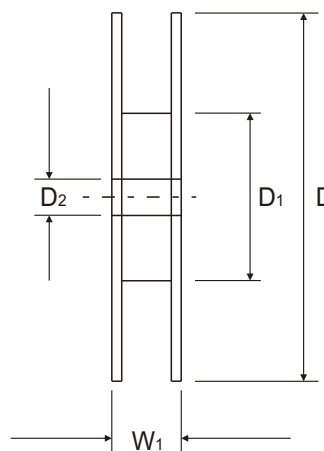
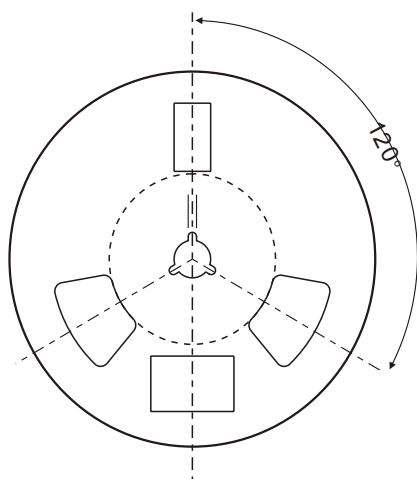
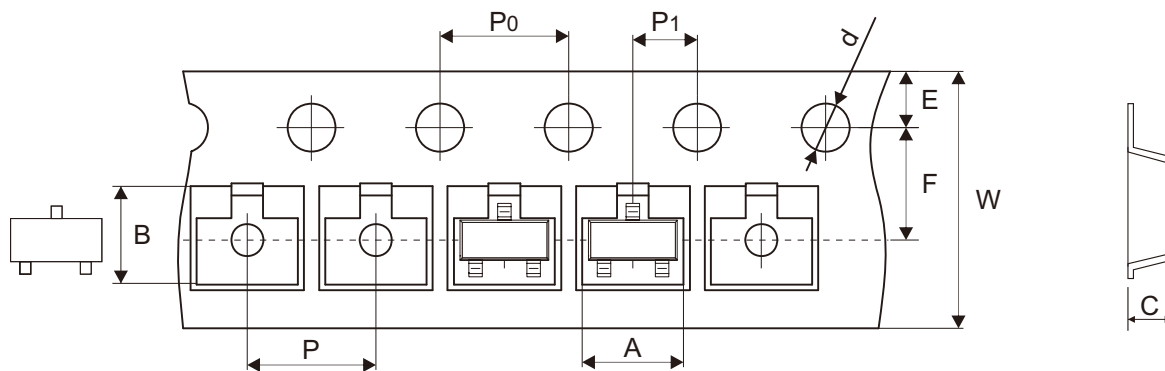

Fig.8 - $P_c - T_a$



Reel Taping Specification



SOT-23	SYMBOL	A	B	C	d	D	D1	D2
	(mm)	3.15 ± 0.10	2.77 ± 0.10	1.22 ± 0.10	1.50 ± 0.10	178.00 ± 2.00	54.40 ± 1.00	13.00 ± 1.00
	(inch)	0.124 ± 0.004	0.109 ± 0.004	0.048 ± 0.004	0.059 ± 0.004	7.008 ± 0.079	2.142 ± 0.039	0.512 ± 0.039

SOT-23	SYMBOL	E	F	P	P0	P1	W	W1
	(mm)	1.75 ± 0.10	3.50 ± 0.10	4.00 ± 0.10	4.00 ± 0.10	2.00 ± 0.10	8.00 ± 0.10	12.30 ± 1.00
	(inch)	0.069 ± 0.004	0.138 ± 0.004	0.157 ± 0.004	0.157 ± 0.004	0.079 ± 0.004	0.315 ± 0.004	0.472 ± 0.039

Marking Code

Part Number	Marking Code
MMBTA06-HF	1GM

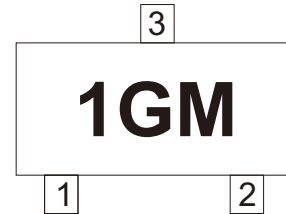

Suggested PAD Layout

SIZE	SOT-23	
	(mm)	(inch)
A	0.90	0.035
B	0.80	0.031
C	0.95	0.037
D	2.00	0.079
E	2.90	0.114

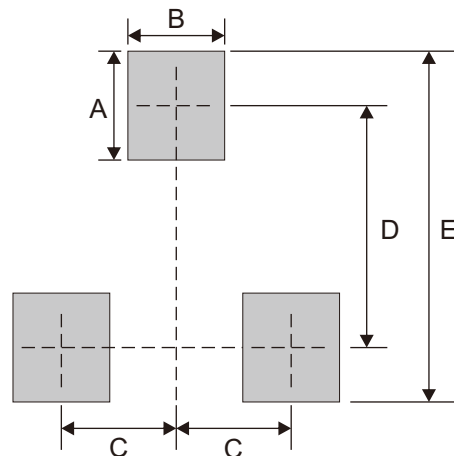

Note: 1. The pad layout is for reference purposes only.

Standard Packaging

Case Type	REEL PACK	
	REEL (pcs)	Reel Size (inch)
SOT-23	3,000	7

X-ON Electronics

Largest Supplier of Electrical and Electronic Components

Click to view similar products for [Bipolar Transistors - BJT category](#):

Click to view products by [Comchip manufacturer](#):

Other Similar products are found below :

[619691C](#) [MCH4017-TL-H](#) [BC546/116](#) [BC557/116](#) [BSW67A](#) [NTE158](#) [NTE187A](#) [NTE195A](#) [NTE2302](#) [NTE2330](#) [NTE63](#) [C4460](#)
[2SA1419T-TD-H](#) [2SA1721-O\(TE85L,F\)](#) [2SA2126-E](#) [2SB1204S-TL-E](#) [2SD2150T100R](#) [SP000011176](#) [FMMTA92QTA](#) [2N2369ADCSM](#)
[2N5769](#) [2SC2412KT146S](#) [2SC5490A-TL-H](#) [2SD1816S-TL-E](#) [2SD1816T-TL-E](#) [CMXT2207 TR](#) [CPH6501-TL-E](#) [MCH4021-TL-E](#)
[US6T6TR](#) [NJL0281DG](#) [732314D](#) [CMXT3906 TR](#) [CPH3121-TL-E](#) [CPH6021-TL-H](#) [873787E](#) [IMZ2AT108](#) [UMX21NTR](#) [MCH6102-TL-E](#)
[NJL0302DG](#) [2N3583](#) [2SA1434-TB-E](#) [2SC3143-4-TB-E](#) [2SD1621S-TD-E](#) [NTE103](#) [30A02MH-TL-E](#) [NSV40301MZ4T1G](#) [NTE101](#) [NTE13](#)
[NTE15](#) [NTE16001](#)