

MP10005G-G Thru. MP1010G-G

Reverse Voltage: 50 to 1000V

Forward Current: 10.0A

RoHS Device

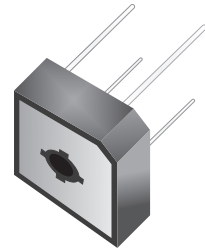

Features

- Surge overload rating -175 amperes peak.
- Low forward voltage drop.
- Small size ; simple installation.
- Sliver plated copper leads.
- UL recognized file # E349301

Mechanical Data

- Polarity: As marked on Body
- Mounting position: Any
- Weight: 7.33 grams

Circuit Diagram

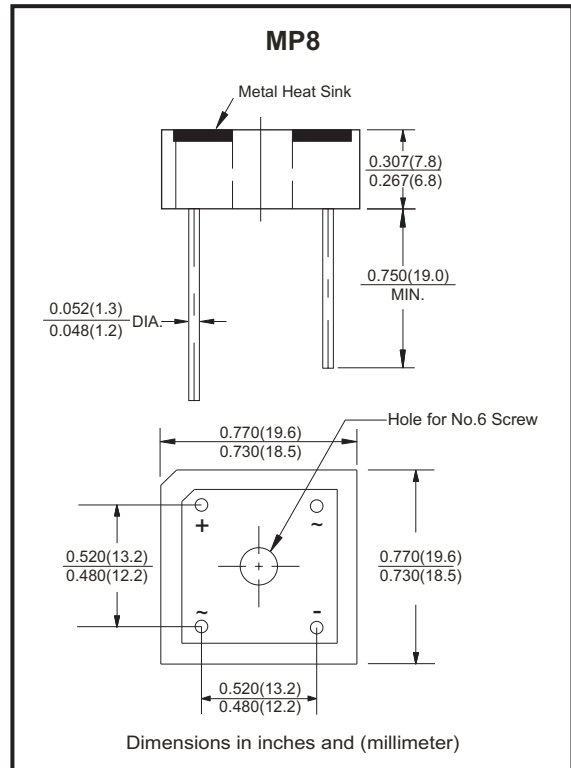
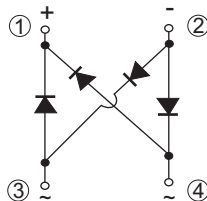

Maximum ratings and electrical characteristics

Rating at 25°C ambient temperature unless otherwise specified.
Single phase, half wave ,60Hz, resistive or inductive load.
For capacitive load, derate current by 20%

Parameter	Symbol	MP10 005G-G	MP10 01G-G	MP10 02G-G	MP10 04G-G	MP10 06G-G	MP10 08G-G	MP10 10G-G	Unit
Maximum Recurrent Peak Reverse Voltage	V_{RRM}	50	100	200	400	600	800	1000	V
Maximum RMS Bridge Input Voltage	V_{RMS}	35	70	140	280	420	560	700	V
Maximum DC Blocking Voltage	V_{DC}	50	100	200	400	600	800	1000	V
Maximum Average Forward Rectified Output Current at $T_A=50^\circ\text{C}$	$I_{(AV)}$	10.0							A
Peak Forward Surge Current, 8.3ms Single Half Sine-Wave Super Imposed On Rated Load	I_{FSM}	175							A
Maximum Forward Voltage Drop Per Bridge Element at 5.0A Peak	V_F	1.1							V
Maximum Reverse Current at Rate $T_J=25^\circ\text{C}$ DC Blocking Voltage Per Element $T_J=100^\circ\text{C}$	I_R	10.0							μA
		1.0							mA
Operating Temperature Range	T_J	-55 to +150							$^\circ\text{C}$
Storage Temperature Range	T_{STG}	-55 to +150							$^\circ\text{C}$

Company reserves the right to improve product design , functions and reliability without notice.

REV: C

Rating and Characteristics Curves (MP10005G-G Thru. MP1010G-G)

Fig.1 - Derating Curve Output Rectified Current

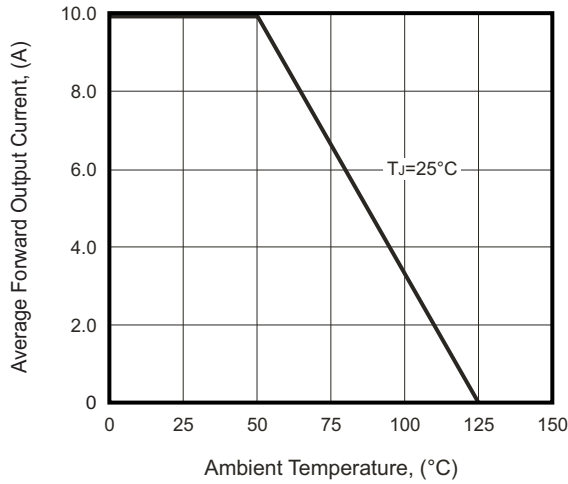

Fig.2 - Maximum Forward Surge Current

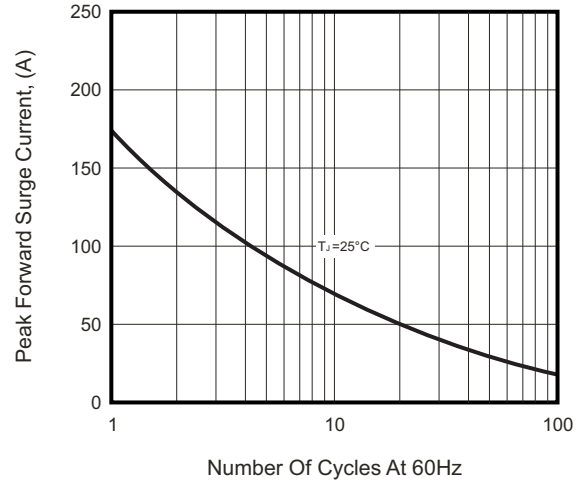

Fig.3 - Typical Forward Characteristics

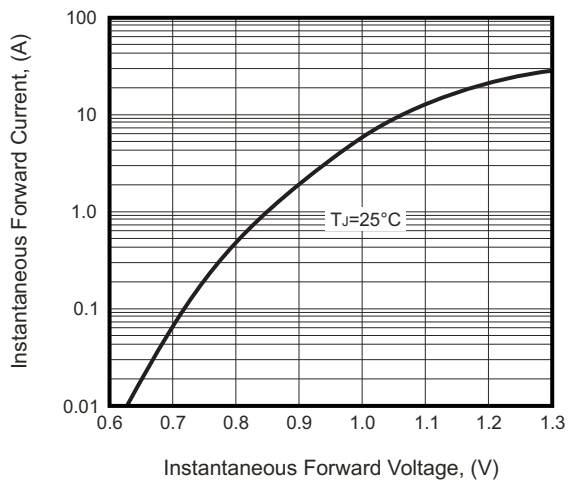
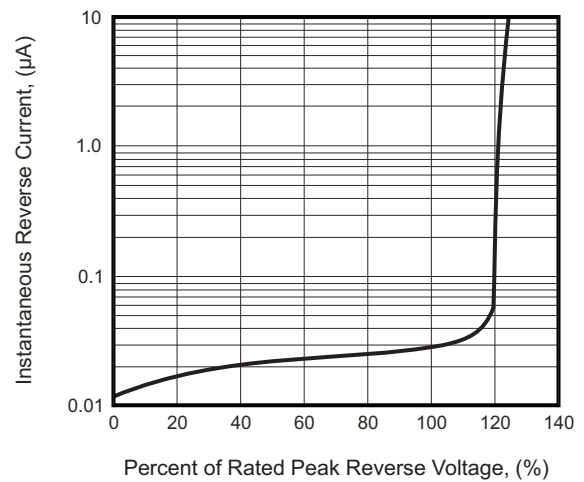
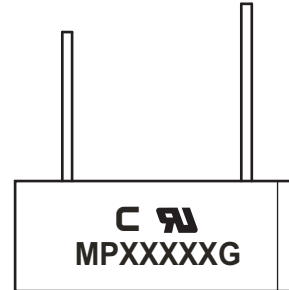

Fig.4 - Typical Reverse Characteristics



Marking Code

Part Number	Marking code
MP10005G-G	MP10005G
MP1001G-G	MP1001G
MP1002G-G	MP1002G
MP1004G-G	MP1004G
MP1006G-G	MP1006G
MP1008G-G	MP1008G
MP1010G-G	MP1010G



XXXXX / XXXX = Product type marking code
C = Compchip Logo

Standard Packaging

Case Type	BULK PACK	
	BOX (pcs)	CARTON (pcs)
MP8	200	2,000

X-ON Electronics

Largest Supplier of Electrical and Electronic Components

Click to view similar products for [Bridge Rectifiers](#) category:

Click to view products by [Comchip](#) manufacturer:

Other Similar products are found below :

[MB2510](#) [MB252](#) [MB356G](#) [MB358G](#) [90MT160KPBF](#) [GBJ1504-BP](#) [GBU15J-BP](#) [GBU15K-BP](#) [GBU4A-BP](#) [GBU4D-BP](#) [GBU6B-E3/45](#)
[GSIB680-E3/45](#) [DB101-BP](#) [DF01](#) [DF10SA-E345](#) [KBPC50-10S](#) [RS405GL-BP](#) [G5SBA60-E3/51](#) [GBU10J-BP](#) [GBU6M](#) [GBU8D-BP](#)
[GBU8J-BP](#) [GSIB1520-E3/45](#) [2KBB10](#) [36MB140A](#) [TB102M](#) [MB1510](#) [MB258](#) [MB6M-G](#) [MB86](#) [TL401G](#) [MDA920A2](#) [TU602](#) [TU810](#)
[BR1005-BP](#) [BR101-BP](#) [BR84DTP204](#) [BU2008-E3/51](#) [36MB100A](#) [KBPC10/15/2501WP](#) [KBPC25-02](#) [VS-2KBB60](#) [DF06SA-E345](#)
[DF1510S](#) [VS-40MT160PAPBF](#) [W02M](#) [GBL02-E3/45](#) [GBU4G-BP](#) [GBJ2506-BP](#) [GBU6B-E3/51](#)