

SECTION 7

CONNECTORS DIN 41617

This traditional connector is still being used in many applications. New designs as well as redesigns of existing systems are manufactured with this series of connectors.

One reason is the proven solid design and the high current carrying capability.





The connector is available in three layouts:
13, 21 and 31 positions in male and female
version with gold or silver plated contacts.
Available termination styles are: solder cup,
straight and right angled PCB solder tails.

In addition a connector converter from
DIN 41617 to DIN EN 60603-2 provides
adaptability to the newer connector series.



TECHNICAL DATA

Material		DIN 41617	DIN 41617 / DIN EN 60603
Insulator		Polycarbonat GF	
Contacts		Copper alloy	
Flammability		UL 94 V-1	
Initial contact resistance		≤ 15 mΩ	≤ 10 mΩ
Initial insulation resistance	Quality class 1	≥ 10 ¹² Ω	≥ 10 ¹¹ Ω
	Quality class 2	≥ 10 ¹¹ Ω	
	Quality class 3	≥ 10 ¹⁰ Ω	
Creepage distance	Contact-Ground	≥ 1 mm	≥ 1.2 mm
	Contact-Contact	≥ 0.5 mm	
Clearance distance	Contact-Ground	≥ 1 mm	≥ 1.2 mm
	Contact-Contact	≥ 1 mm	
Voltage Proof U eff.	Contact-Ground	900 V	1000 V
	Contact-Contact	1150 V	1550 V
Working voltage		250 V depending on insulation coordination (refer to DIN VDE 0110/IEC 664-1)	
Working current	+ 20 °C	Quality class 1 + 2 = 4 A max.	
	+ 70 °C	Quality class 3 = 2 A max.	
	+ 100 °C		
Working temperature	Quality class 1	-65 °C to +125 °C	
	Quality class 2	-55 °C to +125 °C	
	Quality class 3	-25 °C to + 85 °C	
Mating and unmating forces (F max.)	13 pos.	32 N/AU	30 N/AG
	21 pos.	33 N/AU	48 N/AG
	31 pos.	48 N/AU	70 N/AG
		31 + 1 pos. 80 N	
Quality class 3	50 cycles		50 cycles
Quality class 2	400 cycles		400 cycles
Quality class 1	500 cycles		500 cycles
Silver plating		500 cycles	

Technical alterations are subjects to change without notice.

Derating-Diagramm DIN 41617

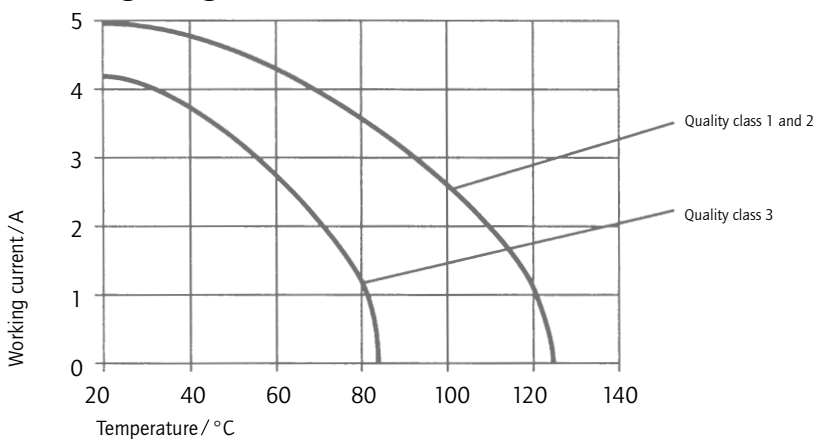

CONNECTOR ACCORDING TO DIN 41617

Male connector – solder lug – 13, 21 and 31 positions

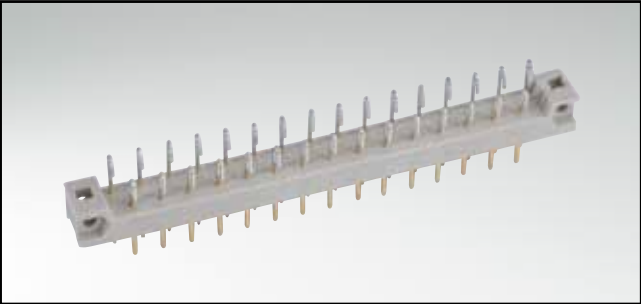

RoHS compliant

DESCRIPTION

- Solder lug
- Contact plating
 - standard quality classes 3 and 2
 - quality class 1 on request (*)
 - hard silver plated
- Special insulator

PRODUCT DRAWING

Panel cutout

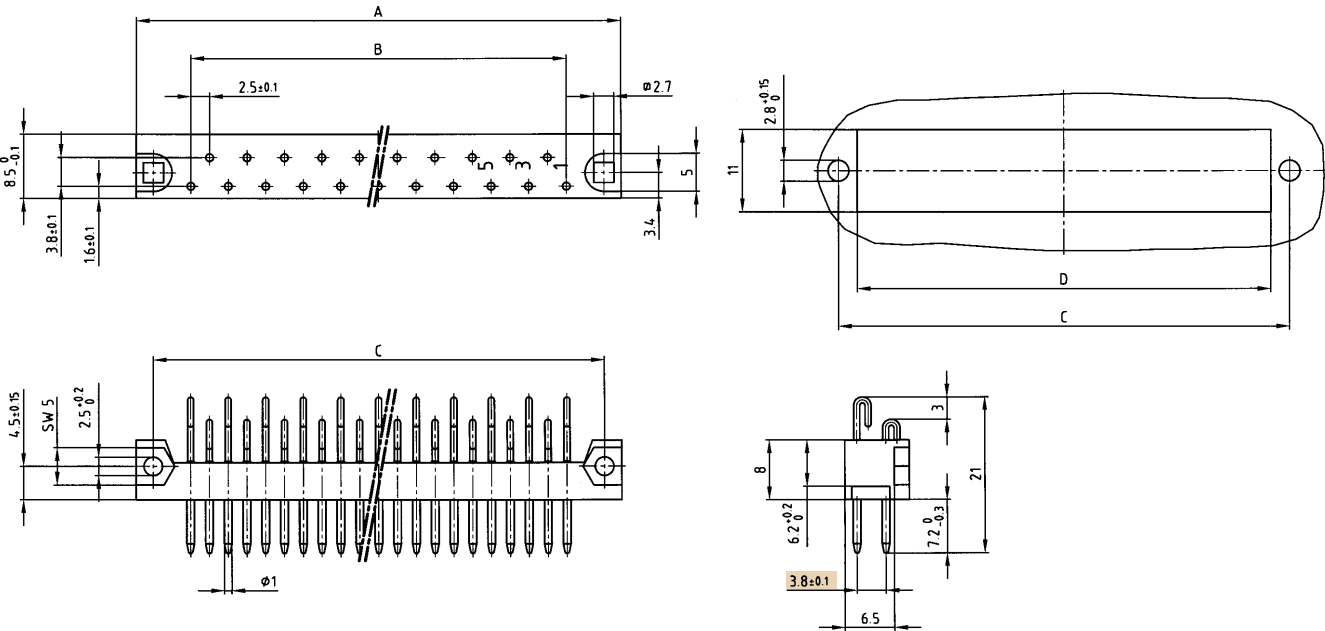

No. of Pos.	A ±0.2	B ±0.1	C ±0.1	D
13	44.6	12x2.5=30	40	35
21	64.6	20x2.5=50	60	55
31	89.6	30x2.5=75	85	80

ORDER DATA

(Dim. = mm)

No. of Pos.	hard silver plated	Quality class 3	Quality class 2	Quality class 1*
13	101 E 10139 X	101 A 10139 X	101 B 10139 X	101 C 10139 X
21	101 E 10149 X	101 A 10149 X	101 B 10149 X	101 C 10149 X
31	101 E 10159 X	101 A 10159 X	101 B 10159 X	101 C 10159 X

CONNECTOR ACCORDING TO DIN 41617

Male connector – straight – 13, 21 and 31 positions

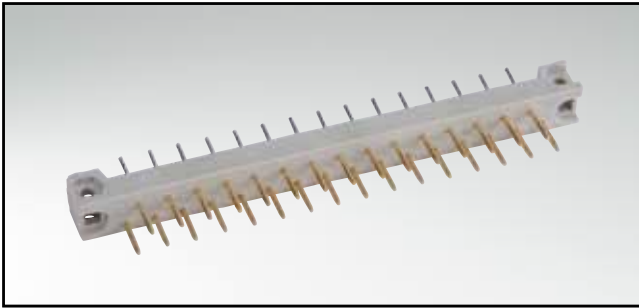

RoHS compliant

DESCRIPTION

- Solder pin
- Contact plating
 - standard quality classes 3 and 2
 - quality class 1 on request (*)
 - hard silver plated
- **Special insulator**

PRODUCT DRAWING

PCB-hole pattern

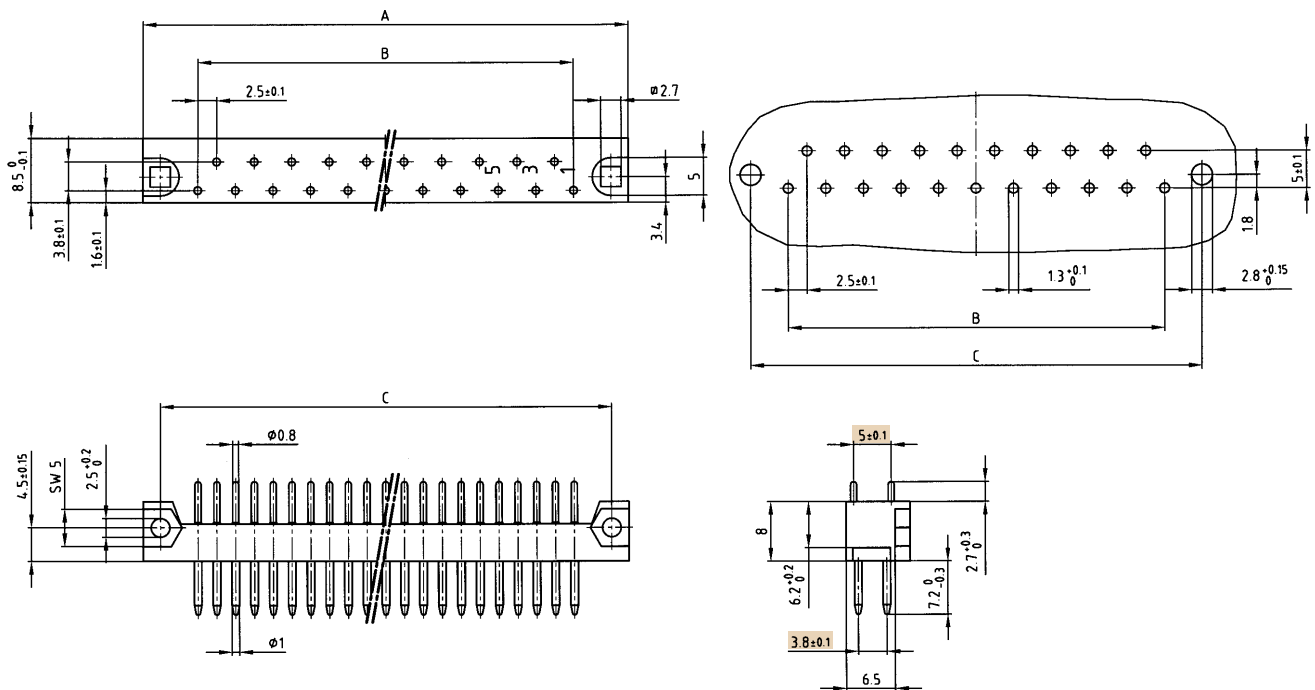

No. of Pos.	A ^{+0.2}	B ^{+0.1}	C ^{+0.1}
13	44.6	12x2.5=30	40
21	64.6	20x2.5=50	60
31	89.6	30x2.5=75	85

ORDER DATA

(Dim. = mm)

No. of Pos.	hard silver plated	Quality class 3	Quality class 2	Quality class 1*
13	101 E 10019 X	101 A 10019 X	101 B 10019 X	101 C 10019 X
21	101 E 10029 X	101 A 10029 X	101 B 10029 X	101 C 10029 X
31	101 E 10039 X	101 A 10039 X	101 B 10039 X	101 C 10039 X

CONNECTOR ACCORDING TO DIN 41617

Male connector – angled – 13, 21 and 31 positions

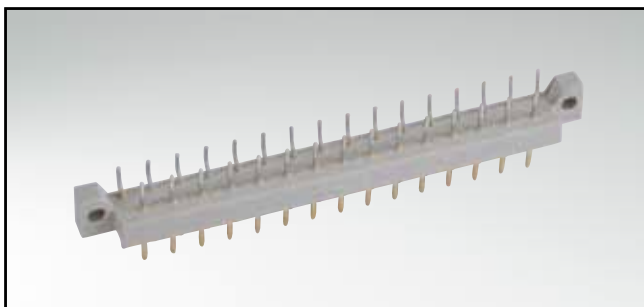

RoHS compliant

DESCRIPTION

- Solder pin
- Contact plating
 - standard quality classes 3 and 2
 - quality class 1 on request (*)
 - hard silver plated
- Standard insulator

PRODUCT DRAWING

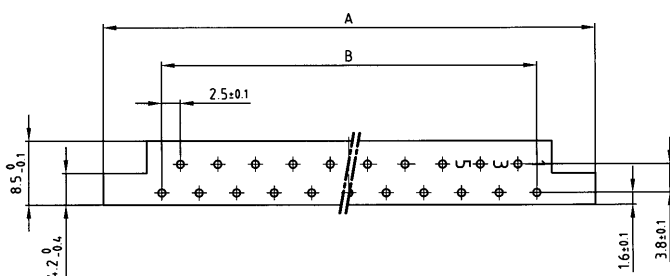

PCB-hole pattern

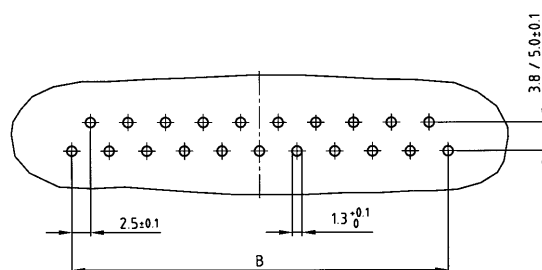

Contact spacing

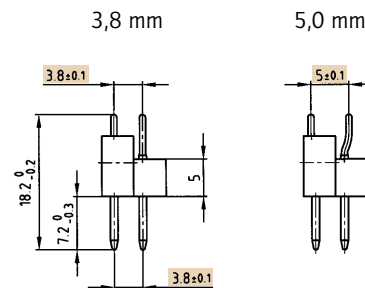
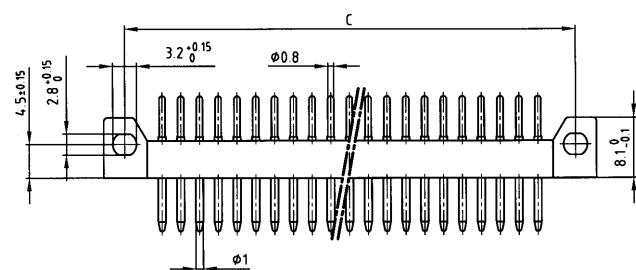

No. of Pos.	A ±0.2	B ±0.1	C ±0.1
13	45.6	12x2.5=30	40
21	65.6	20x2.5=50	60
31	89.6	30x2.5=75	85

ORDER DATA

(Dim. = mm)

No. of Pos.	Contact spacing	hard silver plated	Quality class 3	Quality class 2	Quality class 1 *
13	3.8 mm	101 E 10049 X	101 A 10049 X	101 B 10049 X	101 C 10049 X
13	5.0 mm	101 E 10169 X	101 A 10169 X	101 B 10169 X	101 C 10169 X
21	3.8 mm	101 E 10059 X	101 A 10059 X	101 B 10059 X	101 C 10059 X
21	5.0 mm	101 E 10179 X	101 A 10179 X	101 B 10179 X	101 C 10179 X
31	3.8 mm	101 E 10069 X	101 A 10069 X	101 B 10069 X	101 C 10069 X
31	5.0 mm	101 E 10189 X	101 A 10189 X	101 B 10189 X	101 C 10189 X

CONNECTOR ACCORDING TO DIN 41617

Male connector – angled – 13, 21 and 31 positions

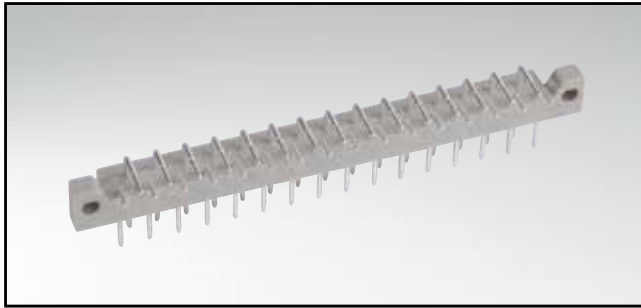

RoHS compliant

DESCRIPTION

- Solder pin
- Contact plating
 - standard quality classes 3 and 2
 - quality class 1 on request (*)
 - hard silver plated
- Standard insulator

PRODUCT DRAWING

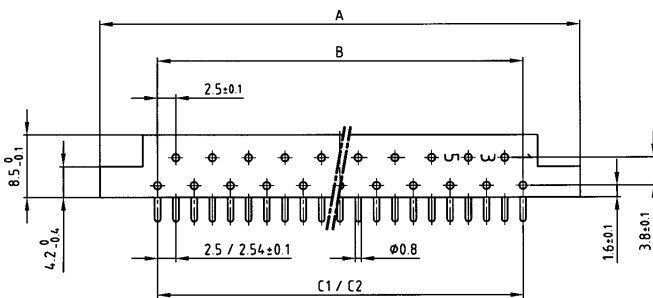

PCB-hole pattern

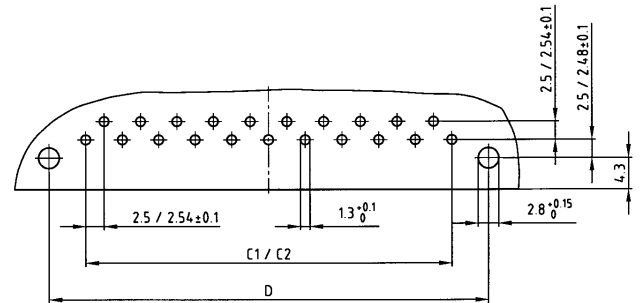

Contact spacing

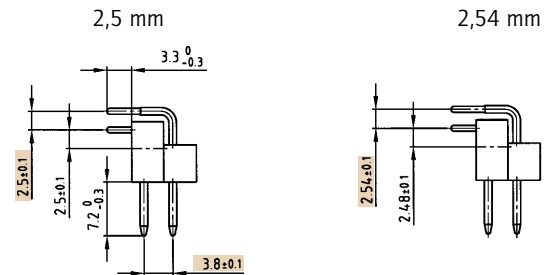
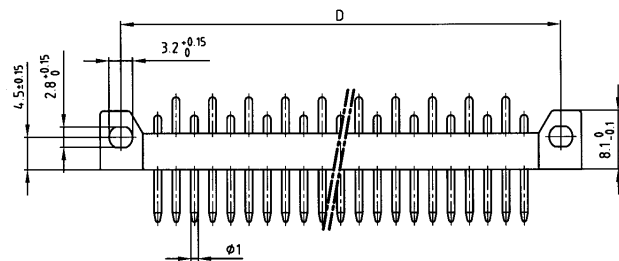

No. of Pos.	A ±0.2	B ±0.1	C ₁ ±0.1	C ₂ ±0.1	D ±0.1
13	45.6	12x2.5=30	12x2.5=30	12x2.54=30.48	40
21	65.6	20x2.5=50	20x2.5=50	20x2.54=50.80	60
31	90.6	30x2.5=75	30x2.5=75	30x2.54=75.20	85

ORDER DATA

(Dim. = mm)

No. of Pos.	Contact spacing	hard silver plated	Quality class 3	Quality class 2	Quality class 1 *
13	2.50 mm	101 E 10079 X	101 A 10079 X	101 B 10079 X	101 C 10079 X
13	2.54 mm	101 E 10089 X	101 A 10089 X	101 B 10089 X	101 C 10089 X
21	2.50 mm	101 E 10099 X	101 A 10099 X	101 B 10099 X	101 C 10099 X
21	2.54 mm	101 E 10109 X	101 A 10109 X	101 B 10109 X	101 C 10109 X
31	2.50 mm	101 E 10119 X	101 A 10119 X	101 B 10119 X	101 C 10119 X
31	2.54 mm	101 E 10129 X	101 A 10129 X	101 B 10129 X	101 C 10129 X

CONNECTOR ACCORDING TO DIN 41617

Female connector – solder lug – 13, 21 and 31 positions

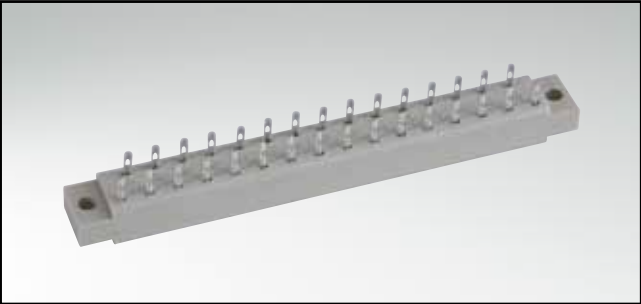

RoHS compliant

DESCRIPTION

- Solder lug
- Contact plating
 - standard quality classes 3 and 2
 - quality class 1 on request (*)
 - hard silver plated

PRODUCT DRAWING

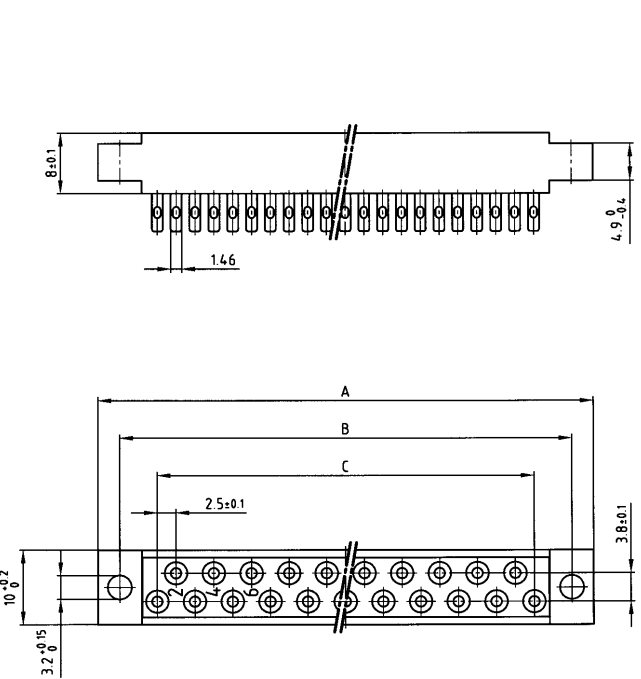

Panel cutout

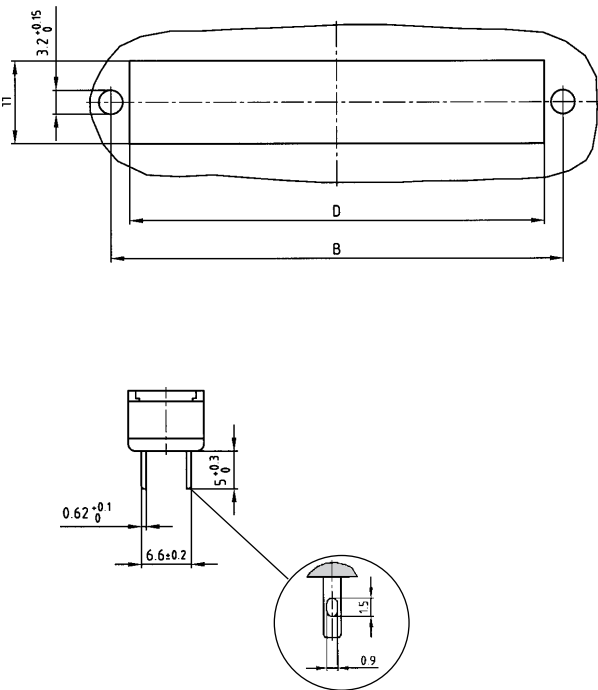

No. of Pos.	A ±0.3	B ±0.1	C ±0.1	D
13	45.8	40	12x2.5=30	35
21	65.8	60	20x2.5=50	55
31	90.8	85	30x2.5=75	80

ORDER DATA

(Dim. = mm)

No. of Pos.	hard silver plated	Quality class 3	Quality class 2	Quality class 1*
13	102 E 10019 X	102 A 10019 X	102 B 10019 X	102 C 10019 X
21	102 E 10029 X	102 A 10029 X	102 B 10029 X	102 C 10029 X
31	102 E 10039 X	102 A 10039 X	102 B 10039 X	102 C 10039 X

CONNECTOR ACCORDING TO DIN 41617

Female connector – straight – 13, 21 and 31 positions

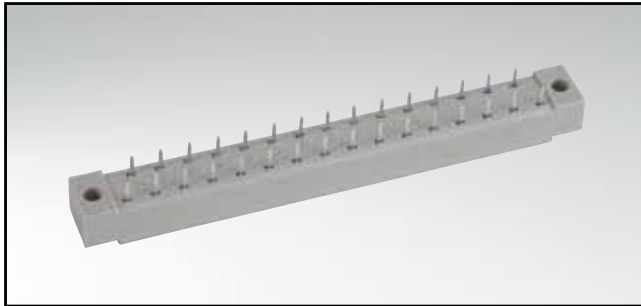

RoHS compliant

DESCRIPTION

- Solder pin
- Insulator "set up" (A) or "connected" (D)
- Contact plating
 - standard quality classes 3 and 2
 - quality class 1 on request (*)
 - hard silver plated

PRODUCT DRAWING

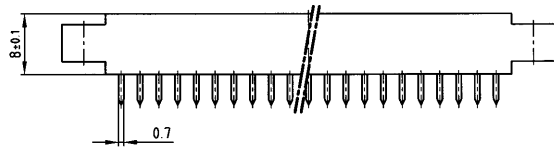

PCB-hole pattern

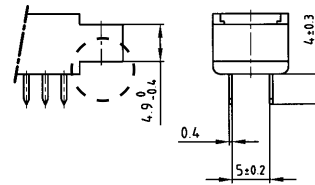
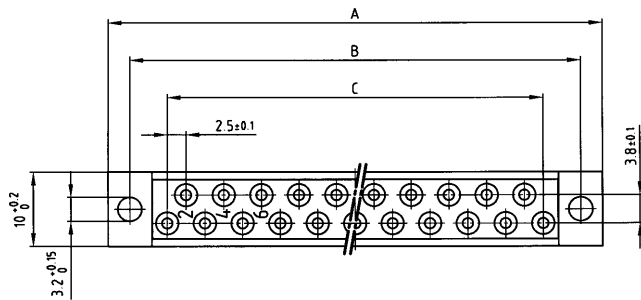
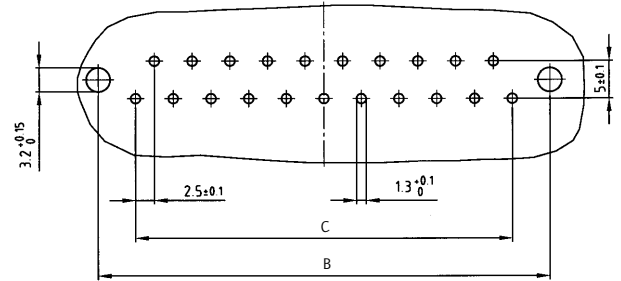

Version A
"set up"

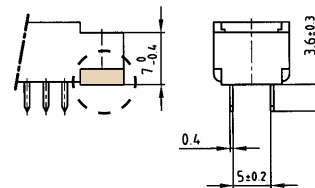

Version D
"connected"

No. of Pos.	A -0.3	B ±0.1	C ±0.1
13	45.8	40	12x2.5=30
21	65.8	60	20x2.5=50
31	90.8	85	30x2.5=75

ORDER DATA

(Dim. = mm)

No. of Pos.	Insulator	hard silver plated	Quality class 3	Quality class 2	Quality class 1 *
13	Version A	102 E 10049 X	102 A 10049 X	102 B 10049 X	102 C 10049 X
13	Version D	102 E 10059 X	102 A 10059 X	102 B 10059 X	102 C 10059 X
21	Version A	102 E 10069 X	102 A 10069 X	102 B 10069 X	102 C 10069 X
21	Version D	102 E 10079 X	102 A 10079 X	102 B 10079 X	102 C 10079 X
31	Version A	102 E 10089 X	102 A 10089 X	102 B 10089 X	102 C 10089 X
31	Version D	102 E 10099 X	102 A 10099 X	102 B 10099 X	102 C 10099 X

CONNECTOR ACCORDING TO DIN 41617 / DIN EN 60603-2

Converter female connector – 31 / 32 positions

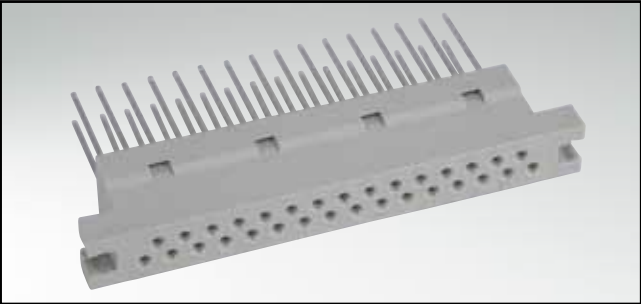

RoHS compliant

DESCRIPTION

- Wire Wrap and solder lug
- Quality class 1 (Standard)
- Mating side with 31 contacts
- Connecting side with 32 contacts (one contact not contacted)

PRODUCT DRAWING

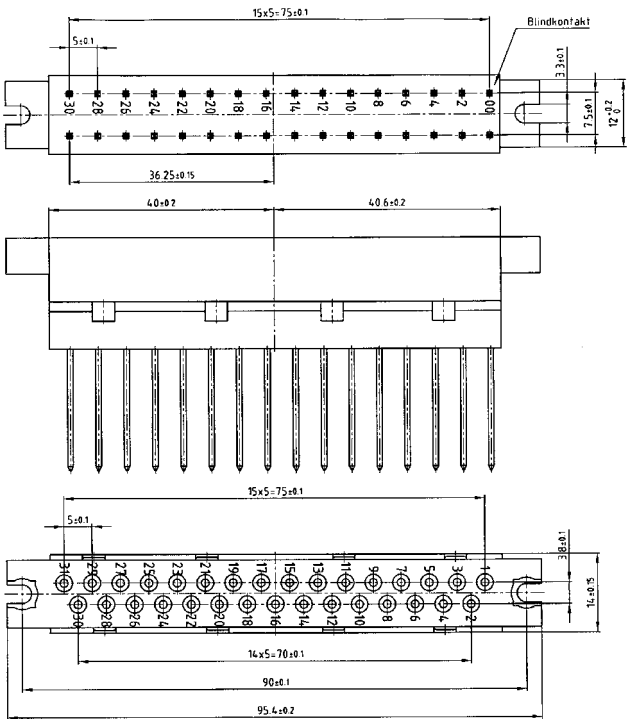

Panel cutout

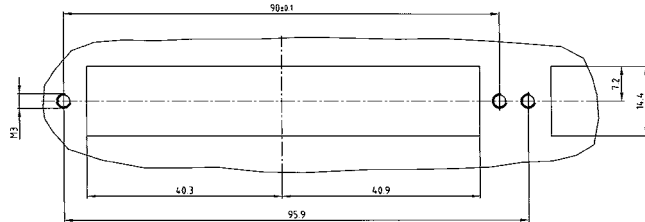

Solder lug

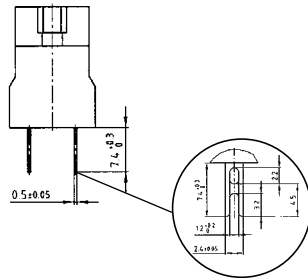

Wire Wrap

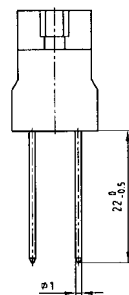

(Dim. = mm)

ORDER DATA

No. of Pos.	Quality class	Solder lug	Wire Wrap
31/32	1	122 C 13019 X	122 C 13069 X

X-ON Electronics

Largest Supplier of Electrical and Electronic Components

Click to view similar products for [DIN 41612 Connectors](#) category:

Click to view products by [CONEC](#) manufacturer:

Other Similar products are found below :

[004.767](#) [602427301412000](#) [608489050008049](#) [691327-1](#) [74680-0340](#) [9732967801](#) [QLC260R](#) [120X10019X](#) [121A04879A](#) [121A10039X](#)
[121A10309X](#) [121A10439X](#) [122A11089X](#) [122A10089X](#) [122A10349X](#) [122E11709X](#) [DIN-048CPC-SR1-MH](#) [1393726-7](#) [143-1908-000](#)
[1484472-1](#) [CBC20T00-008FDS5-0-1-002VR](#) [172699-5036](#) [2-1393557-4](#) [419-2080-402](#) [419-2085-302](#) [538457096000009](#) [419-2086-201](#)
[419-2087-002](#) [02990000004](#) [033020](#) [054302](#) [09062483201750](#) [09061486901840](#) [09185107324800](#) [101A10079X](#) [101B10079X](#)
[86093967113H55SRLF](#) [5148655-5](#) [166397-1](#) [9031646921](#) [2010962111](#) [V23533B2151G605](#) [AWL254DAG08D](#) [9732646801](#) [1-5533429-2](#)
[10-507820-326](#) [10-507820-U23](#) [148691-1](#) [148684-1](#) [148689-1](#)