

**Technical specification:**

**Technische Daten:**

Working voltage/  
Betriebsspannung: 250 V AC

Initial contact  
resistance/  
Anfangs-  
Durchgangswiderstand:  $\leq 20 \text{ m}\Omega$

Temperature range/  
Temperaturbereich:  $-55 \text{ }^\circ\text{C} \dots +125 \text{ }^\circ\text{C}$

Mating cycles/  
Steckzyklen: Quality class 1 = 500  
Gütestufe 1  
Quality class 2 = 400  
Gütestufe 2  
Quality class 3 = 50  
Gütestufe 3

**Materials/**

**Werkstoffe:**

Contact/  
Kontakt: Cu alloy, Au over Ni



Insulator/  
Isolierkörper: PBT GF UL 94 V-0, grey/grau

**Installation specification/**

**Montagedaten:**

PCB-Hole drillings/  
Leiterplattenbohrbild: see Sheet 2/  
siehe Seite 2

Part no. / Part marked Art.-Nr. / Bedruckung:	Quality class / Gütestufe:	Contact plating/ Kontakt Veredelung:
122A10669X	3	Gold over nickel / 50 mating cycles Gold über Nickel / 50 Steckzyklen
122B10669X	2	Gold over nickel / 400 mating cycles Gold über Nickel / 400 Steckzyklen
122C10669X	1	Gold over nickel / 500 mating cycles Gold über Nickel / 500 Steckzyklen



		 dim. in mm	<b>Female Connector Type "C/2"</b> <b>48pos. Solder pin straight 2,5mm</b> <i>Federleiste Type "C/2"</i> <b>48pol. Lötstift gerade 2,5mm</b>	
				
drawn/ gez.	30.08.2001	Name Parei		
appd./ gepr.	30.08.2001	E. Mickenbecker		
Index: b Ä6942 06.11.2017 L.U.	scale/Maßstab: 2:1		dwg no / Z.-nr.: 12K1A165A	DIN- A3
Status: InBearbeitung				1 / 2
RoHS compliant/konform				

The reproduction, distribution and utilization of this document as well as the communication of its contents to others without express authorization is prohibited. Offenders will be held liable for the payment of damages. Wir bitten Sie, die Weitergabe, Verbreitung und Nutzung dieses Dokuments, sowie die Kommunikation seiner Inhalte an Dritte ohne schriftliche Genehmigung des Herstellers zu unterlassen. Zuwiderhandlungen werden entsprechend geltender Gesetze geahndet.

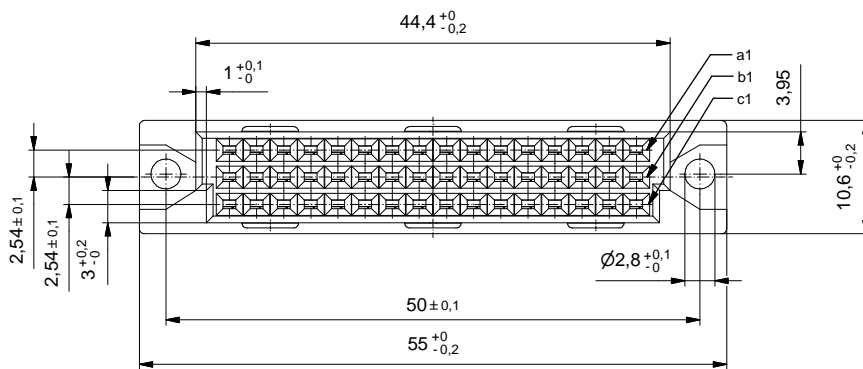
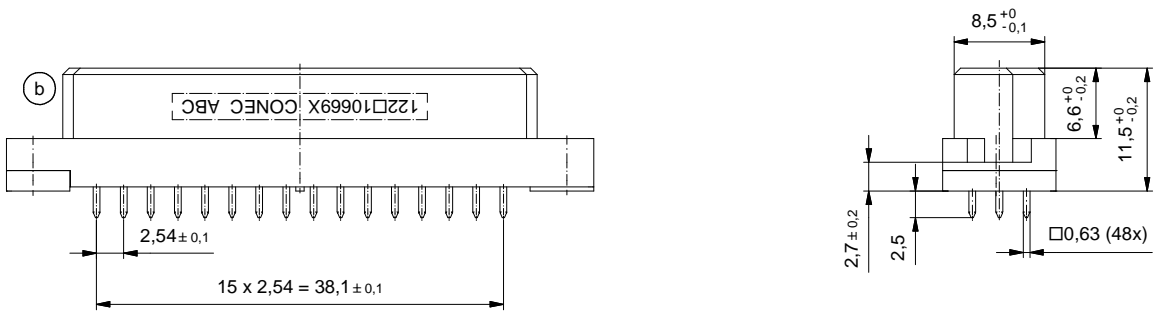
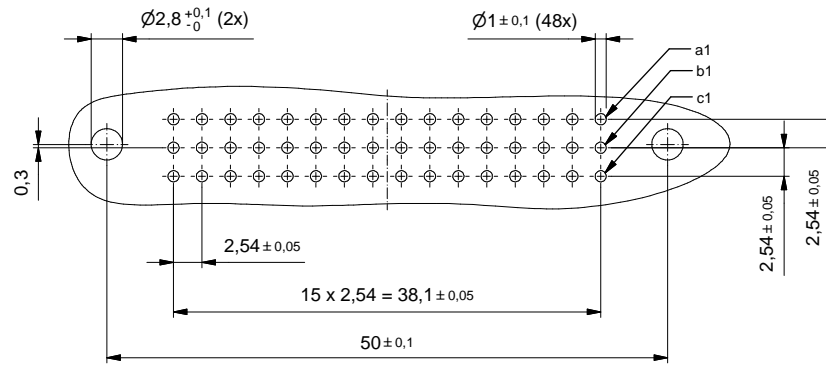
PCB hole drillings ( PCB top side )  
 Leiterplattenbohrbild ( Leiterplatten Oberseite )



The reproduction, distribution and utilization of this document as well as the communication of its content to others without express authorization is prohibited. Offenders will be held liable for the payment of damages. We reserve the right to withdraw advertising and notices, in whole or in part, without notice and without liability.

		 dim. in mm		Female Connector Type "C/2" 48pos. Solder pin straight 2,5mm Federleiste Type "C/2" 48pol. Lötstift gerade 2,5mm			
		Date/Datum	Name				
		drawn/gez.	30.08.2001			Parsi	
Index: b Ä6942 06.11.2017 L.U.		appd./gepr.	30.08.2001	E. Mickenbecker			
Status: InBearbeitung	scale/Maßstab: 2:1			dwg no / Z.-nr.: 12K1A165A			
RoHS compliant/konform						DIN-A3 2/2	

## X-ON Electronics

Largest Supplier of Electrical and Electronic Components

*Click to view similar products for [DIN 41612 Connectors](#) category:*

*Click to view products by [CONEC](#) manufacturer:*

Other Similar products are found below :

[004.767](#) [608489050008049](#) [691327-1](#) [74670-0732](#) [74680-0340](#) [75880-0015](#) [76453-0014](#) [86093159ALF](#) [9732967801](#) [QLC260R](#)  
[120X10019X](#) [120X10089X](#) [122A10249X](#) [122A11089X](#) [122A13089X](#) [122A10089X](#) [122A10129X](#) [122A10349X](#) [122A13359X](#) [1377391-4](#)  
[DIN-048CPC-SR1-MH](#) [1393583-2](#) [1393726-7](#) [140X10129X](#) [143-1913-000](#) [143-1908-000](#) [1484472-1](#) [2110070-1](#) [2110070-2](#) [CBC20T00-](#)  
[008FDS5-0-1-002VR](#) [172699-5036](#) [2-1393557-4](#) [2-1437084-2](#) [394506](#) [419-2080-402](#) [419-2085-302](#) [V42254B2202C968](#) [419-2086-201](#) [419-](#)  
[2087-002](#) [448657-1](#) [448847-3](#) [5-1393755-9](#) [02990000004](#) [033020](#) [043619](#) [054302](#) [043556](#) [0760557108](#) [09062483201750](#) [0850033067](#)