

## D-Subminiature connectors

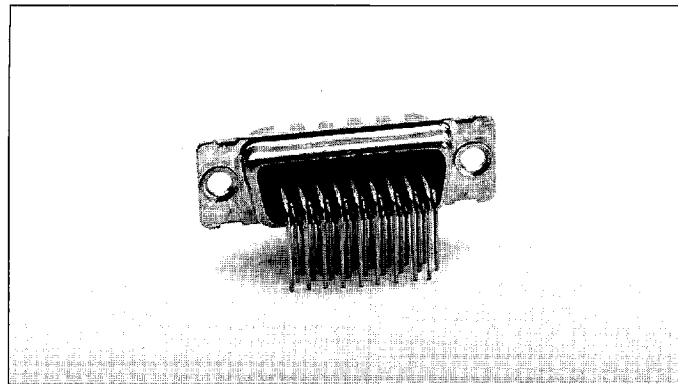

•350 inch

Solder pin angled high density

Socket connector

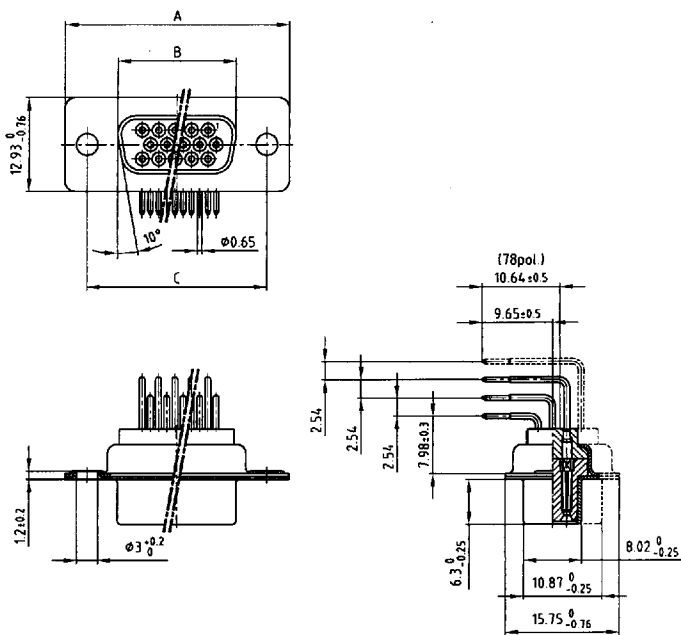

Plug connector

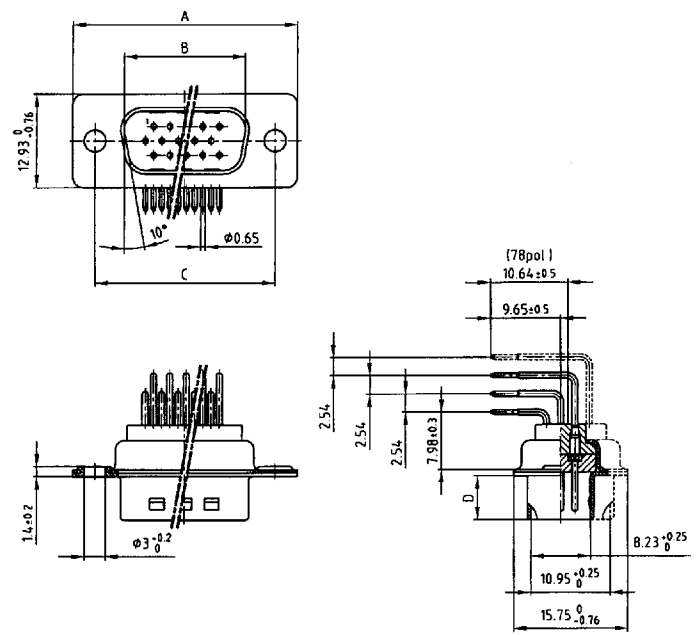

Kat 1 i N0A

No. of pos.	A - 0,76	B - 0,25	C
15	31,19	16,46	$25,00 \pm 0,12$
26	39,52	24,79	$33,30 \pm 0,15$
44	53,42	38,50	$47,04 \pm 0,13$
62	69,70	54,96	$63,50 \pm 0,13$
78	67,31	52,55	$61,10 \pm 0,11$

Kat 1 i N1A

No. of pos.	A - 0,76	B + 0,25	C	D - 0,30
15	31,19	16,79	$25,00 \pm 0,12$	6,12
26	39,52	25,12	$33,30 \pm 0,15$	6,12
44	53,42	38,84	$47,04 \pm 0,13$	5,99
62	69,70	55,30	$63,50 \pm 0,13$	5,99
78	67,31	52,68	$61,10 \pm 0,11$	5,99

## Part numbers

No. of Pos.	Socket connector tin-plated – solder pin angled
15	CDF 15 AHDSN 164 A 17889 X
26	CDF 26 AHDSN 164 A 17899 X
44	CDF 44 AHDSN 164 A 17909 X
62	CDF 62 AHDSN 164 A 17919 X
78	CDF 78 AHDSN 164 A 17929 X

No. of Pos.	Plug connector tin-plated with ground indent – solder pin angled
15	CDS 15 AFHDSN 163 A 17479 X
26	CDS 26 AFHDSN 163 A 17489 X
44	CDS 44 AFHDSN 163 A 17499 X
62	CDS 62 AFHDSN 163 A 17509 X
78	CDS 78 AFHDSN 163 A 17519 X

### Part Number

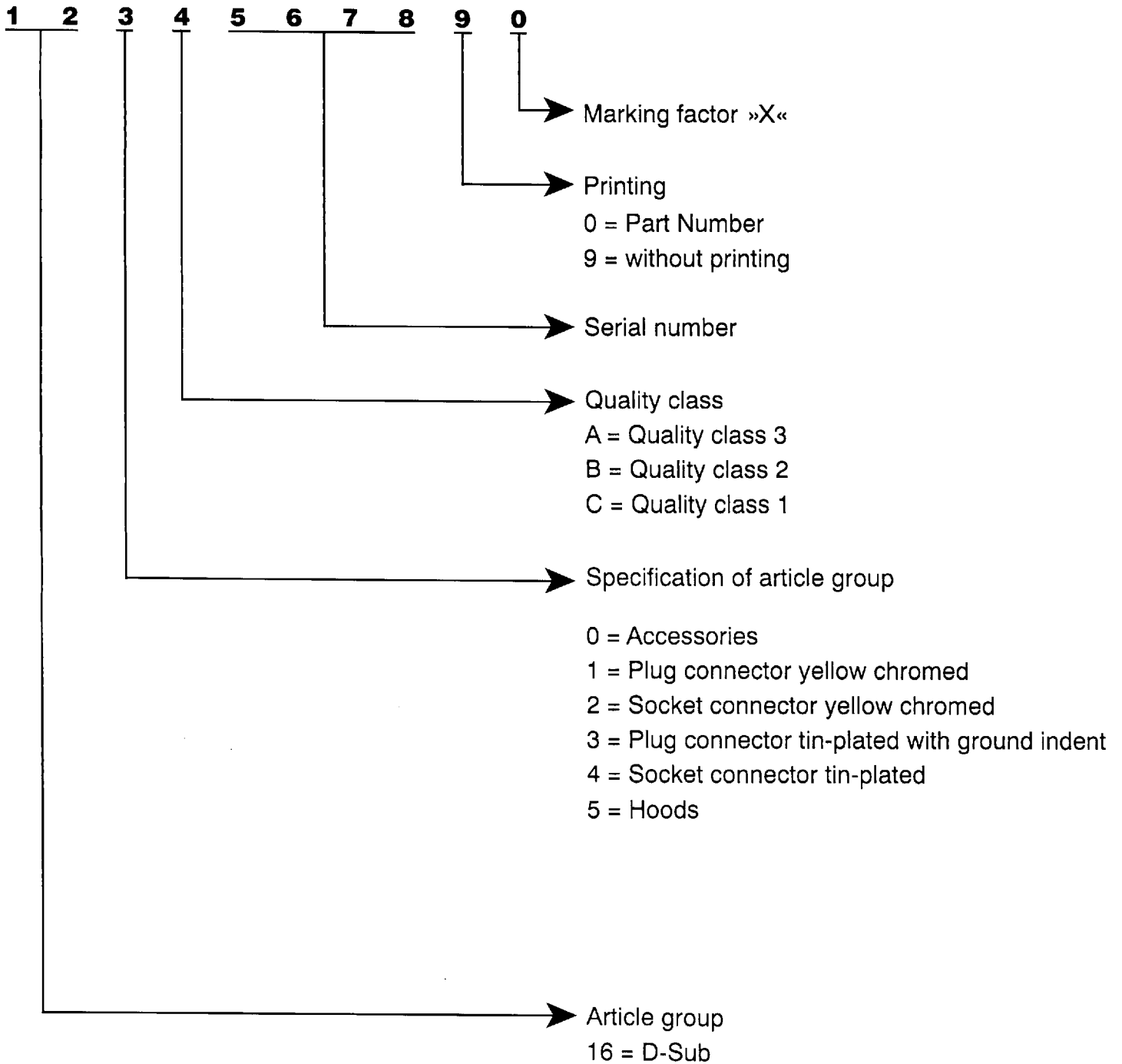

### Order example

Plug connector Solder bucket 25 pos. without printing	
Quality class	Part Number
3	CDS 25 L <b>161 A 10039 X</b>
2	CDS 25 L <b>161 B 10039 X</b>
1	CDS 25 L <b>161 C 10039 X</b>

9017935 0000071 237

## Hole pattern for angled solder pins D-Sub high density

Socket connector solder pin angled

Plug connector solder pin angled

15 pos

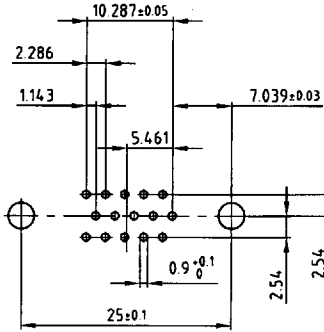

15 pos

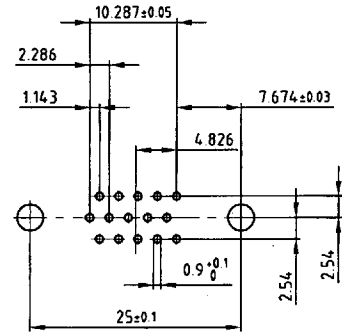

26 pos

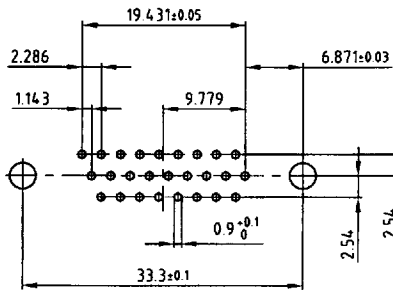

26 pos

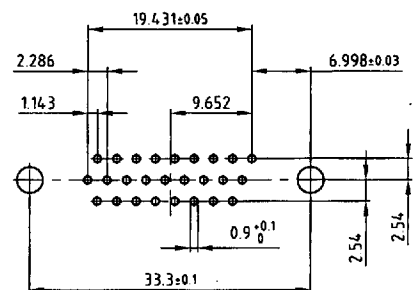

44 pos

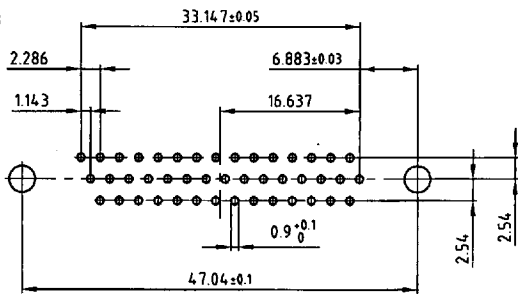

44 pos

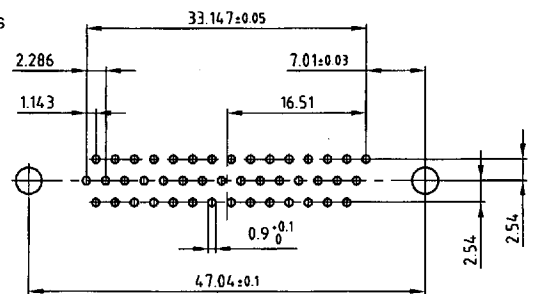

62 pos

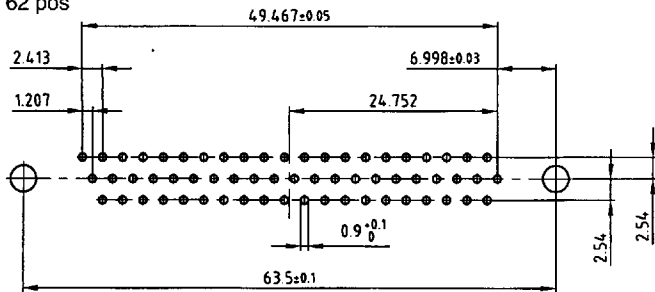

62 pos

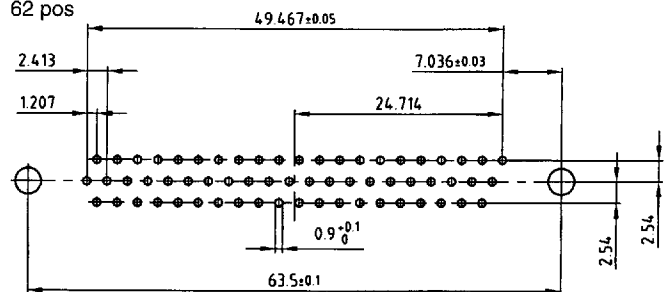

78 pos

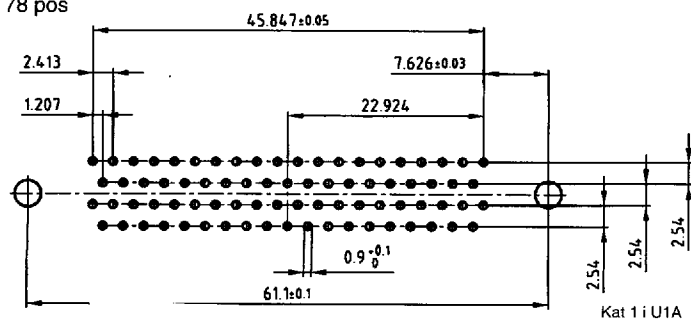

78 pos

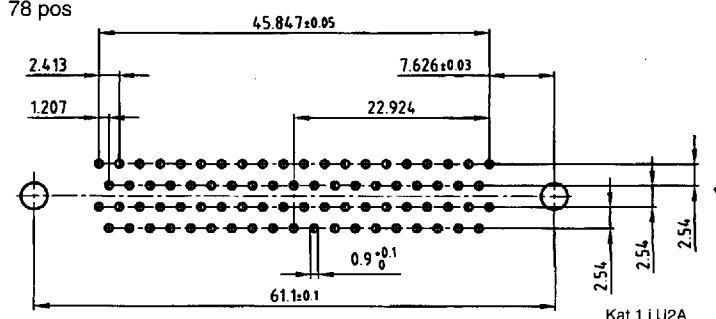

Technical Data	D-Sub Standard	D-Sub High Density
Initial contact resistance	≤ 10 mΩ	≤ 10 mΩ
Initial insulation resistance	Quality class 1 ≥ 5GΩ Quality class 2 ≥ 5GΩ Quality class 3 ≥ 5GΩ	Quality class 1 ≥ 5GΩ Quality class 2 ≥ 5GΩ Quality class 3 ≥ 5GΩ
Clearance distance	contact–contact ≥ 1.0 mm contact–ground ≥ 1.2 mm	≥ 0.6 mm
Creepage distance	contact–contact ≥ 1.0 mm contact–ground ≥ 1.2 mm	≥ 0.6 mm
Test voltage v. r. m. s./NM	1000 V	1000 V
Working voltage/Insulation group* * nach SEV 50 V – acc. to SEV 50 V	125 V ≈	60 V ≈
Working current 20° C	5 A max.	25 A max.
Operating temperature	- 55° C – + 125° C	- 55° C – + 125° C
Moulding material	Polyester GF UL 94 V-O	PA 6.6 GF 25 UL 94 V-O
Contact material	Copper alloy	Copper alloy
Contact finish	hard-gold-plated over nickel	hard-gold-plated over nickel
Shell	Sheet steel, zinc lined and yellow chromate Sheet steel, nickel underneath and tin-plated	Sheet steel, nickel underneath and tin-plated
Insertion and withdrawal forces	9-polig/way 30 N 15-polig/way 50 N 25-polig/way 83 N 37-polig/way 123 N 50-polig/way 167 N	15-polig/way 50 N 26-polig/way 84 N 44-polig/way 120 N 62-polig/way 170 N 78-polig/way 200 N
Quality classes	Quality class 1 Quality class 2 Quality class 3	500 mating cycles 200 mating cycles 50 mating cycles

## X-ON Electronics

Largest Supplier of Electrical and Electronic Components

*Click to view similar products for [D-Sub High Density Connectors](#) category:*

*Click to view products by [CONEC](#) manufacturer:*

Other Similar products are found below :

[97-3250-11](#) [163A17089X](#) [164A17199X](#) [164C18629X](#) [L717HDB44POL2R210](#) [L717HDEH15POL2](#) [L777HDE15P](#) [L77HDE15SC309](#)  
[163A16759X](#) [163A16839X](#) [163A16989X](#) [163A17079X](#) [164A17329X](#) [164A18219X](#) [241A16440X](#) [241A16550X](#) [241A16680X](#)  
[241A20810X](#) [241A25740X](#) [CT25-44P](#) [MDBE15PE766](#) [L177HDE15SOL2RM23](#) [L177HRC62SVFM](#) [L177HRCG62S](#)  
[L717HDEG15POL2RM5](#) [L77HDA26SVF](#) [L77HDE15SD1CO](#) [L77HDEH15SOL2RM832](#) [DAMA-15S-WS](#) [443895-3](#) [106698-1](#) [280-](#)  
[012K2C](#) [DBMV13H3SNA197](#) [L177HRB44S](#) [164A17039X](#) [09562004701510](#) [L777HRC62P](#) [241A17960X](#) [164A18269X](#) [280-019S1S9MEN](#)  
[L777HDEG15P](#) [280-018P3S25MEGN](#) [206504-2](#) [40-9515HDSP](#) [2057140-1](#) [C115370-6002](#) [DFMA104SNMBFR172FR022](#) [HDC9F200E2S](#)  
[L717HDAG26POL2RM8](#) [241A28180X](#)