

•590 inch

Solder pin angled with threaded insert and short metal bracket

Socket connector

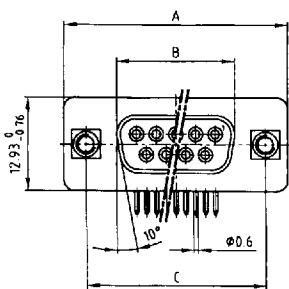

Plug connector

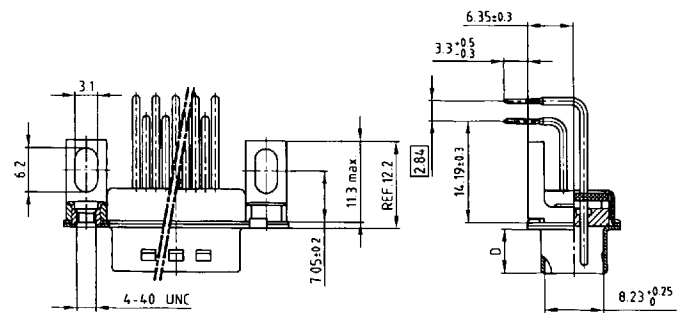
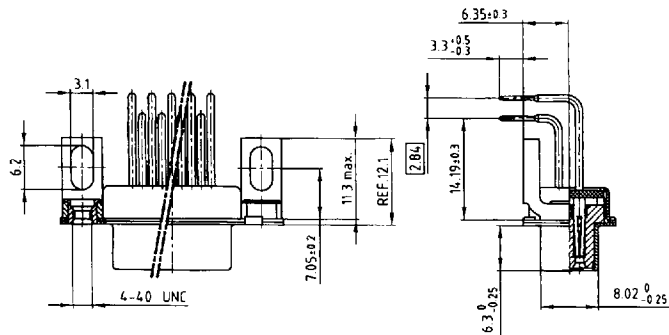
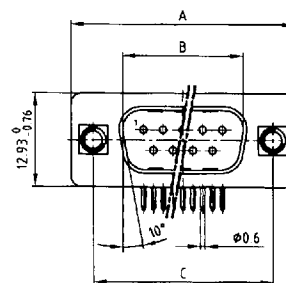

Kat 1 i S6A

| No. of pos. | A - 0.76 | B - 0.25 | C |
|-------------|----------|----------|---|
| 9 | 31,19 | 16,46 | 25,00 ^{+0.12} / _{-0.13} |
| 15 | 39,52 | 24,79 | 33,30 ^{+0.15} / _{-0.16} |
| 25 | 53,42 | 38,50 | 47,04 ^{+0.13} / _{-0.14} |
| 37 | 69,70 | 54,96 | 63,50 ^{+0.13} / _{-0.14} |

Kat 1 i S7A

| No. of pos. | A - 0.76 | B + 0.25 | C | D - 0.30 |
|-------------|----------|----------|---|----------|
| 9 | 31,19 | 16,79 | 25,00 ^{+0.12} / _{-0.13} | 6,12 |
| 15 | 39,52 | 25,12 | 33,30 ^{+0.15} / _{-0.16} | 6,12 |
| 25 | 53,42 | 38,84 | 47,04 ^{+0.13} / _{-0.14} | 5,99 |
| 37 | 69,70 | 55,30 | 63,50 ^{+0.13} / _{-0.14} | 5,99 |

Part numbers

| No. of Pos. | Socket connector – Solder pin angled | | | |
|-------------|--------------------------------------|---------------|---------------|---------------|
| | Typ 1 | Typ 3 | Typ 4 | Typ 5 |
| 9 | 242 A 20130 X | 242 A 20170 X | 242 A 20210 X | 242 A 20250 X |
| 15 | 242 A 20140 X | 242 A 20180 X | 242 A 20220 X | 242 A 20260 X |
| 25 | 242 A 20150 X | 242 A 20190 X | 242 A 20230 X | 242 A 20270 X |
| 37 | 242 A 20160 X | 242 A 20200 X | 242 A 20240 X | 242 A 20280 X |

| No. of Pos. | Plug connector – Solder pin angled | | | |
|-------------|------------------------------------|---------------|---------------|---------------|
| | Typ 1 | Typ 3 | Typ 4 | Typ 5 |
| 9 | 241 A 20280 X | 241 A 20320 X | 241 A 20360 X | 241 A 20400 X |
| 15 | 241 A 20290 X | 241 A 20330 X | 241 A 20370 X | 241 A 20410 X |
| 25 | 241 A 20300 X | 241 A 20340 X | 241 A 20380 X | 241 A 20420 X |
| 37 | 241 A 20310 X | 241 A 20350 X | 241 A 20390 X | 241 A 20430 X |

9017935 0000051 449

Filter connectors

Part number

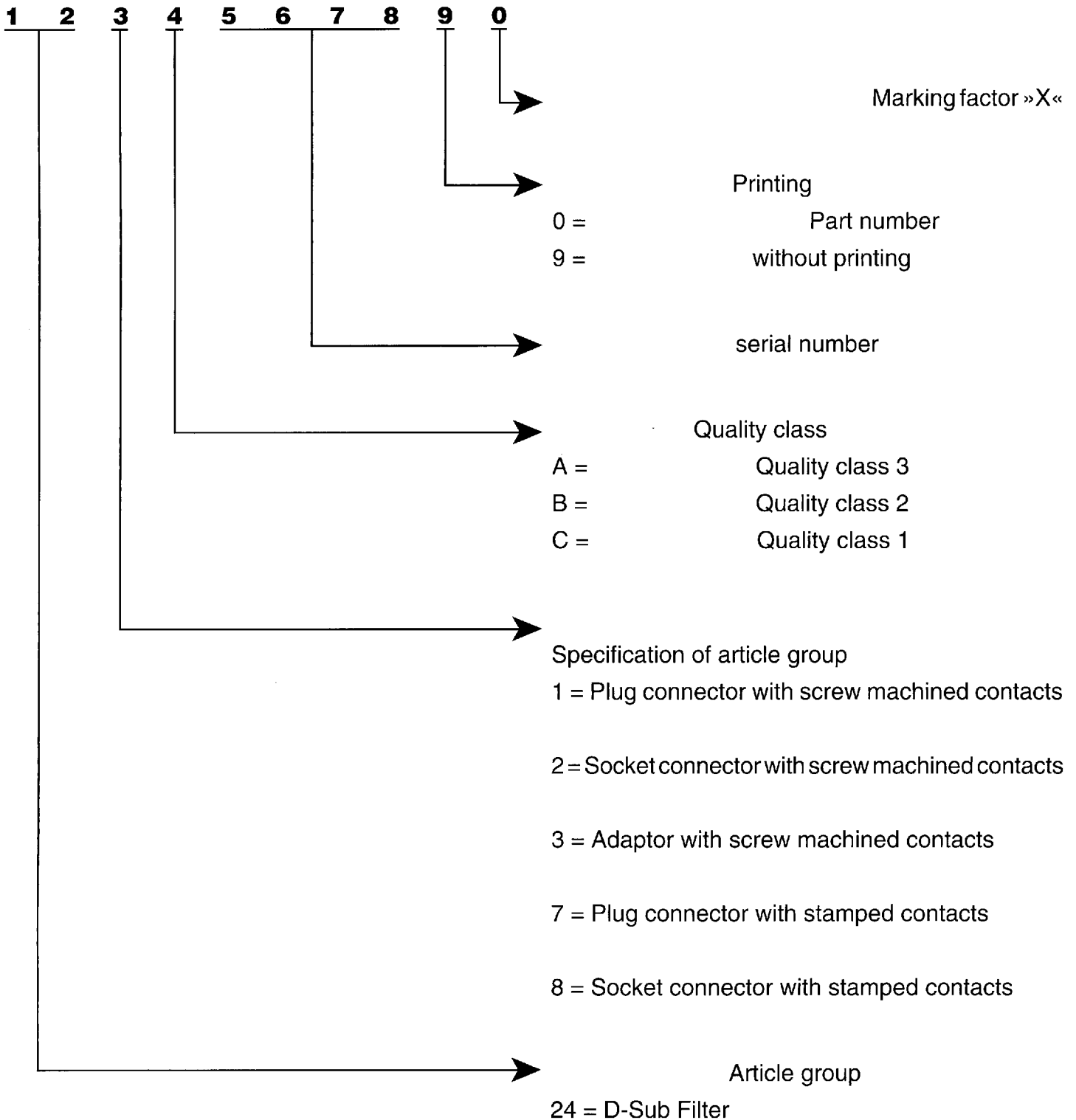

Order example

| Plug connector solder pin angled 25 pos. | | |
|--|-----------------------------|-----------------------|
| Quality class | with screw machine contacts | with stamped contacts |
| 3 | 241 A 12900 X | 247 A 12900 X |
| 2 | 241 B 12900 X | 247 B 12900 X |
| 1 | 241 C 12900 X | 247 C 12900 X |

Hole pattern for angled solder pins D-Sub filter high density

Socket connector solder pin angled

Plug connector solder pin angled

15 pos

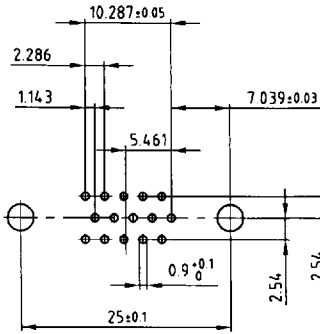

15 pos

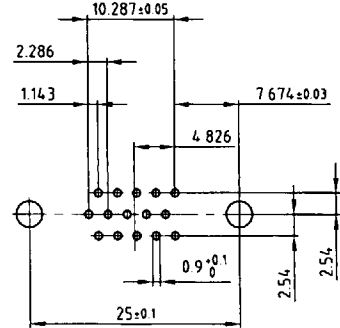

26 pos

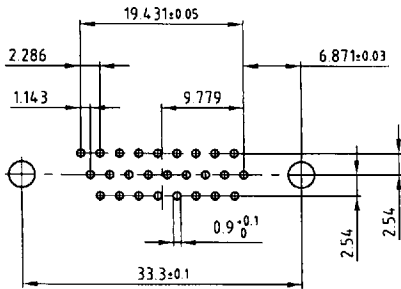

26 pos

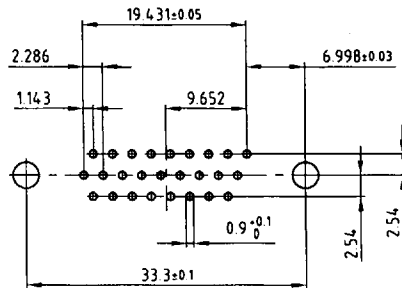

44 pos

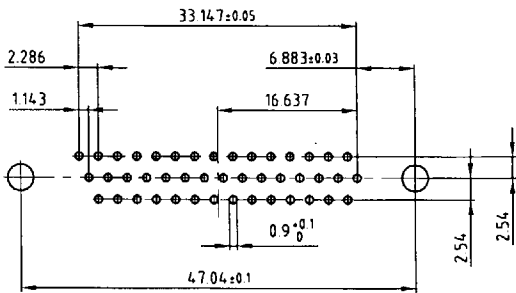

44 pos

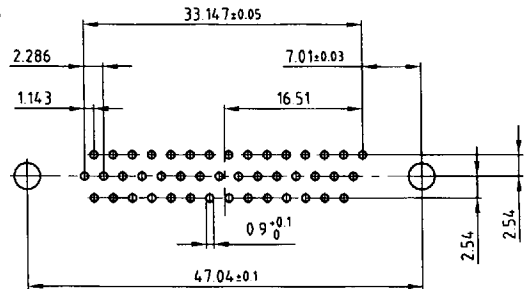

62 pos

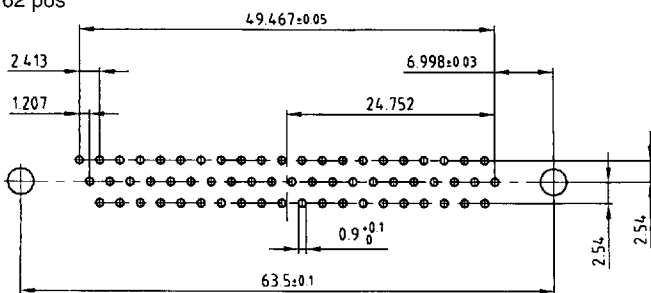

62 pos

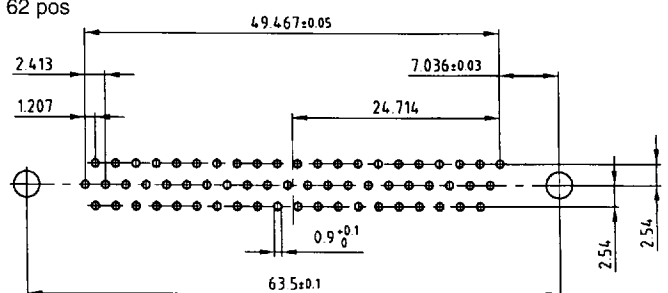

78 pos

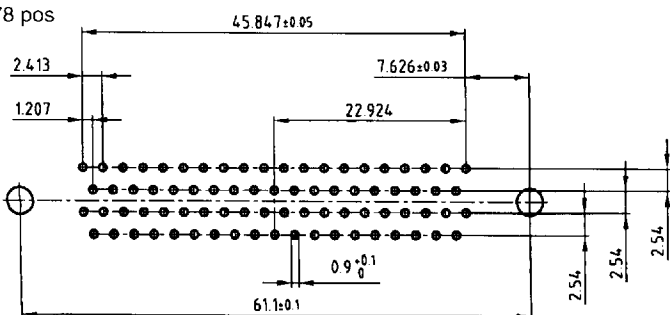

78 pos

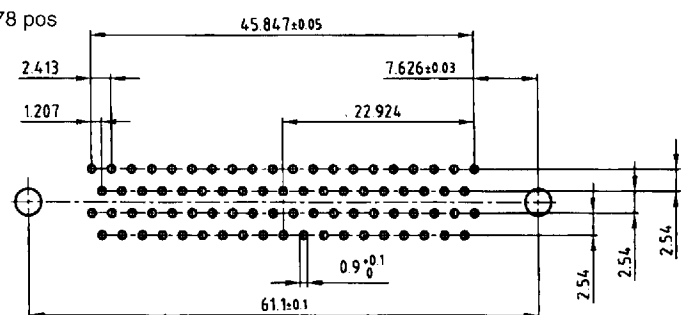

| Technical Data | D-Sub Standard 9,15,25,37,50 pos. | D-Sub High Density 15,26,44,62 pos. |
|---------------------------|---|--|
| Insulators | Polyester GF UL 94 V-0 | PA 6.6 GF 25 UL 94 V-0 |
| Contacts | Copper alloy | |
| Contact finish | hard-gold-plated over nickel, solder area tin plated | |
| Shell | steel tin plated over nickel | |
| Working voltage | 100 V _{DC} Insulation Gr. A according to VDE 0100 * | 60 V _{DC} Insulation Gr. A according to VDE 0100 * |
| Dielectric stand. voltage | 424 V _{DC} standard 707 V _{DC} „high voltage“ | 424 V _{DC} |
| Contact resistance | max. 10mΩ with no load Δ R max. 10 mΩ with load according to din 41652 part. 2 | |
| Insulation resistance | depending on quality class 1 ≥ 10 ¹² Ω 2 ≥ 10 ¹¹ Ω 3 ≥ 10 ⁸ Ω | |
| Current rating | straight version: 5,0 A (20° C) angled version: 2,5 A (20° C) | straight version: 3,0 A (20° C) angled version: 2,5 A (20° C) |
| Voltage surge 10/750 μs | 300 V standard 500 V „high voltage“ | 300 V standard |
| Mating-/ unmating forces | 9-pol. ≤ 30/29 N 15-pol. ≤ 50/33 N 25-pol. ≤ 83/56 N 37-pol. ≤ 123/82 N 50-pol. ≤ 167/111 N | 15-pol. ≤ 50/33 N 26-pol. ≤ 83/56 N 44-pol. ≤ 110/74 N |
| Temperature range storage | - 55° C /to + 125° C | |
| Temperature range working | - 25° C /to + 105° C | - 25° C /to + 85° C |
| Humidity | 40° C / 85% relative | |
| Capacitor values | /type 1 min. 144 pF max. 216 pF /type 2 min. 240 pF max. 360 pF /type 3 min. 296 pF max. 444 pF /type 4 min. 664 pF max. 996 pF /type 5 min. 1040 pF max. 1560 pF | /type 3 min. 296 pF max. 444 pF /type 4 min. 664 pF max. 996 pF |
| Quality class | /Quality class 3 = 50 mating cycles /Quality class 2 = 200 mating cycles /Quality class 1 = 500 mating cycles | |

X-ON Electronics

Largest Supplier of Electrical and Electronic Components

Click to view similar products for [D-Sub Standard Connectors](#) category:

Click to view products by [CONEC](#) manufacturer:

Other Similar products are found below :

[56F711-015](#) [012-9507-004](#) [LV242999-142T12](#) [015-0341-000](#) [015-0349-000](#) [015-0372-005](#) [015-0372-008](#) [015-8755-001](#) [020419-0104](#) [012-0467-000](#) [012-0515-000](#) [012-9507-034](#) [012-9507-114](#) [020745-0008](#) [609-25P](#) [M24308/2-23Z](#) [CT2-14S-2PCA34](#) [CT2-18-11PCAU](#) [CT2-36-15SC](#) [CT6-14S-2SC](#) [CT6E14SA7SC](#) [CT6E22-14PC](#) [CT6E22-14PS](#) [CT6E22-22PS](#) [M83513/01-FC](#) [M85049/48-3-2F](#) [6STD09PCM99B70X](#) [6STD09SCM99B30X](#) [6STD09SCT99S40X](#) [6STD15PCT99S40X](#) [6STD15SCM99B30X](#) [6STD15SCT99S40X](#) [6STF09PCM05B70X](#) [7-135760-9](#) [MC11E-10-6SN](#) [747552-3](#) [MD1-21PS](#) [MDM-15SCBRM7-F222](#) [MDM96517-699](#) [MDM96521-744](#) [MDVB1-21SL1](#) [MIK0-1-7SH003](#) [MIKQ6-7SH076](#) [MIKQ7-7PH077](#) [MIKQ7-7PH11](#) [MIKQ7-7PH32](#) [MIKQ9-7PH003](#) [MJSV-28SL61](#) [MKJ4A1F14-55S](#) [8-135760-3](#)