

used for: D-SUB COMBINATION

5:1

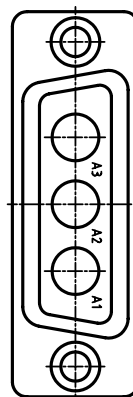
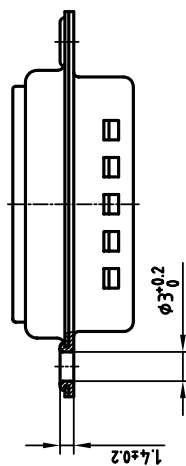
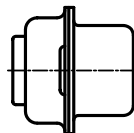
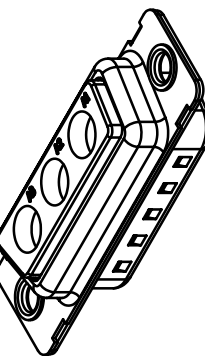
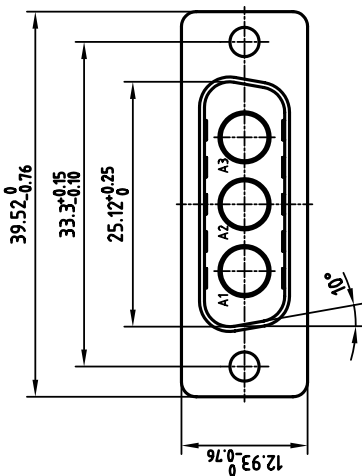
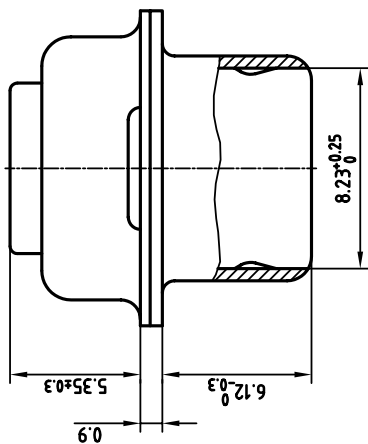

**NOTES:**

1. METAL SHELLS: STEEL, TIN PLATED
2. INSULATOR: PBT GF, UL 94 V-0; GREEN

tolerance		scale: 2:1 (5:1)		material: SEE NOTES	
2000	date	name	title: D-SUB COMBINATION MALE		
drawn	02.03.	E. Mickenbecker	3W3P		
appd.	02.03.	J. Mickenbecker	WITHOUT CONTACTS		
norm			dwg no: 13K2119A		
e-old			[CAD/ REL:14] DIN-A 3		
			sh:2/2		
			product no: 3003W3PXX99A10X		
<b>CONEC®</b>					
rev.	description	date	name		
DO NOT ALTER CAD DRAWING BY HAND					
OWNERSHIP AND COPYRIGHT OF CONEC GMBH					
WRITTEN PERMISSION					
BE PASSED ON TO A THIRD PARTY WITHOUT					
REPRODUCED IN ANY WAY, AND MAY NOT					
THIS DRAWING MAY NOT BE COPIED OR					

used for: D-SUB COMBINATION

5:1

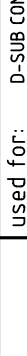

used for: D-SUB COMBINATION

5:1

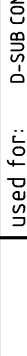

used for: D-SUB COMBINATION

5:1

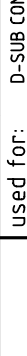

used for: D-SUB COMBINATION

5:1

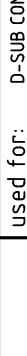

used for: D-SUB COMBINATION

5:1

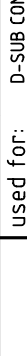

used for: D-SUB COMBINATION

5:1

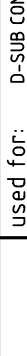

used for: D-SUB COMBINATION

5:1

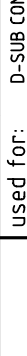

used for: D-SUB COMBINATION

5:1

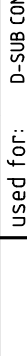

used for: D-SUB COMBINATION

5:1

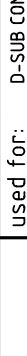

used for: D-SUB COMBINATION

5:1

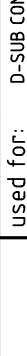

used for: D-SUB COMBINATION

5:1

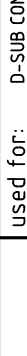

used for: D-SUB COMBINATION

5:1

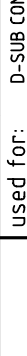

used for: D-SUB COMBINATION

5:1

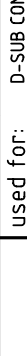

used for: D-SUB COMBINATION

5:1

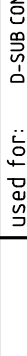

used for: D-SUB COMBINATION

5:1

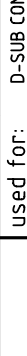

used for: D-SUB COMBINATION

5:1

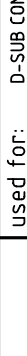

used for: D-SUB COMBINATION

5:1

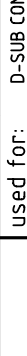

used for: D-SUB COMBINATION

5:1

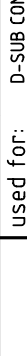

used for: D-SUB COMBINATION

5:1

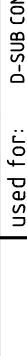

used for: D-SUB COMBINATION

5:1

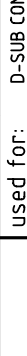

used for: D-SUB COMBINATION

5:1

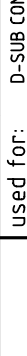

used for: D-SUB COMBINATION

5:1

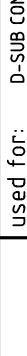

used for: D-SUB COMBINATION

5:1

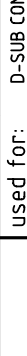

used for: D-SUB COMBINATION

5:1

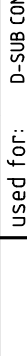

used for: D-SUB COMBINATION

5:1

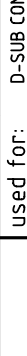

used for: D-SUB COMBINATION

5:1

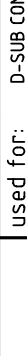

used for: D-SUB COMBINATION

5:1

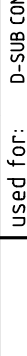

used for: D-SUB COMBINATION

5:1

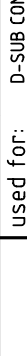

used for: D-SUB COMBINATION

5:1

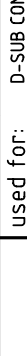

used for: D-SUB COMBINATION

5:1

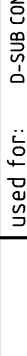

used for: D-SUB COMBINATION

5:1

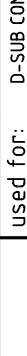

used for: D-SUB COMBINATION

5:1

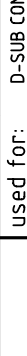

used for: D-SUB COMBINATION

5:1



## X-ON Electronics

Largest Supplier of Electrical and Electronic Components

*Click to view similar products for [D-Sub Mixed Contact Connectors](#) category:*

*Click to view products by [CONEC](#) manufacturer:*

Other Similar products are found below :

[790-025SF-5P5NMN](#) [790-025SJ-7P7NML](#) [DAM-7W2PC](#) [L717TWB5W5P3R](#) [L717TWB5W5PRM84](#) [L717TWP3W3P](#)  
[3003W3PXX56N40X](#) [3005W5PXX99E40X](#) [3005W5SXX99A30X](#) [3005W5SXX99E40X](#) [3013W6SCM99A10X](#) [3036W4PCM41A10X](#)  
[3036W4SCM99A10X](#) [FCE17-E2W2SS-2N0](#) [212522-7](#) [PII-468-1](#) [3003W3PXX43A10X](#) [3003W3SXX56N40X](#) [3005W5PXX88N40X](#)  
[3008W8SXX57A30X](#) [3009W4PCT57P20X](#) [3017W2SAR69C40X](#) [3024W7SCM99A10X](#) [302W2CPXX56N40X](#) [321WA4PXK99A60X](#)  
[321WA4SCT56N40X](#) [3F3SSC22S41A30X](#) [L717TWA7W2PP2SY3R](#) [DBM-17W2S-1A8N-A190-A197-1](#) [421WA4PCR50E20X](#)  
[09693009176](#) [09693909015](#) [6017W2PCM41B30X](#) [790-061SH-36W2NMNA](#) [790-044SE-7P3MNPB](#) [790-043PE-11P2MPA](#) [790-043PB-](#)  
[2P2MPB](#) [790-029SB-2P2MEPA](#) [790-028PK-9P9MPA](#) [790-028PH-54P2MGA](#) [790-028PH-36P2MNA](#) [790-028PB-2P2MPA](#) [790-027SH-](#)  
[5W5MTEP](#) [790-026PH-54P2ZNUG](#) [790-026PH-54P2MP](#) [790-026PH-36P2ZNUG](#) [790-026PH-36P2MG](#) [790-026PD-3P3MP](#) [790-025SJ-](#)  
[7P7EMS](#) [790-025SH-36W2NMT](#)